

KEY FEATURES

- Switching Power Modules for PCB Mounting
- Fully Encapsulated Plastic Case
- Universal Input Range 90-264VAC, 47-440 Hz
- Regulated Output
- Low Ripple and Noise
- Isolation Class II
- CE, CB, UL, cUL, Approvals
- 3-Year Product Warranty

ELECTRICAL SPECIFICATIONS

Model No. (Single Output)	MSC-3.3S -E1	MSC-5S -E1	MSC-9S -E1	MSC-12S -E1	MSC-15S -E1	MSC-24S -E1	
Max output wattage (W)	26.4W	40W	40W	40W	40W	40W	
Output	Voltage (V.DC.)	3.3V	5V	9V	12V	15V	24V
	Current (mA) max	8000	8000	4444	3333	2666	1667
	Voltage set accuracy	±2%	±2%	±2%	±2%	±2%	±2%
	Line regulation (typ.)	0.5%	0.5%	0.5%	0.5%	0.5%	0.5%
	Load regulation (1-100%) (typ.)	1%	1%	1%	1%	1%	1%
	Minimum load	1%	1%	1%	1%	1%	1%
	Efficiency (typ.)	74%	79%	82%	83%	83%	83%
	Maximum Capacitive Load (at 230 VAC)	70000 uF	33000 uF	10000 uF	4000 uF	3000 uF	1200 uF

Model No. (Dual Output)	MSC-5D-E1		MSC-12D-E1		MSC-15D-E1		
Max output wattage (W)	40W		40W		40W		
Output	Output 1	Output 2	Output 1	Output 2	Output 1	Output 2	
	Voltage (V.DC.)	+5V	-5V	+12V	-12V	+15V	-15V
	Current (mA) max	4000	4000	1666	1666	1333	1333
	Voltage set accuracy	±2%		±2%		±2%	
	Line regulation (typ.)	0.5%		0.5%		0.5%	
	Load regulation (10-100%) (typ.)	1% (symmetric load)		1% (symmetric load)		1% (symmetric load)	
	Cross regulation (typ.)	5%		5%		5%	
	Minimum load	10%		10%		10%	
	Efficiency (typ.)	80%		83%		83%	
	Maximum Capacitive Load (at 230 VAC)	±6000 uF		±1000 uF		±2000 uF	

Model No. (Dual Output)	MSC-5S12S-E1		MSC-5S24S-E1		
Max output wattage (W)	40W		40W		
Output	Output 1	Output 2	Output 1	Output 2	
	Voltage (V.DC.)	5V	12V	5V	24V
	Current (mA) max	5000	1250	5000	625
	Voltage set accuracy	±3%	±5%	±3%	±5%
	Line regulation (typ.)	0.5%	5%	0.5%	5%
	Load regulation (10-100%) (typ.)	2% (symmetric load)	6% (symmetric load)	2% (symmetric load)	6% (symmetric load)
	Cross regulation (typ.)	1%	7%	1%	7%
	Minimum load	25%		25%	
	Efficiency (typ.)	80%		80%	
	Maximum Capacitive Load (at 230 VAC)	15000 uF / 750 uF		15000 uF / 200 uF	

ELECTRICAL SPECIFICATIONS

Model No. (Triple Output)		MSC-5S12D-E1			MSC-5S15D-E1	
Max output wattage (W)		40W			40W	
Output		Output 2	Output 3	Output 1	Output 2	Output 3
	Voltage (V.DC.)	+12	-12	5	+15	-15
	Current (mA) max	600	600	5000	500	500
	Voltage set accuracy	±5%		±3%	±5%	
	Line regulation (typ.)	5%		0.5%	5%	
	Load regulation (25-100%) (typ.) (symmetric load)	7%		3%	7%	
	Cross regulation (typ.)	7%		3%	7%	
	Minimum load	25%			25%	
	Efficiency (typ.)	79%			79%	
	Maximum Capacitive Load (at 230 VAC)	±150 uF		18000 uF	±400 uF	

ELECTRICAL SPECIFICATIONS

All specifications valid at normal input voltage, full load and +25°C after warm-up time unless otherwise stated.

Input	Voltage	90-264 VAC or 100-375 VDC
	Frequency (Hz)	47-440 Hz
	Current (Full load)	860 mA max. (115 VAC) / 460 mA max. (230 VAC)
	Inrush current (<2ms)	55 A max. (115 VAC) / 95 A max. (230 VAC)
	Leakage Current	< 0.1mA / 264 VAC (Touch Current)
	External fuse (recommend)	3.15 A slow blow type
Output	Ripple & Noise	3.3V : 50mV of Vout others : 1% of Vout
	Hold-up time	18 ms min.
Protection	Over current protection	Above 105% rated output power
	Over voltage protection	Zener diode clamp
	Short circuit protection	Hiccup mode, indefinite (automatic recovery)
	OTP	100°C
Isolation	Input-Output (V.AC)	4000V
Environment	Operating temperature	-40°C...+70°C (Case Temperature max. +95°C)
	Storage temperature	-40°C...+85°C
	Temperature coefficient	0.01%/°C
	Humidity	95% RH
	MTBF	200,000 h~400,000 h @ 25°C
Physical	Dimension (L x W x H)	3.5 x 2.5 x 1.06 Inches (89.0 x 63.5 x 27.0 mm) Tolerance ±0.5 mm
	Case Material	Plastic resin (flammability to UL 94V-0)
	Weight	280 g
	Cooling method	Free air convection
Safety & EMC	Class II	To IEC / EN 60536
	Approval	cUL / UL / CB / ANSI/AAMI ES 60601-1: 2005, 1st Edition and CAN/CSA-C22.2 No. 60601-1:08, 2nd Edition, 2XMOPP
	EMI	EN 55011 class B
	EMC Standards	EN60601-1-2
	ESD Susceptibility	EN60601-1-2
	Radiated Susceptibility	EN60601-1-2
	EFT / Burst	EN60601-1-2
	Surge	EN60601-1-2
	Conducted Susceptibility	EN60601-1-2
Safety Approvals	EN60601-1	

NOTE

1. Ripple & Noise are measured at 20MHz of bandwidth with 0.1uF & 47uF parallel capacitor.
2. It's recommended to add Varistor 14S471K at L / N input side in parallel.
3. Please refer to our PDF file "AC-DC Application" on our website: www.archcorp.com.tw

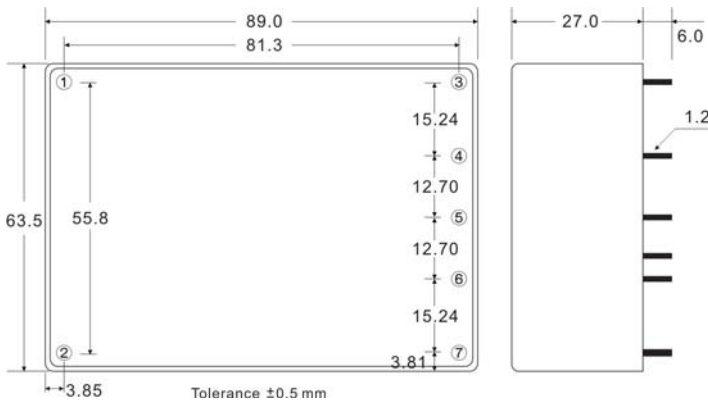
MECHANICAL DIMENSION (Top View)

PIN#	Single	Dual	5S/12S 5S/24S	Triple
1	AC IN (L)	AC IN (L)	AC IN (L)	AC IN (L)
2	AC IN (N)	AC IN (N)	AC IN (N)	AC IN (N)
3	+DC OUT	+DC OUT	+OUT2	+DC OUT
4	NO PIN	NO PIN	+OUT1	+5V
5	-DC OUT	COMMON	+OUT2 RTN	COMMON
6	NO PIN	NO PIN	+OUT1 RTN	+5 RTN
7	NOCONNECT	-DC OUT	NO PIN	-DC OUT

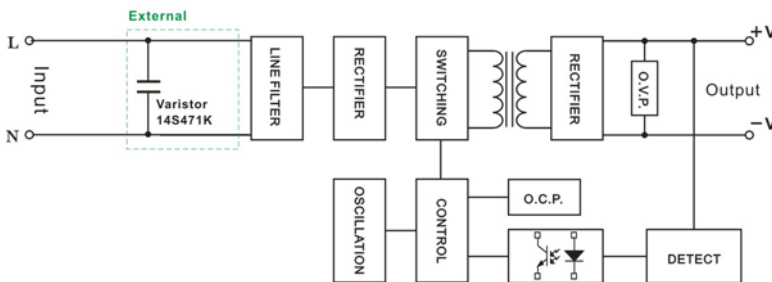
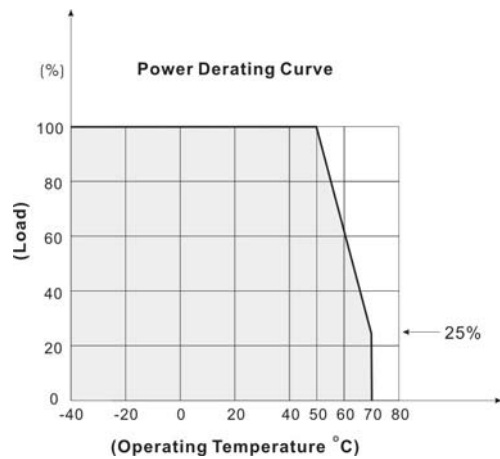
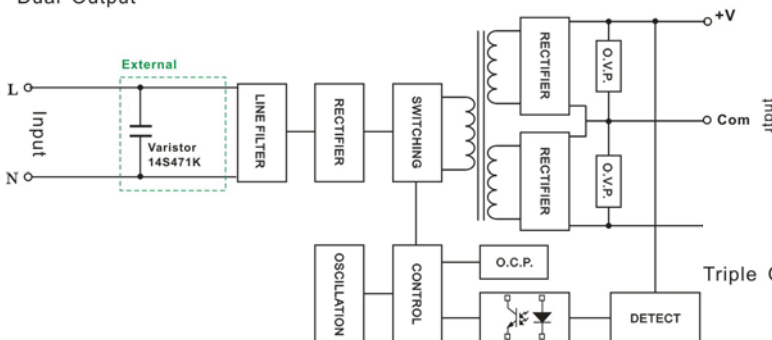
BLOCK DIAGRAM
Single Output

DERATING

Dual Output

Triple Output
