

# 200MHz, CMOS OPERATIONAL AMPLIFIER WITH SHUTDOWN

## FEATURES

- **UNITY-GAIN BANDWIDTH: 450MHz**
- **WIDE BANDWIDTH: 200MHz GBW**
- **HIGH SLEW RATE: 360V/ $\mu$ s**
- **LOW NOISE: 5.8nV/ $\sqrt{\text{Hz}}$**
- **EXCELLENT VIDEO PERFORMANCE:**  
DIFF GAIN: 0.02%, DIFF PHASE: 0.05°  
0.1dB GAIN FLATNESS: 75MHz
- **INPUT RANGE INCLUDES GROUND**
- **RAIL-TO-RAIL OUTPUT (within 100mV)**
- **LOW INPUT BIAS CURRENT: 3pA**
- **LOW SHUTDOWN CURRENT: 3.4 $\mu$ A**
- **ENABLE/DISABLE TIME: 100ns/30ns**
- **THERMAL SHUTDOWN**
- **SINGLE-SUPPLY OPERATING RANGE: 2.5V to 5.5V**
- **MicroSIZE PACKAGES**

## APPLICATIONS

- VIDEO PROCESSING
- ULTRASOUND
- OPTICAL NETWORKING, TUNABLE LASERS
- PHOTODIODE TRANSIMPEDANCE AMPS
- ACTIVE FILTERS
- HIGH-SPEED INTEGRATORS
- ANALOG-TO-DIGITAL (A/D) CONVERTER INPUT BUFFERS
- DIGITAL-TO-ANALOG (D/A) CONVERTER OUTPUT AMPLIFIERS
- BARCODE SCANNERS
- COMMUNICATIONS

## DESCRIPTION

The OPA355 series high-speed, voltage-feedback CMOS operational amplifiers are designed for video and other applications requiring wide bandwidth. The OPA355 is unity-gain stable and can drive large output currents. In addition, the OPA355 has a digital shutdown (Enable) function. This feature provides power savings during idle periods and places the output in a high-impedance state to support output multiplexing. Differential gain is 0.02% and differential phase is 0.05°. Quiescent current is only 8.3mA per channel.

The OPA355 is optimized for operation on single or dual supplies as low as 2.5V ( $\pm 1.25\text{V}$ ) and up to 5.5V ( $\pm 2.75\text{V}$ ). Common-mode input range for the OPA355 extends 100mV below ground and up to 1.5V from V+. The output swing is within 100mV of the rails, supporting wide dynamic range.

The OPA355 series is available in single (SOT23-6 and SO-8), dual (MSOP-10), and triple (TSSOP-14 and SO-14) versions. Multichannel versions feature completely independent circuitry for lowest crosstalk and freedom from interaction. All are specified over the extended  $-40^{\circ}\text{C}$  to  $+125^{\circ}\text{C}$  range.

## OPA355 RELATED PRODUCTS

FEATURES	PRODUCT
200MHz, Rail-to-Rail Output, CMOS, No Shutdown	OPA356
38MHz, Rail-to-Rail Input/Output, CMOS	OPAx350
75MHz, Rail-to-Rail Output	OPAx631
150MHz, Rail-to-Rail Output	OPAx634
Differential Input/Output, 3.3V Supply	THS412x

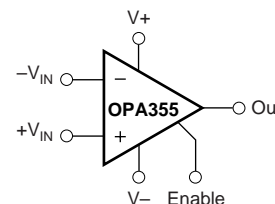

Please be aware that an important notice concerning availability, standard warranty, and use in critical applications of Texas Instruments semiconductor products and disclaimers thereto appears at the end of this data sheet.

All trademarks are the property of their respective owners.

## ABSOLUTE MAXIMUM RATINGS<sup>(1)</sup>

Supply Voltage, V+ to V- .....	7.5V
Signal Input Terminals, Voltage <sup>(2)</sup> .....	(V-) - 0.5V to (V+) + 0.5V
Current <sup>(2)</sup> .....	10mA
Enable Input .....	(V-) - 0.5V to (V+) + 0.5V
Output Short-Circuit <sup>(3)</sup> .....	Continuous
Operating Temperature .....	-55°C to +150°C
Storage Temperature .....	-65°C to +150°C
Junction Temperature .....	+160°C
Lead Temperature (soldering, 10s) .....	+300°C

NOTES: (1) Stresses above these ratings may cause permanent damage. Exposure to absolute maximum conditions for extended periods may degrade device reliability. These are stress ratings only, and functional operation of the device at these or any other conditions beyond those specified is not implied. (2) Input terminals are diode-clamped to the power-supply rails. Input signals that can swing more than 0.5V beyond the supply rails should be current limited to 10mA or less. (3) Short-circuit to ground, one amplifier per package.



## ELECTROSTATIC DISCHARGE SENSITIVITY

This integrated circuit can be damaged by ESD. Texas Instruments recommends that all integrated circuits be handled with appropriate precautions. Failure to observe proper handling and installation procedures can cause damage.

ESD damage can range from subtle performance degradation to complete device failure. Precision integrated circuits may be more susceptible to damage because very small parametric changes could cause the device not to meet its published specifications.

## PACKAGE/ORDERING INFORMATION<sup>(1)</sup>

PRODUCT	PACKAGE-LEAD	PACKAGE MARKING
OPA355	SOT23-6	C55
"	"	"
OPA355	SO-8	OPA355UA
"	"	"
OPA2355	MSOP-10	D55
"	"	"
OPA3355	TSSOP-14	OPA3355EA
"	"	"
OPA3355	SO-14	OPA3355UA
"	"	"

NOTE: (1) For the most current package and ordering information, see the Package Option Addendum located at the end of this data sheet.

## PIN CONFIGURATIONS

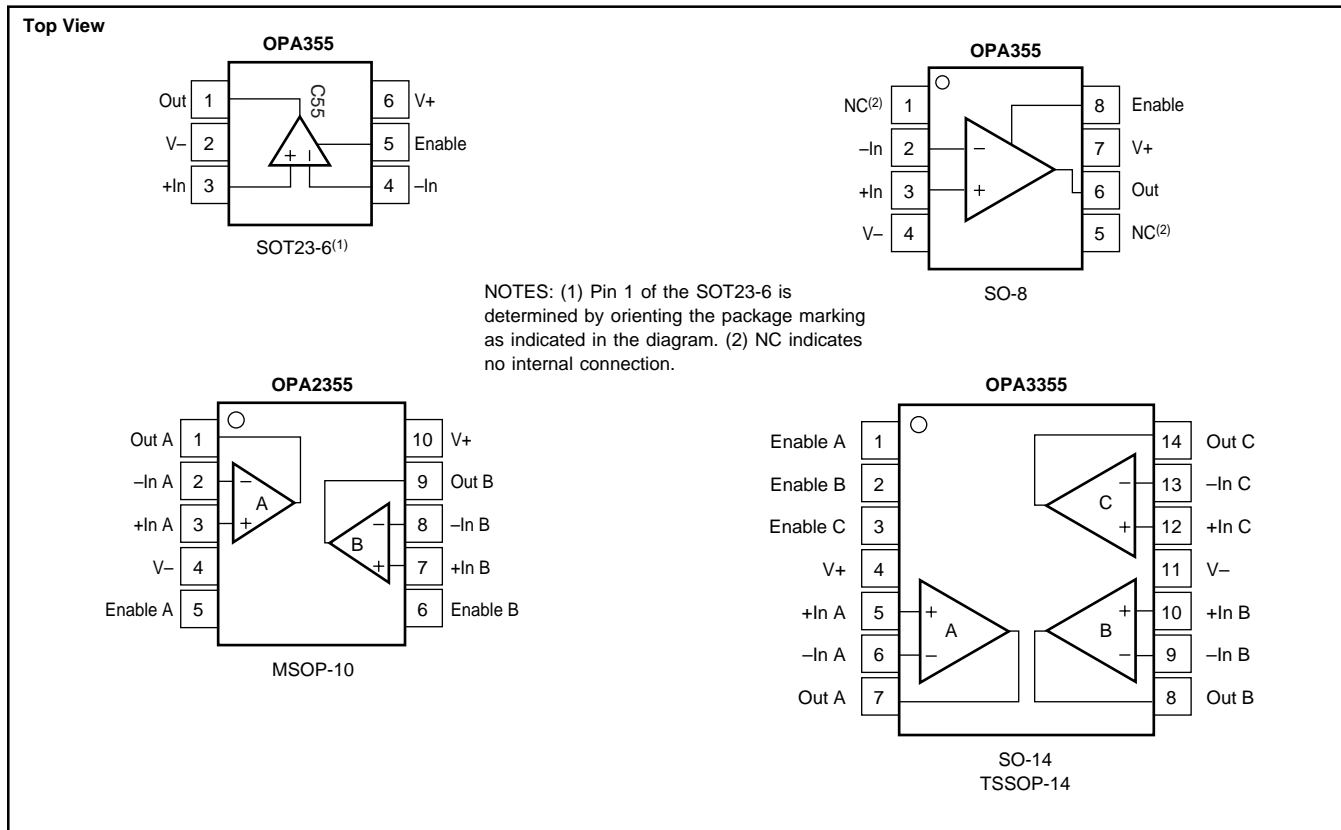

# ELECTRICAL CHARACTERISTICS: $V_S = +2.7V$ to $+5.5V$ Single-Supply

**Boldface** limits apply over the specified temperature range,  $T_A = -40^\circ C$  to  $+125^\circ C$ .

At  $T_A = +25^\circ C$ ,  $R_F = 604\Omega$ ,  $R_L = 150\Omega$ , and connected to  $V_S/2$ , unless otherwise noted.

PARAMETER	CONDITION	OPA355 OPA2355 OPA3355			UNITS
		MIN	TYP	MAX	
<b>OFFSET VOLTAGE</b>					
Input Offset Voltage $V_{OS}$	$V_S = +5V$		$\pm 2$	$\pm 9$	mV
<b>vs Temperature</b>	<b>Specified Temperature Range</b>		$\pm 7$	$\pm 15$	mV
<b>vs Power Supply</b>	<b>Specified Temperature Range</b>		$\pm 80$	$\pm 350$	$\mu V/^\circ C$
	$V_S = +2.7V$ to $+5.5V$ , $V_{CM} = V_S/2 - 0.15V$				$\mu V/V$
<b>INPUT BIAS CURRENT</b>					
Input Bias Current $I_B$			3	$\pm 50$	pA
Input Offset Current $I_{OS}$			$\pm 1$	$\pm 50$	pA
<b>NOISE</b>					
Input Noise Voltage Density $e_n$	$f = 1MHz$		5.8		$nV/\sqrt{Hz}$
Current Noise Density $i_n$	$f = 1MHz$		50		$fA/\sqrt{Hz}$
<b>INPUT VOLTAGE RANGE</b>					
Common-Mode Voltage Range $V_{CM}$		$(V-) - 0.1$		$(V+) - 1.5$	V
Common-Mode Rejection Ratio CMRR	$V_S = +5.5V$ , $-0.1V < V_{CM} < +4.0V$	66	80		dB
	<b>Specified Temperature Range</b>	<b>66</b>			<b>dB</b>
<b>INPUT IMPEDANCE</b>					
Differential			$10^{13} \parallel 1.5$		$\Omega \parallel pF$
Common-Mode			$10^{13} \parallel 1.5$		$\Omega \parallel pF$
<b>OPEN-LOOP GAIN</b>					
	$V_S = +5V$ , $0.3V < V_O < 4.7V$	84	92		dB
	<b>OPA355</b> <b><math>V_S = +5V</math>, <math>0.3V &lt; V_O &lt; 4.7V</math></b>	<b>80</b>			<b>dB</b>
	<b>OPA2355, OPA3355</b> <b><math>V_S = +5V</math>, <math>0.4V &lt; V_O &lt; 4.6V</math></b>	<b>80</b>			<b>dB</b>
<b>FREQUENCY RESPONSE</b>					
Small-Signal Bandwidth $f_{-3dB}$	$G = +1$ , $V_O = 100mVp-p$ , $R_F = 0\Omega$		450		MHz
$f_{-3dB}$	$G = +2$ , $V_O = 100mVp-p$ , $R_L = 50\Omega$		100		MHz
$f_{-3dB}$	$G = +2$ , $V_O = 100mVp-p$ , $R_L = 150\Omega$		170		MHz
$f_{-3dB}$	$G = +2$ , $V_O = 100mVp-p$ , $R_L = 1k\Omega$		200		MHz
Gain-Bandwidth Product GBW	$G = +10$ , $R_L = 1k\Omega$		200		MHz
Bandwidth for 0.1dB Gain Flatness $f_{0.1dB}$	$G = +2$ , $V_O = 100mVp-p$ , $R_F = 560\Omega$		75		MHz
Slew Rate SR	$V_S = +5V$ , $G = +2$ , 4V Output Step		300/–360		V/ $\mu s$
Rise-and-Fall Time	$G = +2$ , $V_O = 200mVp-p$ , 10% to 90%		2.4		ns
	$G = +2$ , $V_O = 2Vp-p$ , 10% to 90%		8		ns
Settling Time, 0.1%	$V_S = +5V$ , $G = +2$ , 2V Output Step		30		ns
0.01%	$V_S = +5V$ , $G = +2$ , 2V Output Step		120		ns
Overload Recovery Time	$V_{IN} \cdot Gain = V_S$		8		ns
Harmonic Distortion					
2nd-Harmonic	$G = +2$ , $f = 1MHz$ , $V_O = 2Vp-p$ , $R_L = 200\Omega$		–81		dBc
3rd-Harmonic	$G = +2$ , $f = 1MHz$ , $V_O = 2Vp-p$ , $R_L = 200\Omega$		–93		dBc
Differential Gain Error	NTSC, $R_L = 150\Omega$		0.02		%
Differential Phase Error	NTSC, $R_L = 150\Omega$		0.05		degrees
Channel-to-Channel Crosstalk					
	OPA2355 $f = 5MHz$		–90		dB
	OPA3355 $f = 5MHz$		–70		dB
<b>OUTPUT</b>					
Voltage Output Swing from Rail	$V_S = +5V$ , $R_L = 150\Omega$ , $A_{OL} > 84dB$		0.2	0.3	V
Voltage Output Swing from Rail	$V_S = +5V$ , $R_L = 1k\Omega$		0.1		V
Output Current, Continuous <sup>(1)</sup> $I_O$			$\pm 60$		mA
Output Current, Peak <sup>(1)</sup> $I_O$	$V_S = +5V$		$\pm 100$		mA
Output Current, Peak <sup>(1)</sup> $I_O$	$V_S = +3V$		$\pm 80$		mA
Closed-Loop Output Impedance	$f < 100kHz$		0.02		$\Omega$
<b>POWER SUPPLY</b>					
Specified Voltage Range $V_S$		2.7		5.5	V
Operating Voltage Range			2.5 to 5.5		V
Quiescent Current (per amplifier) $I_Q$	$V_S = +5V$ , Enabled, $I_O = 0$		8.3	11	mA
	<b>Specified Temperature Range</b>			<b>14</b>	<b>mA</b>

NOTES: (1) See typical characteristic *Output Voltage Swing vs Output Current*. (2) Logic LOW and HIGH levels are CMOS logic compatible. They are referenced to  $V_-$ .

# ELECTRICAL CHARACTERISTICS: $V_S = +2.7V$ to $+5.5V$ Single-Supply (Cont.)

**Boldface** limits apply over the specified temperature range,  $T_A = -40^\circ C$  to  $+125^\circ C$ .

At  $T_A = +25^\circ C$ ,  $R_F = 604\Omega$ ,  $R_L = 150\Omega$ , and connected to  $V_S/2$ , unless otherwise noted.

PARAMETER	CONDITION	OPA355 OPA2355 OPA3355			UNITS
		MIN	TYP	MAX	
<b>SHUTDOWN</b>					
Disabled (Logic-LOW Threshold) <sup>(2)</sup>				0.8	V
Enabled (Logic-HIGH Threshold) <sup>(2)</sup>		2			V
Enable Time			100		ns
Disable Time			30		ns
Shutdown Current (per amplifier)	$V_S = +5V$ , Disabled		3.4	6	$\mu A$
<b>THERMAL SHUTDOWN</b>					
Junction Temperature					
Shutdown			160		$^\circ C$
Reset from Shutdown			140		$^\circ C$
<b>TEMPERATURE RANGE</b>					
Specified Range		-40		125	$^\circ C$
Operating Range		-55		150	$^\circ C$
Storage Range		-65		150	$^\circ C$
Thermal Resistance	$\theta_{JA}$				$^\circ C/W$
SOT-23-6, MSOP-10			150		$^\circ C/W$
SO-8			125		$^\circ C/W$
SO-14, TSSOP-14			100		$^\circ C/W$

NOTES: (1) See typical characteristic *Output Voltage Swing vs Output Current*. (2) Logic LOW and HIGH levels are CMOS logic compatible. They are referenced to  $V_-$ .

# TYPICAL CHARACTERISTICS

At  $T_A = +25^\circ\text{C}$ ,  $V_S = 5\text{V}$ ,  $G = +2$ ,  $R_F = 604\Omega$ , and  $R_L = 150\Omega$  connected to  $V_S/2$ , unless otherwise noted.

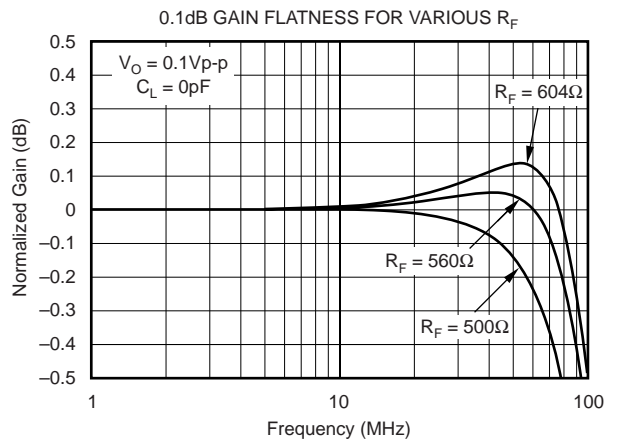
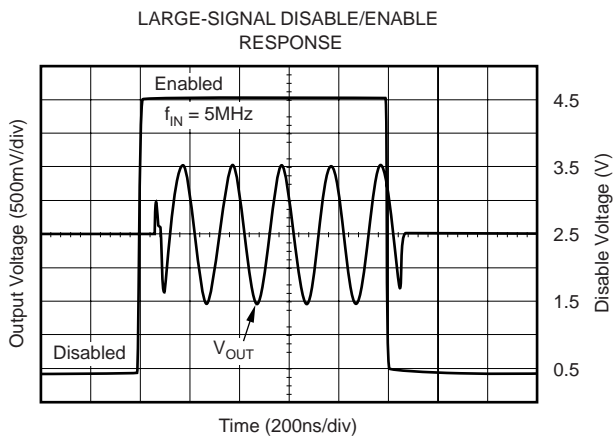
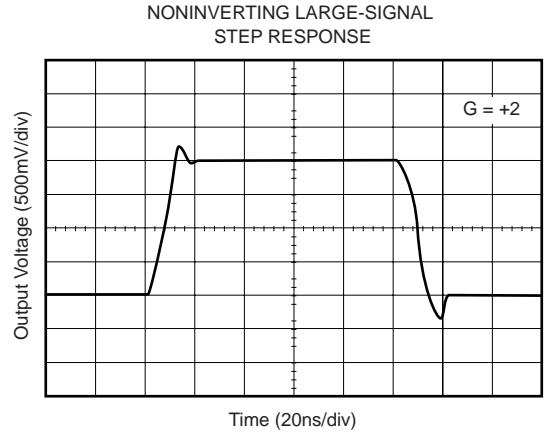
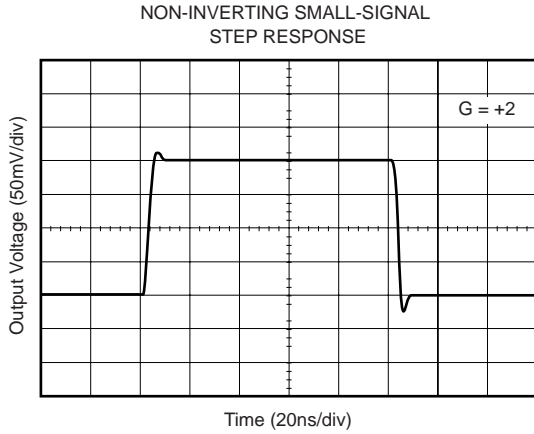
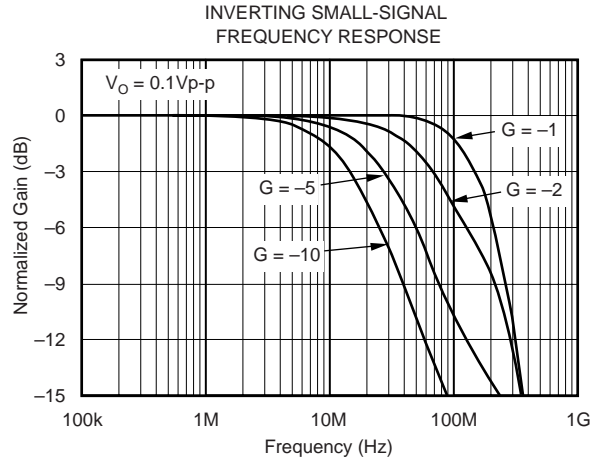
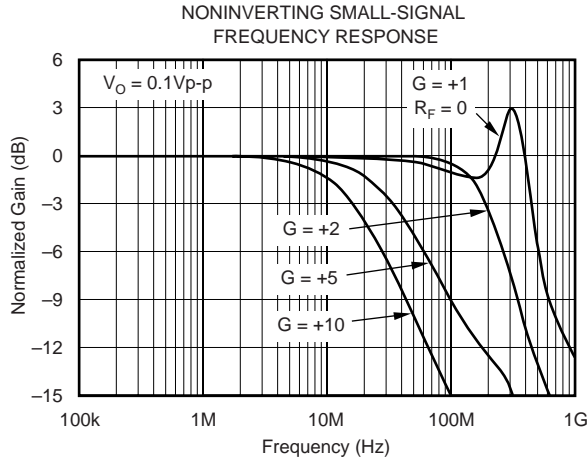

# TYPICAL CHARACTERISTICS (Cont.)

At  $T_A = +25^\circ\text{C}$ ,  $V_S = 5\text{V}$ ,  $G = +2$ ,  $R_F = 604\Omega$ , and  $R_L = 150\Omega$  connected to  $V_S/2$ , unless otherwise noted.

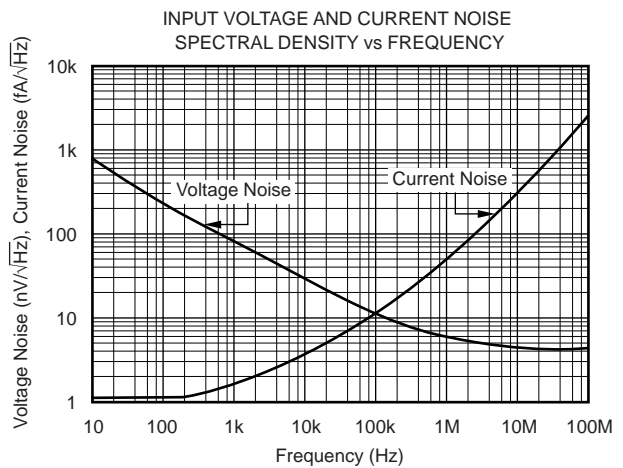
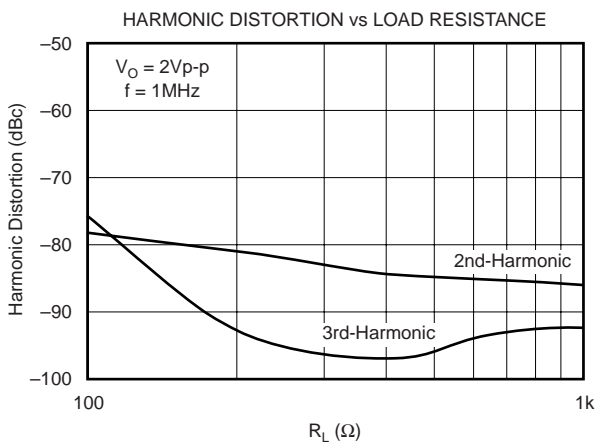
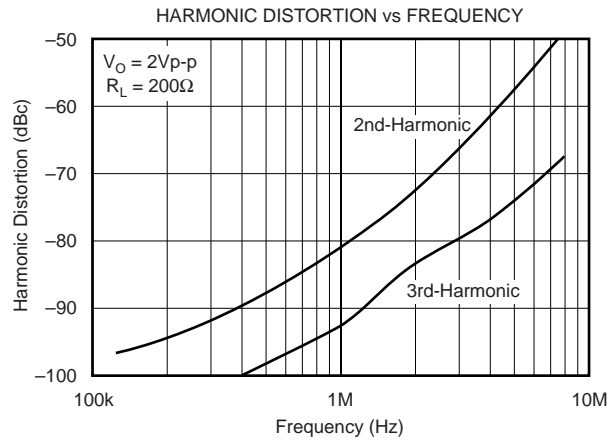
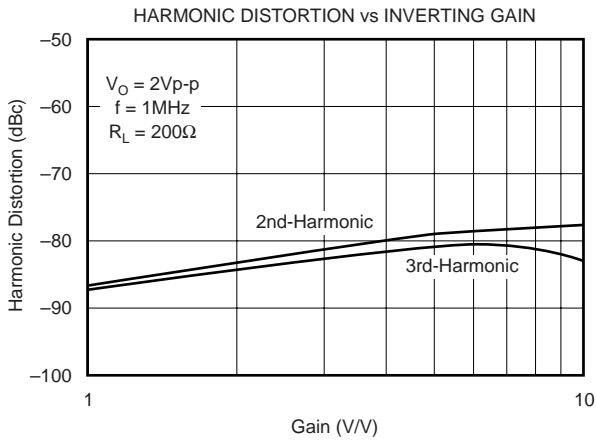
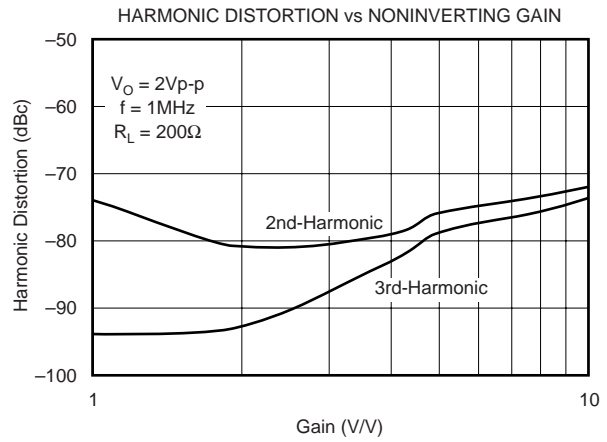
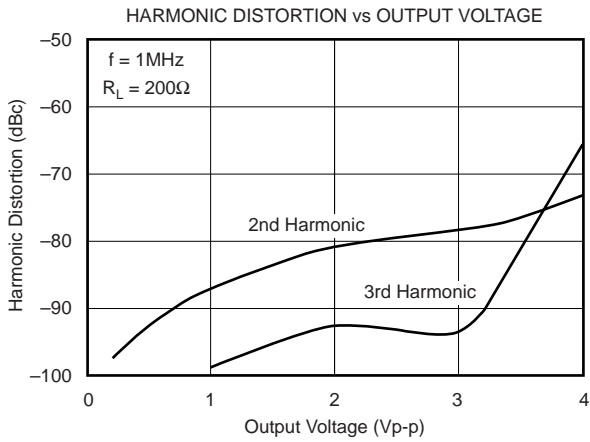

# TYPICAL CHARACTERISTICS (Cont.)

At  $T_A = +25^\circ\text{C}$ ,  $V_S = 5\text{V}$ ,  $G = +2$ ,  $R_F = 604\Omega$ , and  $R_L = 150\Omega$  connected to  $V_S/2$ , unless otherwise noted.

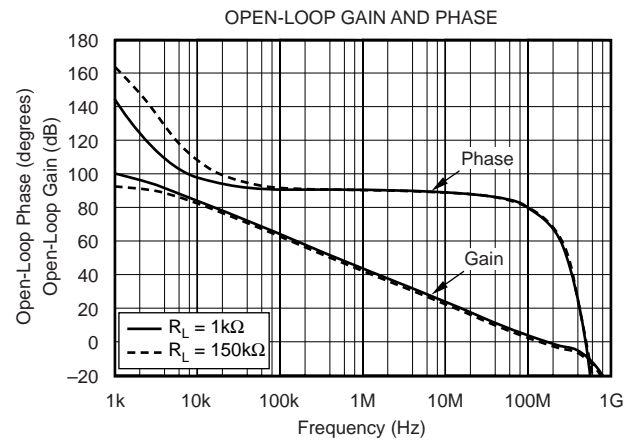
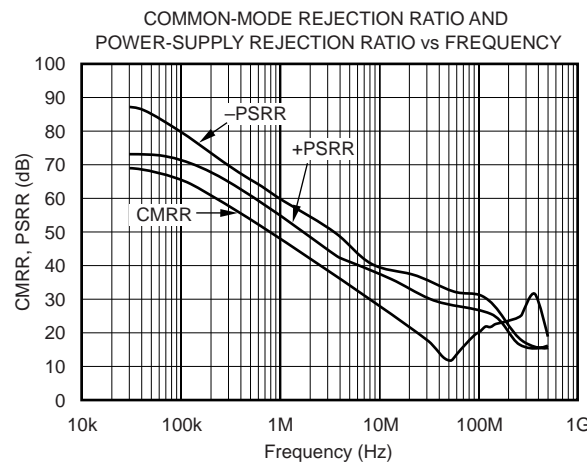
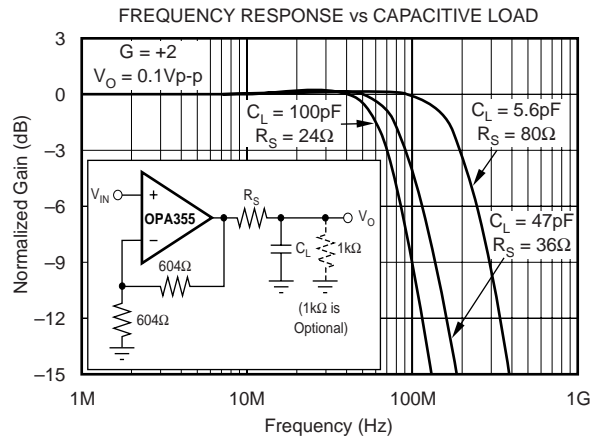
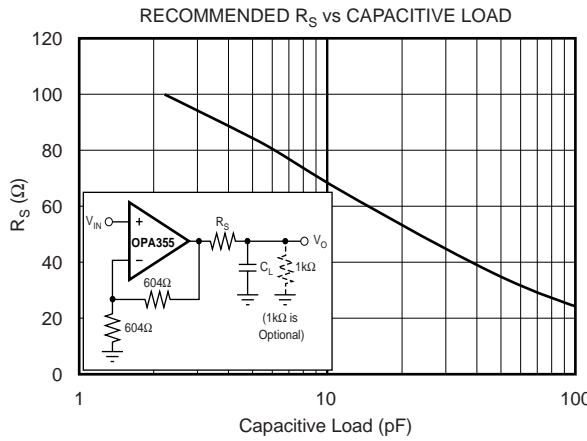
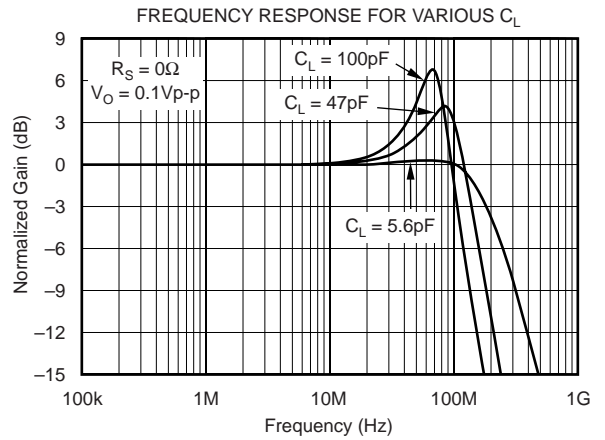
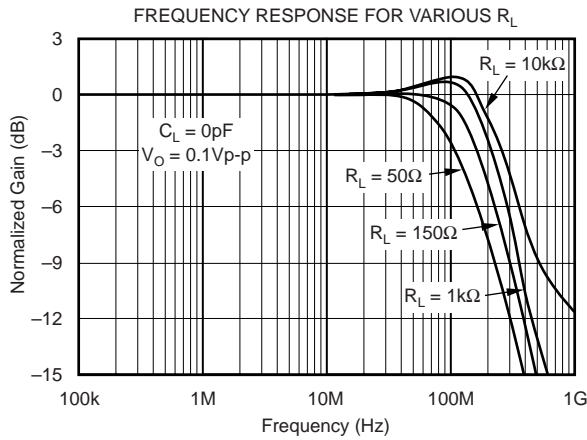

# TYPICAL CHARACTERISTICS (Cont.)

At  $T_A = +25^\circ\text{C}$ ,  $V_S = 5\text{V}$ ,  $G = +2$ ,  $R_F = 604\Omega$ , and  $R_L = 150\Omega$  connected to  $V_S/2$ , unless otherwise noted.

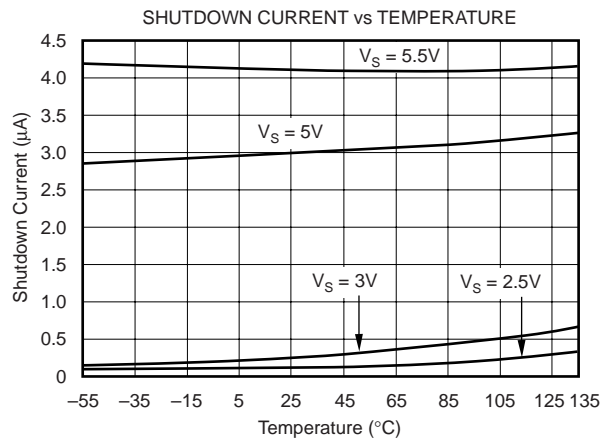
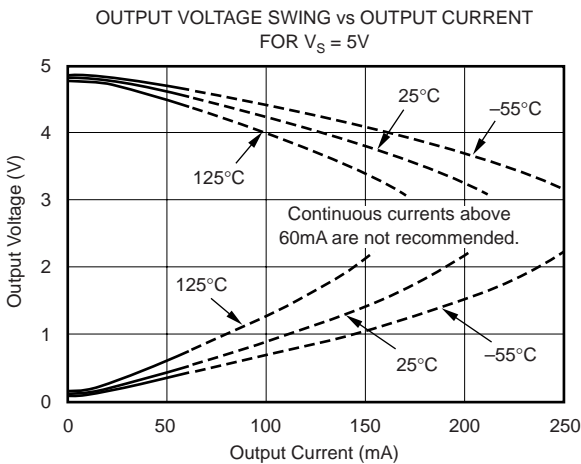
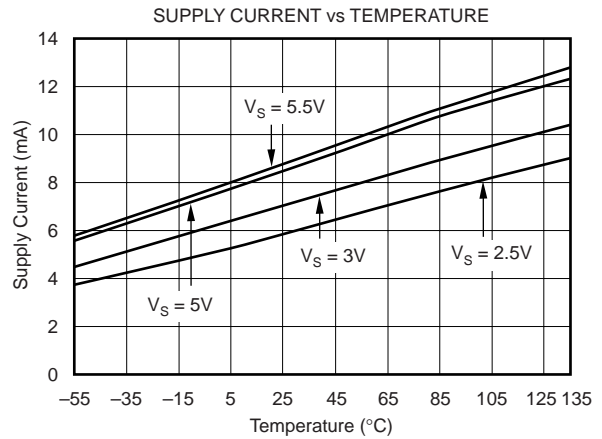
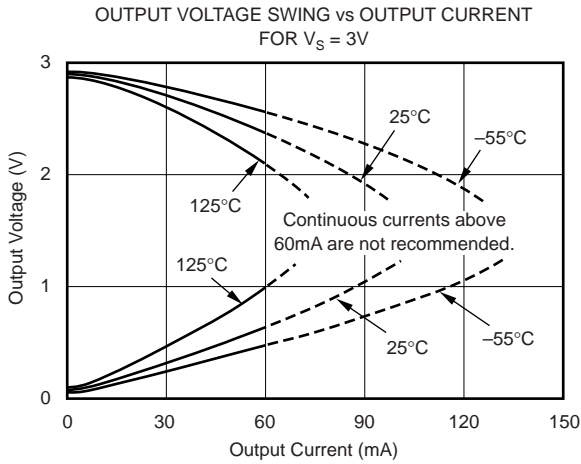
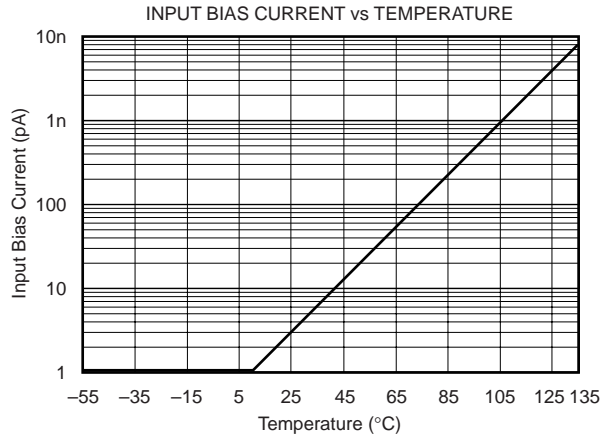
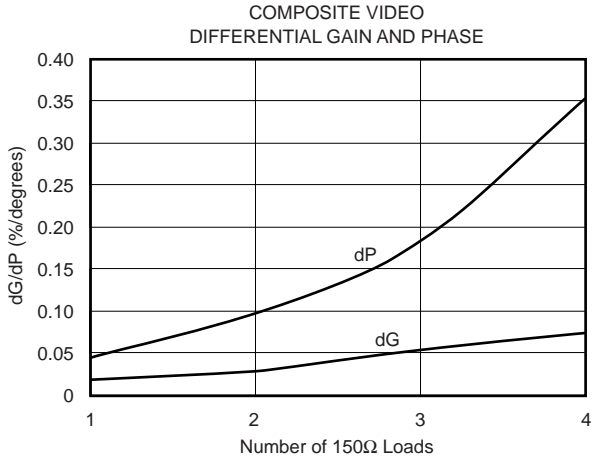



# TYPICAL CHARACTERISTICS (Cont.)

At  $T_A = +25^\circ\text{C}$ ,  $V_S = 5\text{V}$ ,  $G = +2$ ,  $R_F = 604\Omega$ , and  $R_L = 150\Omega$  connected to  $V_S/2$ , unless otherwise noted.

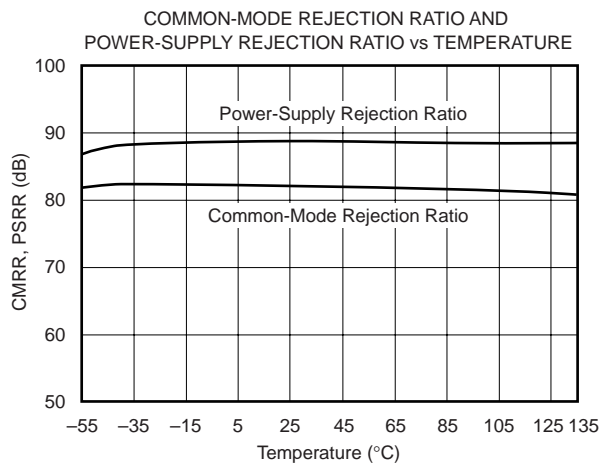
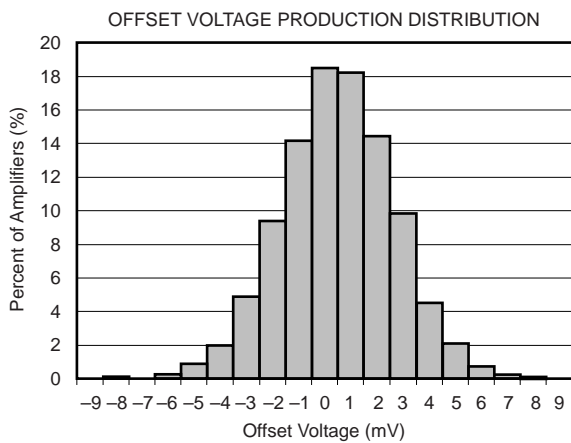
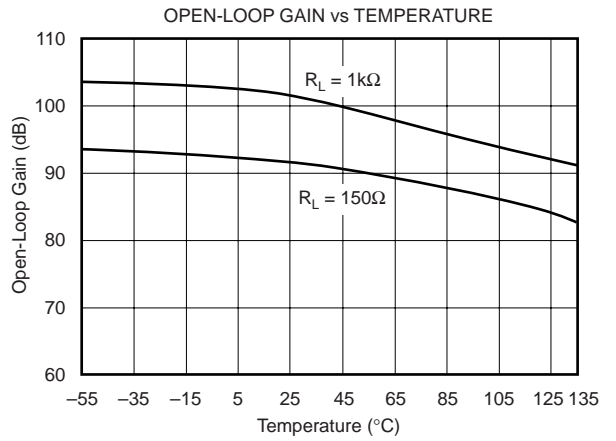
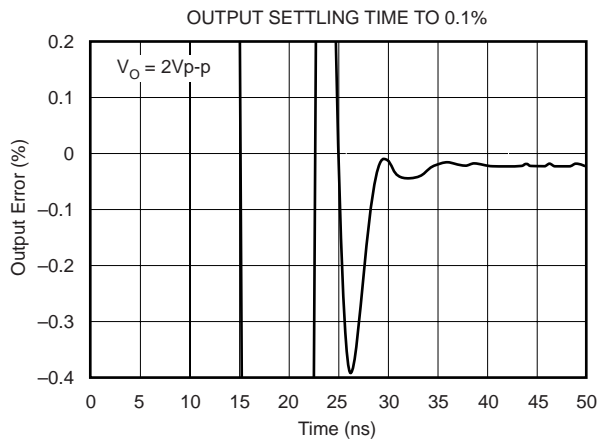
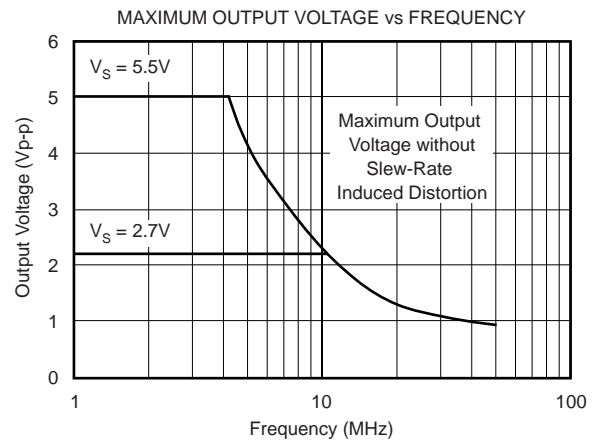
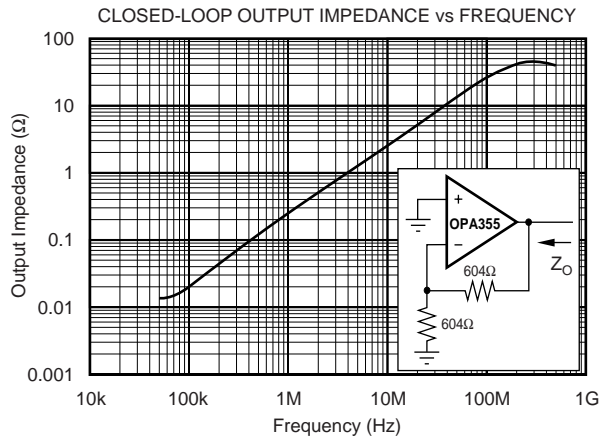

# TYPICAL CHARACTERISTICS (Cont.)

At  $T_A = +25^\circ\text{C}$ ,  $V_S = 5\text{V}$ ,  $G = +2$ ,  $R_F = 604\Omega$ , and  $R_L = 150\Omega$  connected to  $V_S/2$ , unless otherwise noted.

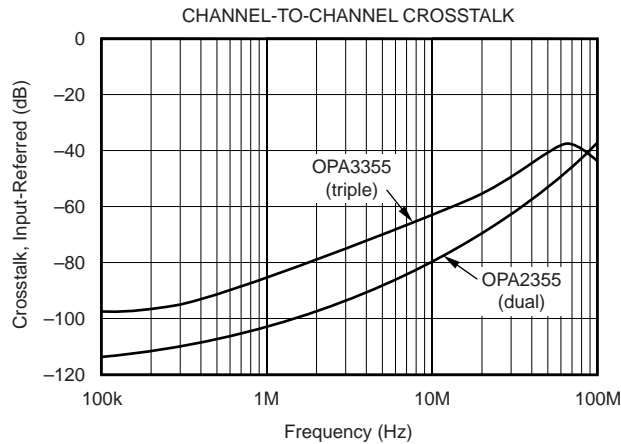

## APPLICATIONS INFORMATION

The OPA355 series is a CMOS, high-speed, voltage-feed-back, operational amplifier designed for video and other general-purpose applications. It is available as a single, dual, or triple op amp.

The amplifier features a 200MHz gain bandwidth and 360V/ $\mu\text{s}$  slew rate, but it is unity-gain stable and can be operated as a +1V/V voltage follower.

Its input common-mode voltage range includes ground, allowing the OPA355 to be used in virtually any single-supply application up to a supply voltage of +5.5V.

### PCB LAYOUT

Good high-frequency PC board layout techniques should be employed for the OPA355. Generous use of ground planes, short direct signal traces, and a suitable bypass capacitor located at the  $V+$  pin will assure clean, stable operation. Large areas of copper also provide a means of dissipating heat that is generated within the amplifier in normal operation.

Sockets are definitely not recommended for use with any high-speed amplifier.

A 10nF ceramic bypass capacitor is the minimum recommended value; adding a 1 $\mu\text{F}$  or larger tantalum capacitor in

parallel can be beneficial when driving a low-resistance load. Providing adequate bypass capacitance is essential to achieving very low harmonic and intermodulation distortion.

### OPERATING VOLTAGE

The OPA355 is specified over a power-supply range of +2.7V to +5.5V ( $\pm 1.35\text{V}$  to  $\pm 2.75\text{V}$ ). However, the supply voltage may range from +2.5V to +5.5V ( $\pm 1.25\text{V}$  to  $\pm 2.75\text{V}$ ). Supply voltages higher than 7.5V (absolute maximum) can permanently damage the amplifier.

Parameters that vary significantly over supply voltage or temperature are shown in the Typical Characteristics section of this data sheet.

### ENABLE FUNCTION

The OPA355 can be enabled by applying a TTL HIGH voltage level to the Enable pin. Conversely, a TTL LOW voltage level will disable the amplifier, reducing its supply current from 8.3mA to only 3.4 $\mu\text{A}$  per amplifier. This pin voltage is referenced to single-supply ground. When using a split-supply, such as  $\pm 2.5\text{V}$ , the enable/disable voltage levels will be referenced to  $V-$ . Independent Enable pins are available for each channel, providing maximum design flexibility. For portable battery-operated applications, this feature can be used to greatly reduce the average current and thereby extend battery life.

The Enable input can be modeled as a CMOS input gate with a 100kΩ pull-up resistor to V+. Left open, the Enable pin will assume a logic HIGH, and the amplifier will be on.

The Enable time is 100ns and the disable time is only 30ns. This allows the OPA355 to be operated as a “gated” amplifier, or to have its output multiplexed onto a common output bus. When disabled, the output assumes a high-impedance state.

## OUTPUT DRIVE

The output stage can supply high short-circuit current (typically over 200mA). Therefore, an on-chip thermal shutdown circuit is provided to protect the OPA355 from dangerously high junction temperatures. At 160°C, the protection circuit will shut down the amplifier. Normal operation will resume when the junction temperature cools to below 140°C.

NOTE: it is not recommended to run a continuous DC current in excess of ±60mA. Refer to the Typical Characteristics, *Output Voltage Swing vs Output Current*.

## VIDEO

The OPA355 output stage is capable of driving a standard back-terminated 75Ω video cable. By back-terminating a transmission line, it does not exhibit a capacitive load to its

driver. A properly back-terminated 75Ω cable does not appear as capacitance; it presents only a 150Ω resistive load to the OPA355 output.

The OPA355 can be used as an amplifier for RGB graphic signals, which have a voltage of zero at the video black level, by offsetting and AC-coupling the signal, as shown in Figure 1.

## WIDEBAND VIDEO MULTIPLEXING

One common application for video speed amplifiers which include an enable pin is to wire multiple amplifier outputs together, then select which one of several possible video inputs to source onto a single line. This simple *Wired-OR Video Multiplexer* can be easily implemented using the OPA357; see Figure 2.

## INPUT AND ESD PROTECTION

All OPA355 pins are static protected with internal ESD protection diodes tied to the supplies; see Figure 3.

These diodes will provide overdrive protection if the current is externally limited to 10mA by the source or by a resistor.

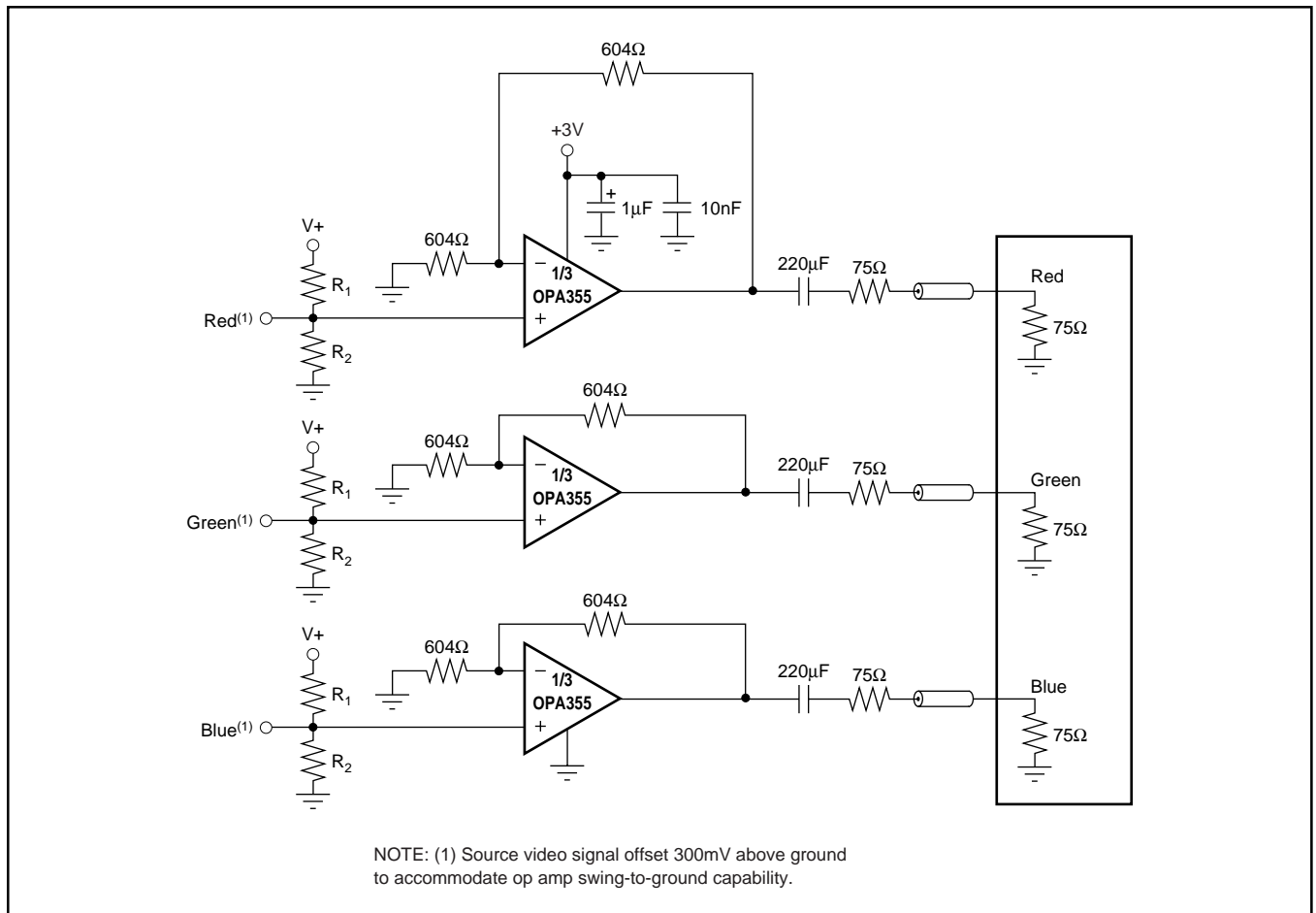

FIGURE 1. RGB Cable Driver.

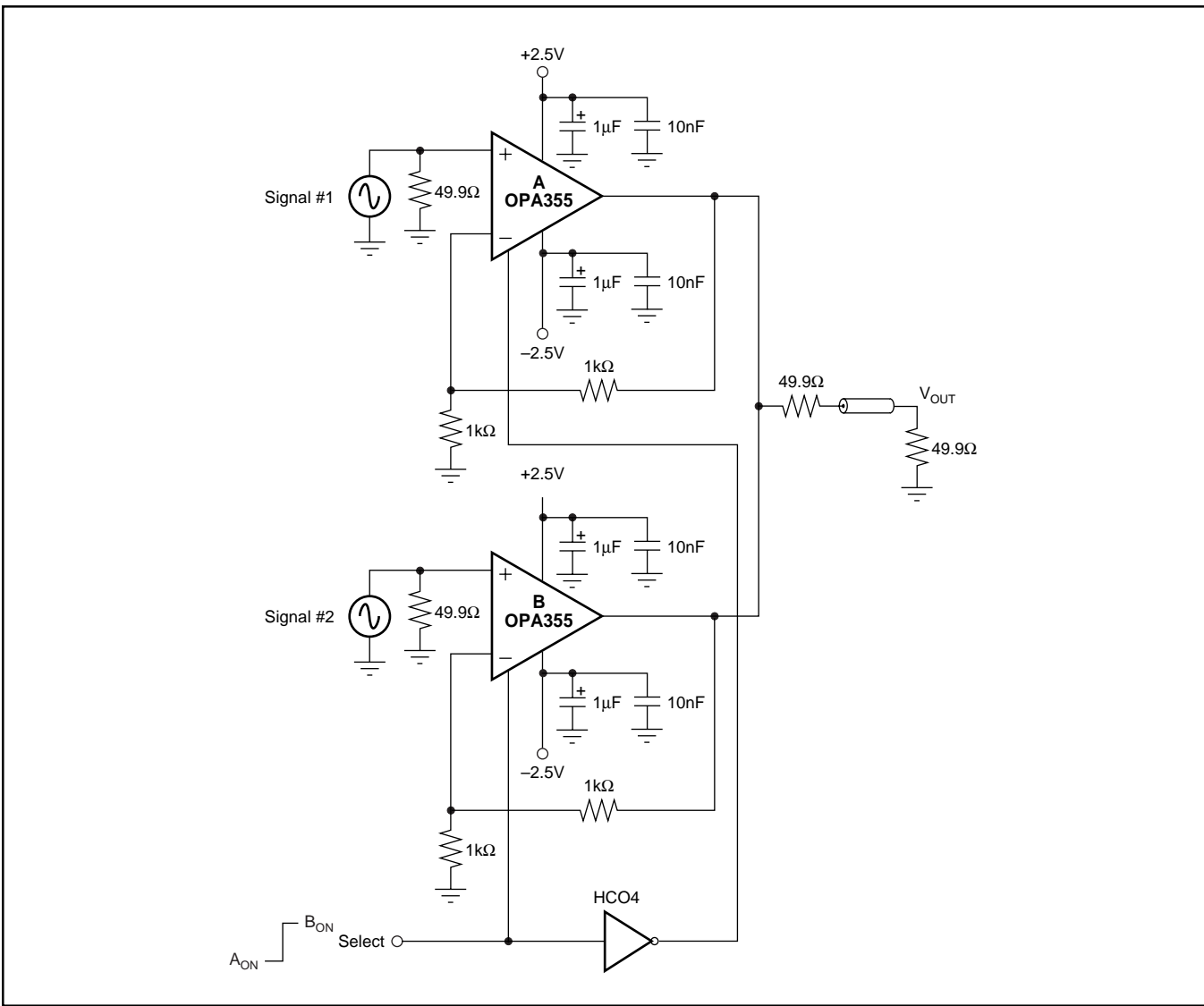

FIGURE 2. Multiplexed Output.

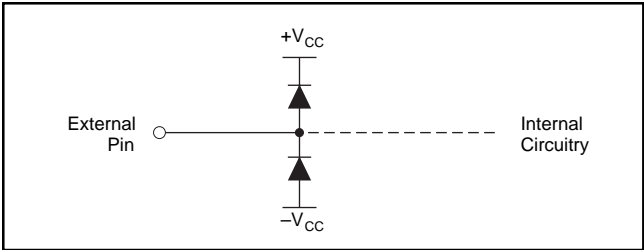

FIGURE 3. Internal ESD Protection.

**PACKAGING INFORMATION**

Orderable Device	Status (1)	Package Type	Package Drawing	Pins	Package Qty	Eco Plan (2)	Lead/Ball Finish	MSL Peak Temp (3)	Samples (Requires Login)
OPA2355DGSA/250	ACTIVE	VSSOP	DGS	10	250	Green (RoHS & no Sb/Br)	CU NIPDAUAG	Level-2-260C-1 YEAR	
OPA2355DGSA/250G4	ACTIVE	VSSOP	DGS	10	250	Green (RoHS & no Sb/Br)	CU NIPDAUAG	Level-2-260C-1 YEAR	
OPA3355EA/250	ACTIVE	TSSOP	PW	14	250	Green (RoHS & no Sb/Br)	CU NIPDAU	Level-2-260C-1 YEAR	
OPA3355EA/250G4	ACTIVE	TSSOP	PW	14	250	Green (RoHS & no Sb/Br)	CU NIPDAU	Level-2-260C-1 YEAR	
OPA3355EA/2K5	ACTIVE	TSSOP	PW	14	2500	Green (RoHS & no Sb/Br)	CU NIPDAU	Level-2-260C-1 YEAR	
OPA3355EA/2K5G4	ACTIVE	TSSOP	PW	14	2500	Green (RoHS & no Sb/Br)	CU NIPDAU	Level-2-260C-1 YEAR	
OPA3355UA	ACTIVE	SOIC	D	14	50	Green (RoHS & no Sb/Br)	CU NIPDAU	Level-2-260C-1 YEAR	
OPA3355UAG4	ACTIVE	SOIC	D	14	50	Green (RoHS & no Sb/Br)	CU NIPDAU	Level-2-260C-1 YEAR	
OPA355NA/250	ACTIVE	SOT-23	DBV	6	250	Green (RoHS & no Sb/Br)	CU NIPDAU	Level-2-260C-1 YEAR	
OPA355NA/250G4	ACTIVE	SOT-23	DBV	6	250	Green (RoHS & no Sb/Br)	CU NIPDAU	Level-2-260C-1 YEAR	
OPA355NA/3K	ACTIVE	SOT-23	DBV	6	3000	Green (RoHS & no Sb/Br)	CU NIPDAU	Level-2-260C-1 YEAR	
OPA355NA/3KG4	ACTIVE	SOT-23	DBV	6	3000	Green (RoHS & no Sb/Br)	CU NIPDAU	Level-2-260C-1 YEAR	
OPA355UA	ACTIVE	SOIC	D	8	75	Green (RoHS & no Sb/Br)	CU NIPDAU	Level-2-260C-1 YEAR	
OPA355UA/2K5	ACTIVE	SOIC	D	8	2500	Green (RoHS & no Sb/Br)	CU NIPDAU	Level-2-260C-1 YEAR	
OPA355UA/2K5G4	ACTIVE	SOIC	D	8	2500	Green (RoHS & no Sb/Br)	CU NIPDAU	Level-2-260C-1 YEAR	
OPA355UAG4	ACTIVE	SOIC	D	8	75	Green (RoHS & no Sb/Br)	CU NIPDAU	Level-2-260C-1 YEAR	

(1) The marketing status values are defined as follows:  
**ACTIVE:** Product device recommended for new designs.

---

**LIFEBUY:** TI has announced that the device will be discontinued, and a lifetime-buy period is in effect.

**NRND:** Not recommended for new designs. Device is in production to support existing customers, but TI does not recommend using this part in a new design.

**PREVIEW:** Device has been announced but is not in production. Samples may or may not be available.

**OBSELETE:** TI has discontinued the production of the device.

<sup>(2)</sup> Eco Plan - The planned eco-friendly classification: Pb-Free (RoHS), Pb-Free (RoHS Exempt), or Green (RoHS & no Sb/Br) - please check <http://www.ti.com/productcontent> for the latest availability information and additional product content details.

**TBD:** The Pb-Free/Green conversion plan has not been defined.

**Pb-Free (RoHS):** TI's terms "Lead-Free" or "Pb-Free" mean semiconductor products that are compatible with the current RoHS requirements for all 6 substances, including the requirement that lead not exceed 0.1% by weight in homogeneous materials. Where designed to be soldered at high temperatures, TI Pb-Free products are suitable for use in specified lead-free processes.

**Pb-Free (RoHS Exempt):** This component has a RoHS exemption for either 1) lead-based flip-chip solder bumps used between the die and package, or 2) lead-based die adhesive used between the die and leadframe. The component is otherwise considered Pb-Free (RoHS compatible) as defined above.

**Green (RoHS & no Sb/Br):** TI defines "Green" to mean Pb-Free (RoHS compatible), and free of Bromine (Br) and Antimony (Sb) based flame retardants (Br or Sb do not exceed 0.1% by weight in homogeneous material)

<sup>(3)</sup> MSL, Peak Temp. -- The Moisture Sensitivity Level rating according to the JEDEC industry standard classifications, and peak solder temperature.

**Important Information and Disclaimer:** The information provided on this page represents TI's knowledge and belief as of the date that it is provided. TI bases its knowledge and belief on information provided by third parties, and makes no representation or warranty as to the accuracy of such information. Efforts are underway to better integrate information from third parties. TI has taken and continues to take reasonable steps to provide representative and accurate information but may not have conducted destructive testing or chemical analysis on incoming materials and chemicals. TI and TI suppliers consider certain information to be proprietary, and thus CAS numbers and other limited information may not be available for release.

In no event shall TI's liability arising out of such information exceed the total purchase price of the TI part(s) at issue in this document sold by TI to Customer on an annual basis.

**TAPE AND REEL INFORMATION**

**QUADRANT ASSIGNMENTS FOR PIN 1 ORIENTATION IN TAPE**

\*All dimensions are nominal

Device	Package Type	Package Drawing	Pins	SPQ	Reel Diameter (mm)	Reel Width W1 (mm)	A0 (mm)	B0 (mm)	K0 (mm)	P1 (mm)	W (mm)	Pin1 Quadrant
OPA2355DGSA/250	VSSOP	DGS	10	250	180.0	12.4	5.3	3.4	1.4	8.0	12.0	Q1
OPA3355EA/250	TSSOP	PW	14	250	180.0	12.4	6.9	5.6	1.6	8.0	12.0	Q1
OPA3355EA/2K5	TSSOP	PW	14	2500	330.0	12.4	6.9	5.6	1.6	8.0	12.0	Q1
OPA355UA/2K5	SOIC	D	8	2500	330.0	12.4	6.4	5.2	2.1	8.0	12.0	Q1

**TAPE AND REEL BOX DIMENSIONS**

\*All dimensions are nominal

Device	Package Type	Package Drawing	Pins	SPQ	Length (mm)	Width (mm)	Height (mm)
OPA2355DGSA/250	VSSOP	DGS	10	250	210.0	185.0	35.0
OPA3355EA/250	TSSOP	PW	14	250	210.0	185.0	35.0
OPA3355EA/2K5	TSSOP	PW	14	2500	367.0	367.0	35.0
OPA355UA/2K5	SOIC	D	8	2500	367.0	367.0	35.0



DBV (R-PDSO-G6)

PLASTIC SMALL-OUTLINE PACKAGE



- NOTES:
- A. All linear dimensions are in millimeters.
  - B. This drawing is subject to change without notice.
  - C. Body dimensions do not include mold flash or protrusion. Mold flash and protrusion shall not exceed 0.15 per side.
  - D. Leads 1,2,3 may be wider than leads 4,5,6 for package orientation.
- $\triangle E$  Falls within JEDEC MO-178 Variation AB, except minimum lead width.

DBV (R-PDSO-G6)

PLASTIC SMALL OUTLINE



- NOTES:
- A. All linear dimensions are in millimeters.
  - B. This drawing is subject to change without notice.
  - C. Customers should place a note on the circuit board fabrication drawing not to alter the center solder mask defined pad.
  - D. Publication IPC-7351 is recommended for alternate designs.
  - E. Laser cutting apertures with trapezoidal walls and also rounding corners will offer better paste release. Customers should contact their board assembly site for stencil design recommendations. Example stencil design based on a 50% volumetric metal load solder paste. Refer to IPC-7525 for other stencil recommendations.

DGS (S-PDSO-G10)

PLASTIC SMALL-OUTLINE PACKAGE



- NOTES:
- A. All linear dimensions are in millimeters.
  - B. This drawing is subject to change without notice.
  - C. Body dimensions do not include mold flash or protrusion.
  - D. Falls within JEDEC MO-187 variation BA.

D (R-PDSO-G14)

PLASTIC SMALL OUTLINE



- NOTES:
- A. All linear dimensions are in inches (millimeters).
  - B. This drawing is subject to change without notice.
  - △C Body length does not include mold flash, protrusions, or gate burrs. Mold flash, protrusions, or gate burrs shall not exceed 0.006 (0,15) each side.
  - △D Body width does not include interlead flash. Interlead flash shall not exceed 0.017 (0,43) each side.
  - E. Reference JEDEC MS-012 variation AB.

D (R-PDSO-G14)

PLASTIC SMALL OUTLINE



4211283-3/E 08/12

- NOTES:
- A. All linear dimensions are in millimeters.
  - B. This drawing is subject to change without notice.
  - C. Publication IPC-7351 is recommended for alternate designs.
  - D. Laser cutting apertures with trapezoidal walls and also rounding corners will offer better paste release. Customers should contact their board assembly site for stencil design recommendations. Refer to IPC-7525 for other stencil recommendations.
  - E. Customers should contact their board fabrication site for solder mask tolerances between and around signal pads.

PW (R-PDSO-G14)

PLASTIC SMALL OUTLINE



- NOTES:
- A. All linear dimensions are in millimeters. Dimensioning and tolerancing per ASME Y14.5M-1994.
  - B. This drawing is subject to change without notice.
  - C. Body length does not include mold flash, protrusions, or gate burrs. Mold flash, protrusions, or gate burrs shall not exceed 0,15 each side.
  - D. Body width does not include interlead flash. Interlead flash shall not exceed 0,25 each side.
  - E. Falls within JEDEC MO-153

PW (R-PDSO-G14)

PLASTIC SMALL OUTLINE



- NOTES:
- All linear dimensions are in millimeters.
  - This drawing is subject to change without notice.
  - Publication IPC-7351 is recommended for alternate designs.
  - Laser cutting apertures with trapezoidal walls and also rounding corners will offer better paste release. Customers should contact their board assembly site for stencil design recommendations. Refer to IPC-7525 for other stencil recommendations.
  - Customers should contact their board fabrication site for solder mask tolerances between and around signal pads.

D (R-PDSO-G8)

PLASTIC SMALL OUTLINE



- NOTES:
- A. All linear dimensions are in inches (millimeters).
  - B. This drawing is subject to change without notice.
  - $\triangle C$  Body length does not include mold flash, protrusions, or gate burrs. Mold flash, protrusions, or gate burrs shall not exceed 0.006 (0,15) each side.
  - $\triangle D$  Body width does not include interlead flash. Interlead flash shall not exceed 0.017 (0,43) each side.
  - E. Reference JEDEC MS-012 variation AA.



D (R-PDSO-G8)

PLASTIC SMALL OUTLINE



- NOTES:
- A. All linear dimensions are in millimeters.
  - B. This drawing is subject to change without notice.
  - C. Publication IPC-7351 is recommended for alternate designs.
  - D. Laser cutting apertures with trapezoidal walls and also rounding corners will offer better paste release. Customers should contact their board assembly site for stencil design recommendations. Refer to IPC-7525 for other stencil recommendations.
  - E. Customers should contact their board fabrication site for solder mask tolerances between and around signal pads.

## IMPORTANT NOTICE

Texas Instruments Incorporated and its subsidiaries (TI) reserve the right to make corrections, enhancements, improvements and other changes to its semiconductor products and services per JESD46, latest issue, and to discontinue any product or service per JESD48, latest issue. Buyers should obtain the latest relevant information before placing orders and should verify that such information is current and complete. All semiconductor products (also referred to herein as "components") are sold subject to TI's terms and conditions of sale supplied at the time of order acknowledgment.

TI warrants performance of its components to the specifications applicable at the time of sale, in accordance with the warranty in TI's terms and conditions of sale of semiconductor products. Testing and other quality control techniques are used to the extent TI deems necessary to support this warranty. Except where mandated by applicable law, testing of all parameters of each component is not necessarily performed.

TI assumes no liability for applications assistance or the design of Buyers' products. Buyers are responsible for their products and applications using TI components. To minimize the risks associated with Buyers' products and applications, Buyers should provide adequate design and operating safeguards.

TI does not warrant or represent that any license, either express or implied, is granted under any patent right, copyright, mask work right, or other intellectual property right relating to any combination, machine, or process in which TI components or services are used. Information published by TI regarding third-party products or services does not constitute a license to use such products or services or a warranty or endorsement thereof. Use of such information may require a license from a third party under the patents or other intellectual property of the third party, or a license from TI under the patents or other intellectual property of TI.

Reproduction of significant portions of TI information in TI data books or data sheets is permissible only if reproduction is without alteration and is accompanied by all associated warranties, conditions, limitations, and notices. TI is not responsible or liable for such altered documentation. Information of third parties may be subject to additional restrictions.

Resale of TI components or services with statements different from or beyond the parameters stated by TI for that component or service voids all express and any implied warranties for the associated TI component or service and is an unfair and deceptive business practice. TI is not responsible or liable for any such statements.

Buyer acknowledges and agrees that it is solely responsible for compliance with all legal, regulatory and safety-related requirements concerning its products, and any use of TI components in its applications, notwithstanding any applications-related information or support that may be provided by TI. Buyer represents and agrees that it has all the necessary expertise to create and implement safeguards which anticipate dangerous consequences of failures, monitor failures and their consequences, lessen the likelihood of failures that might cause harm and take appropriate remedial actions. Buyer will fully indemnify TI and its representatives against any damages arising out of the use of any TI components in safety-critical applications.

In some cases, TI components may be promoted specifically to facilitate safety-related applications. With such components, TI's goal is to help enable customers to design and create their own end-product solutions that meet applicable functional safety standards and requirements. Nonetheless, such components are subject to these terms.

No TI components are authorized for use in FDA Class III (or similar life-critical medical equipment) unless authorized officers of the parties have executed a special agreement specifically governing such use.

Only those TI components which TI has specifically designated as military grade or "enhanced plastic" are designed and intended for use in military/aerospace applications or environments. Buyer acknowledges and agrees that any military or aerospace use of TI components which have **not** been so designated is solely at the Buyer's risk, and that Buyer is solely responsible for compliance with all legal and regulatory requirements in connection with such use.

TI has specifically designated certain components as meeting ISO/TS16949 requirements, mainly for automotive use. In any case of use of non-designated products, TI will not be responsible for any failure to meet ISO/TS16949.

### Products

Audio	<a href="http://www.ti.com/audio">www.ti.com/audio</a>
Amplifiers	<a href="http://amplifier.ti.com">amplifier.ti.com</a>
Data Converters	<a href="http://dataconverter.ti.com">dataconverter.ti.com</a>
DLP® Products	<a href="http://www.dlp.com">www.dlp.com</a>
DSP	<a href="http://dsp.ti.com">dsp.ti.com</a>
Clocks and Timers	<a href="http://www.ti.com/clocks">www.ti.com/clocks</a>
Interface	<a href="http://interface.ti.com">interface.ti.com</a>
Logic	<a href="http://logic.ti.com">logic.ti.com</a>
Power Mgmt	<a href="http://power.ti.com">power.ti.com</a>
Microcontrollers	<a href="http://microcontroller.ti.com">microcontroller.ti.com</a>
RFID	<a href="http://www.ti-rfid.com">www.ti-rfid.com</a>
OMAP Applications Processors	<a href="http://www.ti.com/omap">www.ti.com/omap</a>
Wireless Connectivity	<a href="http://www.ti.com/wirelessconnectivity">www.ti.com/wirelessconnectivity</a>

### Applications

Automotive and Transportation	<a href="http://www.ti.com/automotive">www.ti.com/automotive</a>
Communications and Telecom	<a href="http://www.ti.com/communications">www.ti.com/communications</a>
Computers and Peripherals	<a href="http://www.ti.com/computers">www.ti.com/computers</a>
Consumer Electronics	<a href="http://www.ti.com/consumer-apps">www.ti.com/consumer-apps</a>
Energy and Lighting	<a href="http://www.ti.com/energy">www.ti.com/energy</a>
Industrial	<a href="http://www.ti.com/industrial">www.ti.com/industrial</a>
Medical	<a href="http://www.ti.com/medical">www.ti.com/medical</a>
Security	<a href="http://www.ti.com/security">www.ti.com/security</a>
Space, Avionics and Defense	<a href="http://www.ti.com/space-avionics-defense">www.ti.com/space-avionics-defense</a>
Video and Imaging	<a href="http://www.ti.com/video">www.ti.com/video</a>

### TI E2E Community

[e2e.ti.com](http://e2e.ti.com)