

DATA SHEET

ARRAY CHIP RESISTORS

YC/TC
5%, 1%

sizes

YC: 102/104/122/124/162/164/248/324/158T/358L/358T

TC: 122/124/164

RoHS compliant



SCOPE

This specification describes YC (convex, flat) and TC (concave) series chip resistor arrays with lead-free terminations made by thick film process.

APPLICATIONS

- Terminal for SDRAM and DDRAM
- Computer applications: laptop computer, desktop computer
- Consume electronic equipments: PDAs, PNDs
- Mobile phone, telecom...

FEATURES

- AEC-Q200 qualified
- More efficient in pick & place application
- Low assembly costs
- RoHS compliant
- Products with lead free terminations meet RoHS requirements
- Pb-glass contained in electrodes
- Resistor element and glass are exempted by RoHS
- Reducing environmentally hazardous wastes
- High component and equipment reliability
- Saving of PCB space
- None forbidden-materials used in products/production
- Halogen Free Epoxy

ORDERING EXAMPLE

The ordering code of a YC122 convex chip resistor array, value 1,000 Ω with $\pm 5\%$ tolerance, supplied in 7-inch tape reel is: YC122-JR-071KL.

YC158T network, value 100,000 Ω with 5% tolerance, supplied in 7-inch tape reel is: YC158TJR-07100KL

NOTE

1. All our RSMD products meet RoHS compliant. "LFP" of the internal 2D reel label mentions "Lead Free Process"
2. On customized label, "LFP" or specific symbol printed and the optional "L" at the end of GLOBAL PART NUMBER / I2NC can be added (both are on customer request)

ORDERING INFORMATION - GLOBAL PART NUMBER & I2NC

Both part numbers are identified by the series, size, tolerance, packing type, temperature coefficient, taping reel and resistance value.

YAGEO BRAND ordering code

GLOBAL PART NUMBER (PREFERSRED)

YC **XXXX X X X X XX XXXX L/T**
TC (1) (2) (3) (4) (5) (6) (7) (8)

(1) SIZE

YC: 102/104/122/124/162/164/248/324/158T/358L/358T
 TC: 122/124/164

(2) ARRAYS OR NETWORKS

Array YC102/104/122/124/162/164/248/324: -
 Network YC158T/YC358L/YC358T: NA

(3) TOLERANCE

F = $\pm 1\%$ J = $\pm 5\%$ (for Jumper ordering, use code of J)

(4) PACKAGING TYPE

R = Paper taping reel K = Embossed plastic tape reel

(5) TEMPERATURE COEFFICIENT OF RESISTANCE

- = Base on spec

(6) TAPING REEL

07 = 7 inch dia. Reel
 13 = 13 inch dia. Reel

(7) RESISTANCE VALUE

There are 2~4 digits indicated the resistor value. Letter R/K/M is decimal point.
 Detailed resistance rules show in table of "Resistance rule of global part number".

(8) DEFAULT CODE

Letter L is the system default code for ordering only. (Note)
 Letter T is the only default code for YC102.

Resistance rule of global part number	
Resistance code rule	Example
OR	OR = Jumper
XRXX (1 to 9.76 Ω)	IR = 1 Ω IR5 = 1.5 Ω 9R76 = 9.76 Ω
XXRX (10 to 97.6 Ω)	I0R = 10 Ω 97R6 = 97.6 Ω
XXXR (100 to 976 Ω)	100R = 100 Ω
XKXX (1 to 9.76 K Ω)	1K = 1,000 Ω 9K76 = 9760 Ω
XM (1 M Ω)	1M = 1,000,000 Ω

PHYCOMP BRAND ordering codes

Both GLOBAL PART NUMBER (preferred) and I2NC (traditional) codes are acceptable to order Phycomp brand products.

GLOBAL PART NUMBER (PREFERRED)

For detailed information of GLOBAL PART NUMBER and ordering example, please refer to page 2. TC122 series is supplied and ordered by global part number only.

I2NC CODE

TYPE/ 2×0402	2350	XXX XXXXX L				PAPER / PE TAPE ON REEL (units) ⁽²⁾	
	(1)	(2)	(3)	(4)	10,000	50,000	
ARV321	2350	±5%	1 to 1 MΩ		013 11xxx	013 12xxx	
ARV322	2350	±1%	10 to 1 MΩ		013 2xxxx	013 3xxxx	
Jumper	2350	-	0 Ω		013 91001	-	

Last digit of I2NC Resistance decade ⁽³⁾	Last digit
0.01 to 0.0976 Ω	0
0.1 to 0.976 Ω	7
1 to 9.76 Ω	8
10 to 97.6 Ω	9
100 to 976 Ω	1
1 to 9.76 KΩ	2
10 to 97.6 KΩ	3
100 to 976 KΩ	4
1 to 9.76 MΩ	5
10 to 97.6 MΩ	6

- (1) The resistors have a 12-digit ordering code starting with 2350.
- (2) The subsequent 4 or 5 digits indicate the resistor tolerance and packaging.
- (3) The remaining 4 or 3 digits represent the resistance value with the last digit indicating the multiplier as shown in the table of "Last digit of I2NC".
- (4) "L" is optional symbol ^(Note).

Example:

0.02 Ω	=	0200 or 200
0.3 Ω	=	3007 or 307
1 Ω	=	1008 or 108
33 KΩ	=	3303 or 333
10 MΩ	=	1006 or 106

ORDERING EXAMPLE

The ordering code of a ARV321 resistor, value 1,000Ω with ±5% tolerance, supplied in tape of 10,000 units per reel is: 235001311102(L) or YC122-JR-071KL.

NOTE

- 1. All our RSMD products are RoHS compliant. "LFP" of the internal 2D reel label mentions "Lead Free Process"
- 2. On customized label, "LFP" or specific symbol printed and the optional "L" at the end of GLOBAL PART NUMBER / I2NC can be added (both are on customer request)

MARKING

YC102

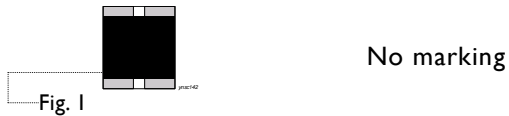

YC122



YC104

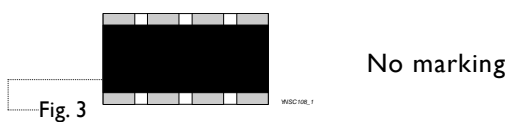

YC124 / 162 / 164 / 324

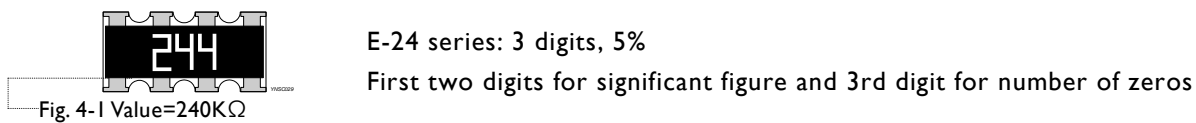
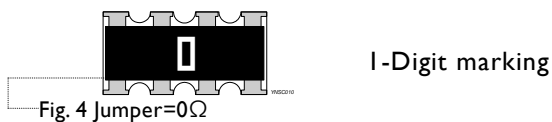

YC248

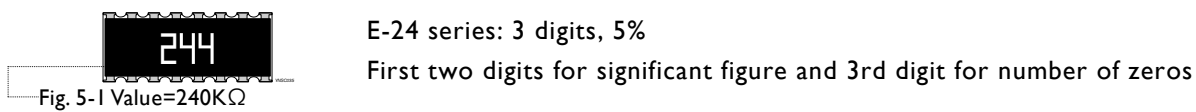
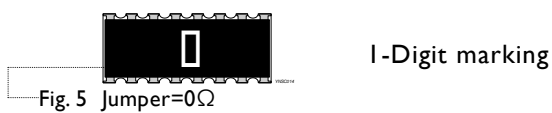

YC158T/358L/358T



TC122



TC124

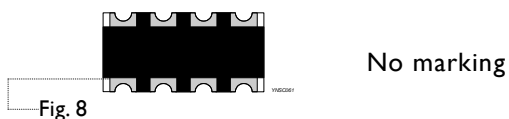

TCI64



I-Digit marking

Fig. 9 Jumper=0Ω



E-24 series: 3 digits, 5%
First two digits for significant figure and 3rd digit for number of zeros

Fig. 9-1 Value=240KΩ

For further marking information, please refer to data sheet “Chip resistors marking”.

CONSTRUCTION

The resistor is constructed on top of a high-grade ceramic body. Internal metal electrodes are added on each end to make the contacts to the thick film resistive element. The composition of the resistive element is a noble metal imbedded into a glass and covered by a second glass to prevent environment influences. The resistor is laser trimmed to the rated resistance value. The resistor is covered with a protective epoxy coat, finally the two external terminations (matte tin on Ni-barrier) are added as shown in Fig.9.

OUTLINES

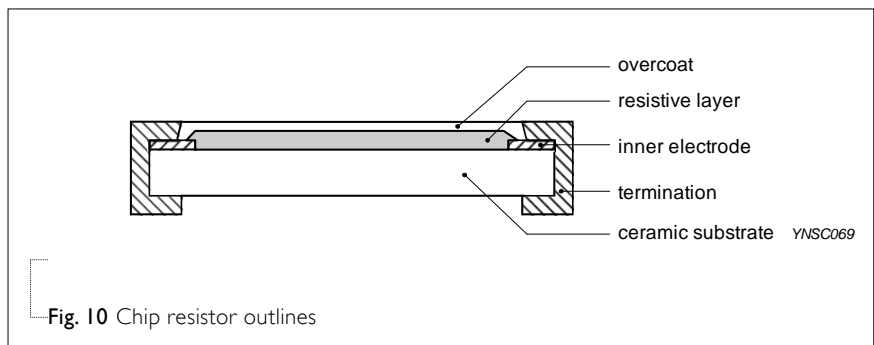

SCHEMATIC



DIMENSIONS

Table I

TYPE	H / H _I / H _W	B	P	L	T	W1	W2
YC102	H: 0.25 ± 0.10	0.15 ± 0.10	0.55 ± 0.10	0.80 ± 0.10	0.35 ± 0.10	0.15 ± 0.10	0.60 ± 0.10
YC104	H: 0.20 ± 0.10	0.15 ± 0.05	0.40 ± 0.10	1.40 ± 0.10	0.35 ± 0.10	0.15 ± 0.10	0.60 ± 0.10
YC122	H: 0.21+0.10 / -0.05 H _W : 0.35 ± 0.10	0.20 ± 0.10	0.67 ± 0.05	1.00 ± 0.10	0.30 ± 0.10	0.25 ± 0.10	1.00 ± 0.10
YC124	H: 0.40 ± 0.15 H _I : 0.30 ± 0.05	0.20 ± 0.15	0.50 ± 0.05	2.00 ± 0.10	0.45 ± 0.10	0.30 ± 0.15	1.00 ± 0.10
YC162	H: 0.30 ± 0.10 H _W : 0.65 ± 0.15	0.30 ± 0.10	0.80 ± 0.05	1.60 ± 0.10	0.40 ± 0.10	0.30 ± 0.10	1.60 ± 0.10
YC164	H: 0.65 ± 0.05 H _I : 0.50 ± 0.15	0.30 ± 0.15	0.80 ± 0.05	3.20 ± 0.15	0.60 ± 0.10	0.30 ± 0.15	1.60 ± 0.15
YC248	H: 0.45 ± 0.05 H _I : 0.30 ± 0.05	0.30 ± 0.15	0.50 ± 0.05	4.00 ± 0.20	0.45 ± 0.10	0.40 ± 0.15	1.60 ± 0.15
YC324	H: 1.10 ± 0.15 H _I : 0.90 ± 0.15	0.50 ± 0.20	1.27 ± 0.05	5.08 ± 0.20	0.60 ± 0.10	0.50 ± 0.15	3.20 ± 0.20
TC122	H: 0.30 ± 0.05	0.25 ± 0.15	0.50 ± 0.05	1.00 ± 0.10	0.30 ± 0.10	0.25 ± 0.15	1.00 ± 0.10
TC124	H: 0.30 ± 0.10	0.20 ± 0.10	0.50 ± 0.05	2.00 ± 0.10	0.40 ± 0.10	0.25 ± 0.10	1.00 ± 0.10
TC164	H: 0.50 ± 0.15	0.30 ± 0.15	0.80 ± 0.05	3.20 ± 0.15	0.60 ± 0.10	0.30 ± 0.15	1.60 ± 0.15
YC158T	H: 0.45 ± 0.05 H _I : 0.32 ± 0.05	0.30 ± 0.15	0.64 ± 0.05	3.20 ± 0.20	0.60 ± 0.10	0.35 ± 0.15	1.60 ± 0.15
YC358L	H: 1.10 ± 0.15	0.50 ± 0.15	1.27 ± 0.05	6.40 ± 0.20	0.60 ± 0.10	0.50 ± 0.15	3.20 ± 0.20
YC358T	H _I : 0.90 ± 0.15						

ELECTRICAL CHARACTERISTICS

Table 2

TYPE	POWER P ₇₀	OPERATING TEMP. RANGE	MWV	RCOV	DWV	RESISTANCE RANGE & TOLERANCE	T. C. R.	Jumper criteria (unit: A)
YC102	1/32W	-55°C to +125°C	15V	30V	30V	E24 ±5% 10Ω ≤ R ≤ 1MΩ E24/E96 ±1% 10Ω ≤ R ≤ 1MΩ Jumper < 0.05Ω	±200 ppm/°C	Rated current 0.5 Max. current 1.0
YC104	1/32W	-55°C to +125°C	12.5V	25V	25V	E24 ±5% 10Ω ≤ R ≤ 1MΩ E24/E96 ±1% 10Ω ≤ R ≤ 1MΩ Jumper < 0.05Ω		Rated current 0.5 Max. current 1.0
YC122	1/16W	-55°C to +155°C	50V	100V	100V	E24 ±5% 1Ω ≤ R ≤ 1MΩ E24/E96 ±1% 1Ω ≤ R ≤ 1MΩ Jumper < 0.05Ω	1Ω ≤ R ≤ 10Ω ±250 ppm/°C 10Ω ≤ R ≤ 1MΩ ±200 ppm/°C	Rated current 0.5 Max. current 1.0
YC124	1/16W	-55°C to +155°C	25V	50V	100V	E24 ±5% 1Ω ≤ R ≤ 1MΩ E24/E96 ±1% 1Ω ≤ R ≤ 1MΩ Jumper < 0.05Ω		Rated current 1.0 Max. current 2.0
YC162	1/16W	-55°C to +155°C	50V	100V	100V	E24 ±5% 1Ω ≤ R ≤ 1MΩ E24/E96 ±1% 1Ω ≤ R ≤ 1MΩ Jumper < 0.05Ω		Rated current 1.0 Max. current 2.0
YC164	1/16W	-55°C to +155°C	50V	100V	100V	E24 ±5% 1Ω ≤ R ≤ 1MΩ E24/E96 ±1% 1Ω ≤ R ≤ 1MΩ Jumper < 0.05Ω		Rated current 1.0 Max. current 2.0
YC248	1/16W	-55°C to +155°C	50V	100V	100V	E24 ±5% 10Ω ≤ R ≤ 1MΩ E24/E96 ±1% 10Ω ≤ R ≤ 1MΩ Jumper < 0.05Ω		Rated current 2.0 Max. current 10.0
YC324	1/8W	-55°C to +155°C	200V	500V	500V	E24 ±5% 10Ω ≤ R ≤ 1MΩ E24/E96 ±1% 10Ω ≤ R ≤ 1MΩ		---
TC122	1/16W	-55°C to +125°C	50V	100V	100V	E24 ±5% 10Ω ≤ R ≤ 1MΩ E24/E96 ±1% 10Ω ≤ R ≤ 1MΩ Jumper < 0.05Ω	±200 ppm/°C	Rated current 1.0 Max. current 1.5
TC124	1/16W	-55°C to +125°C	50V	100V	100V	E24 ±5% 10Ω ≤ R ≤ 1MΩ E24/E96 ±1% 10Ω ≤ R ≤ 1MΩ Jumper < 0.05Ω		Rated current 1.0 Max. current 1.5
TC164	1/16W	-55°C to +155°C	50V	100V	100V	E24 ±5% 10Ω ≤ R ≤ 1MΩ E24/E96 ±1% 10Ω ≤ R ≤ 1MΩ Jumper < 0.05Ω		Rated current 1.0 Max. current 2.0
YC158T	1/16W	-55°C to +155°C	25V	50V	50V	E24 ±5% 10Ω ≤ R ≤ 100KΩ		---
YC358L YC358T	1/16W	-55°C to +155°C	50V	100V	100V	E24 ±5% 10Ω ≤ R ≤ 330KΩ	---	

FOOTPRINT AND SOLDERING PROFILES

For recommended footprint and soldering profiles, please refer to data sheet “Chip resistors mounting”.

PACKING STYLE AND PACKAGING QUANTITY

Table 3 Packing style and packaging quantity

PACKING STYLE	PACKING STYLE	YC102/ 104	YC/TC 122	YC/TC 124	YC162	YC/TC 164	YC248	YC324	YC158T	YC358L YC358T
Paper taping reel (R)	7" (178mm)	10,000	10,000	10,000	5,000	5,000	5,000	---	5,000	---
	13" (254mm)	50,000	50,000	40,000	---	20,000	---	---	20,000	---
Embossed taping reel (K)	7" (178mm)	---	---	---	---	---	4,000	4,000	---	4,000

NOTE

I. For tape and reel specification/dimensions, please refer to data sheet “Chip resistors packing”.

FUNCTIONAL DESCRIPTION

OPERATING TEMPERATURE RANGE

YC102/104, TC122/124 Range:

-55°C to +125°C (Fig.13)

YC122/124/162/164/248/324/158T/358L/358T, TC164

Range:

-55°C to +155°C(Fig.14)

POWER RATING

Each type rated power at 70°C

YC102/104 = 1/32 W

YC122/124/162/164/248/158T/358L/358T = 1/16 W

YC324 = 1/8 W

TC122/124/164 = 1/16 W

RATED VOLTAGE

The DC or AC (rms) continuous working voltage corresponding to the rated power is determined by the following formula:

$$V = \sqrt{P \times R}$$

or max. working voltage whichever is less

Where

V=Continuous rated DC or AC (rms) working voltage (V)

P=Rated power (W)

R=Resistance value (Ω)



TESTS AND REQUIREMENTS
Table 4 Test condition, procedure and requirements

TEST	TEST METHOD	PROCEDURE	REQUIREMENTS
Life/ Operational Life/ Endurance	MIL-STD-202-method 108	1,000 hours at 70±5 °C applied RCWV	±(2%+0.05 Ω)
	IEC 60115-1 4.25.1	1.5 hours on, 0.5 hour off, still air required	<100 mΩ for Jumper
	JIS C 5202-7.10		
High Temperature Exposure/ Endurance at Upper Category Temperature	MIL-STD-202-method 108	1,000 hours at maximum operating	±(1%+0.05 Ω)
	IEC 60115-1 4.25.3	temperature depending on specification, unpowered	<50 mΩ for Jumper
	JIS C 5202-7.11	No direct impingement of forced air to the parts Tolerances: 125±3 °C	
Moisture Resistance	MIL-STD-202-method 106	Each temperature / humidity cycle is defined at	±(2%+0.05 Ω)
	IEC 60115-1 4.24.2	8 hours (method 106F), 3 cycles / 24 hours for 10d with 25 °C / 65 °C 95% R.H, without steps 7a & 7b, unpowered	<100 mΩ for Jumper
		Parts mounted on test-boards, without condensation on parts Measurement at 24±2 hours after test conclusion	
Thermal Shock	MIL-STD-202-method 107	-55/+125 °C	±(1%+0.05 Ω)
		Note: Number of cycles required is 300. Devices mounted	<50 mΩ for Jumper
		Maximum transfer time is 20 seconds. Dwell time is 15 minutes. Air – Air	
Short Time Overload	MIL-R-55342-para 4.7.5	2.5 times RCWV or maximum overload	±(2%+0.05 Ω)
	IEC60115-1 4.13	voltage whichever is less for 5 sec at room temperature	<50 mΩ for Jumper No visible damage
Board Flex/ Bending	IEC60115-1 4.33	Device mounted on PCB test board as described, only 1 board bending required	±(1%+0.05 Ω)
		3 mm bending	<50 mΩ for Jumper
		Bending time: 60±5 seconds Ohmic value checked during bending	No visible damage

TEST	TEST METHOD	PROCEDURE	REQUIREMENTS
Solderability - Wetting	J-STD-002 test	Electrical Test not required Magnification 50X SMD conditions: 1 st step: method B, aging 4 hours at 155 °C dry heat 2 nd step: leadfree solder bath at 245±3 °C Dipping time: 3±0.5 seconds	Well tinned (≥95% covered) No visible damage
	- Leaching	J-STD-002 test	Leadfree solder, 260 °C, 30 seconds immersion time
- Resistance to Soldering Heat	MIL-STD-202-method 210	Condition B, no pre-heat of samples Leadfree solder, 260 °C, 10 seconds immersion time Procedure 2 for SMD: devices fluxed and cleaned with isopropanol	±(1%+0.05 Ω) <50 mΩ for Jumper No visible damage
Biased Humidity	AEC-Q200 Test 7	1,000 hours; 85 °C / 85% RH	± (5.0%+0.05 Ω)
	MIL-STD-202-Method 103	10% of operating power Measurement at 24± 4 hours after test conclusion.	

REVISION HISTORY

REVISION	DATE	CHANGE NOTIFICATION	DESCRIPTION
Version 9	Feb.19, 2019	-	- Update H dimension for YC124
Version 8	Dec. 24, 2018	-	- Update AEC-Q200 qualified
Version 7	Aug. 22, 2017	-	- Correct the typo for YC158T/358L/358T, Marking, "240" is 24ohm
Version 6	Jun. 1, 2017	-	- Update ordering information for networks YC158T/YC358L/YC358T
Version 5	Feb. 14, 2017	-	- Update YC158 and 358 part number to YC158T , YC358L and YC358T
Version 4	Dec. 22, 2016	-	- Delete YC102 default code L type
Version 3	Apr. 29, 2016	-	- Update YC series and TC164 dimension
Version 2	Dec. 11, 2015	-	- Update Operating Temperature
Version 1	Feb. 04, 2015	-	- Update YC102 to flat type
Version 0	Nov. 14, 2014	-	- First issue of this specification

“ Yageo reserves all the rights for revising the content of this datasheet without further notification, as long as the products itself are unchanged. Any product change will be announced by PCN.”