

## Three Phase Bridge + Thyristor

**VRRM / VDRM** 800 to 1800V  
**IFAV / ITAV** 75A

### Features

- Blocking voltage:800 to 1800V
- Three Phase Bridge and a Thyristor
- Isolated Module package

### Applications

- Inverter for AC or DC motor control
- Current stabilized power supply
- Switching power supply
- UL recognized applied for file no. E360040

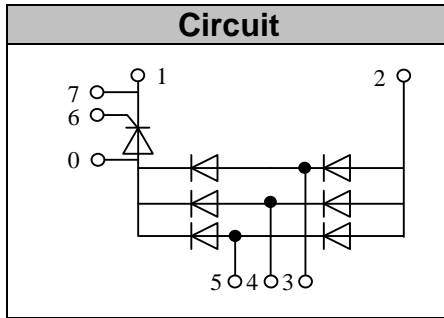

### Module Type

TYPE	VRRM /VDRM	VRSM
MT75DT08L1	800V	900V
MT75DT12L1	1200V	1300V
MT75DT16L1	1600V	1700V
MT75DT18L1	1800V	1900V

### ◆ Diode

#### Maximum Ratings

Symbol	Item	Conditions	Values	Units
ID	Output Current(D.C.)	Tc=101°C Three phase full wave	75	A
IFSM	Surge forward current	t=10mS Tvj =45°C	920	A
i <sup>2</sup> t	Circuit Fusing Consideration		4200	A <sup>2</sup> s
Visol	Isolation Breakdown Voltage(R.M.S)	a.c.50HZ;r.m.s.;1min	3000	V
Tvj	Operating Junction Temperature		-40 to +150	°C
Tstg	Storage Temperature		-40 to +125	°C
Mt	Mounting Torque	To terminals(M5)	3±15%	Nm
Ms		To heatsink(M5)	3±15%	Nm
Weight		Module (Approximately)	210	g

### Thermal Characteristics

Symbol	Item	Conditions	Values	Units
Rth(j-c)	Thermal Impedance, max.	Junction to Case(TOTAL)	0.20	°C/W
Rth(c-s)	Thermal Impedance, max.	Case to Heatsink	0.10	°C/W

### Electrical Characteristics

Symbol	Item	Conditions	Values	Units
VFM	Forward Voltage Drop, max.	T=25°C IF =100A	1.40	V
IRRM	Repetitive Peak Reverse Current, max.	Tvj =25°C VRD=VRRM Tvj =150°C VRD=VRRM	≤0.5 ≤6	mA mA



## ◆ Thyristor Maximum Ratings

Symbol	Item	Conditions	Values	Units
$I_{TAV}$	Average On-State Current	$T_c=99^{\circ}\text{C}$ , Single Phase half wave 180° conduction	75	A
$I_{TSM}$	Surge On-State Current	$T_{VJ}=45^{\circ}\text{C}$ $t=10\text{ms}$ (50Hz), sine $V_R=0$	920	A
$i^2t$	Circuit Fusing Consideration		4200	$\text{A}^2\text{s}$
Visol	Isolation Breakdown Voltage(R.M.S)	a.c.50HZ;r.m.s.;1 min	3000	V
$T_{vj}$	Operating Junction Temperature		-40 to +125	$^{\circ}\text{C}$
$T_{stg}$	Storage Temperature		-40 to +125	$^{\circ}\text{C}$
$M_t$	Mounting Torque	To terminals(M5)	$3\pm 15\%$	Nm
$M_s$		To heatsink(M5)	$3\pm 15\%$	Nm
$di/dt$	Critical Rate of Rise of On-State Current	$T_{VJ}=T_{VJM}$ , $V_D=1/2V_{DRM}$ , $I_G=100\text{mA}$ $d_{iG}/d_t=0.1\text{A}/\mu\text{s}$	150	$\text{A}/\mu\text{s}$
$dv/dt$	Critical Rate of Rise of Off-State Voltage, min.	$T_J=T_{VJM}$ , $V_D=2/3V_{DRM}$ , linear voltage rise	500	$\text{V}/\mu\text{s}$

## Electrical and Thermal Characteristics

Symbol	Item	Conditions	Values			Units
			Min.	Typ.	Max.	
$V_{TM}$	Peak On-State Voltage, max.	$T=25^{\circ}\text{C}$ $I_T=100\text{A}$			1.30	V
$I_{RRM}/I_{DRM}$	Repetitive Peak Reverse Current, max. / Repetitive Peak Off-State Current, max.	$T_{VJ}=T_{VJM}$ , $V_R=V_{RRM}$ , $V_D=V_{DRM}$			20	mA
$V_{GT}$	Gate Trigger Voltage, max.	$T_{VJ}=25^{\circ}\text{C}$ , $V_D=6\text{V}$			3	V
$I_{GT}$	Gate Trigger Current, max.	$T_{VJ}=25^{\circ}\text{C}$ , $V_D=6\text{V}$			150	mA
$R_{th(j-c)}$	Thermal Impedance, max.	Junction to Case			0.30	$^{\circ}\text{C}/\text{W}$
$R_{th(c-s)}$	Thermal Impedance, max.	Case to Heatsink			0.10	$^{\circ}\text{C}/\text{W}$



### Performance Curves

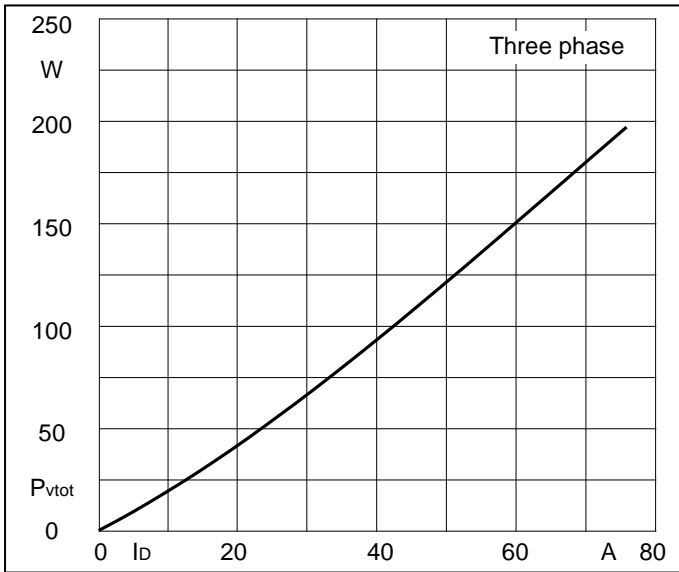

**Fig1. Power dissipation**

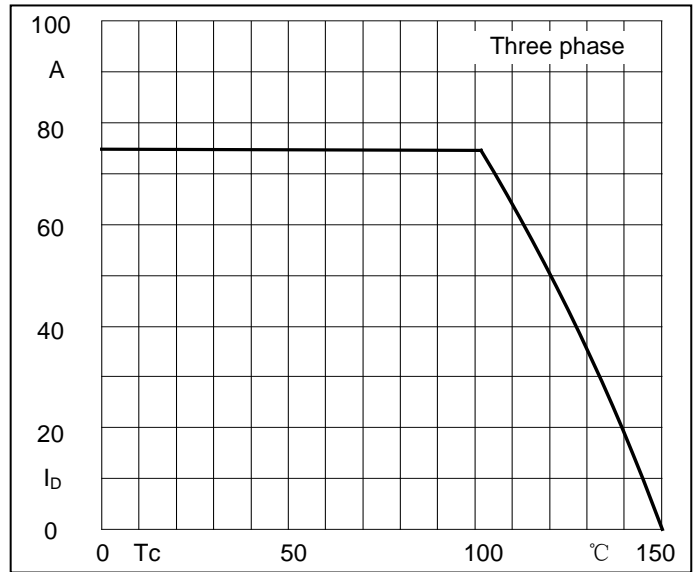

**Fig2. Forward Current Derating Curve**

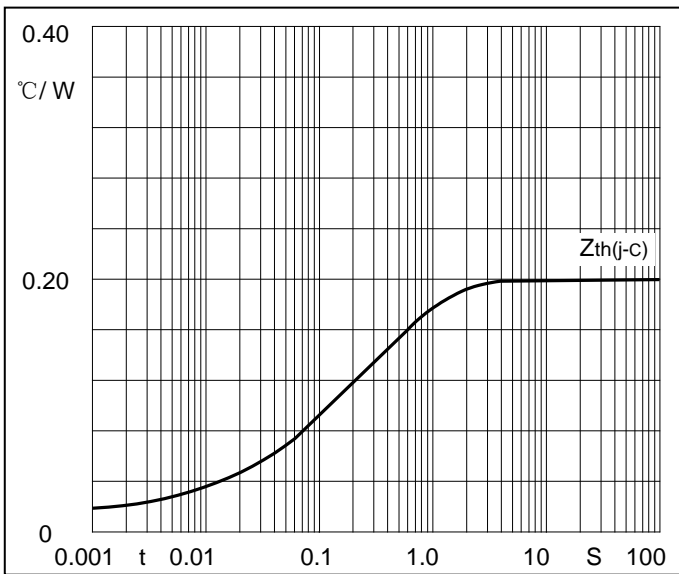

**Fig3. Transient thermal impedance**

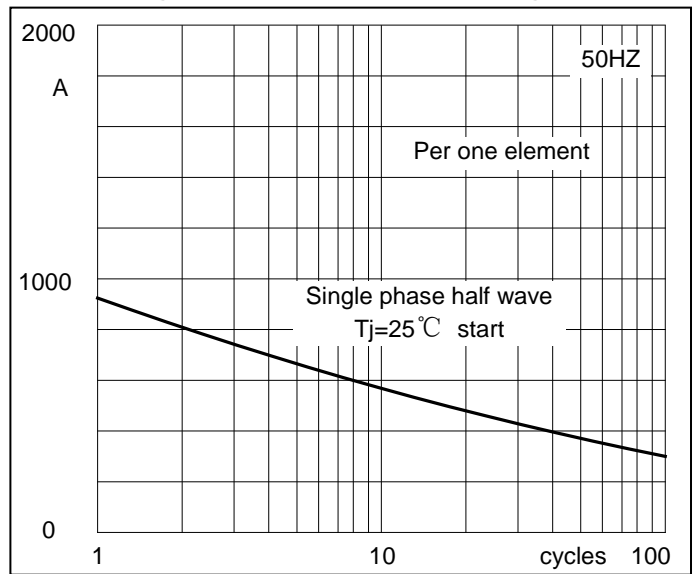

**Fig4. Max Non-Repetitive Forward Surge Current**

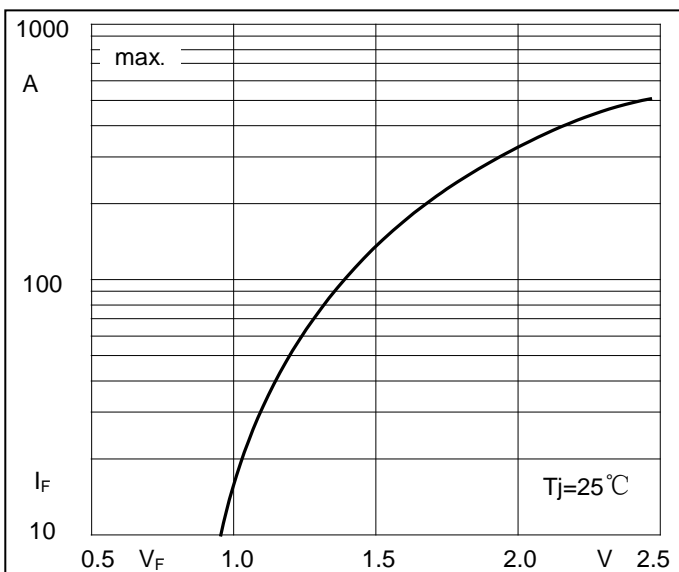

**Fig5. Forward Characteristics**

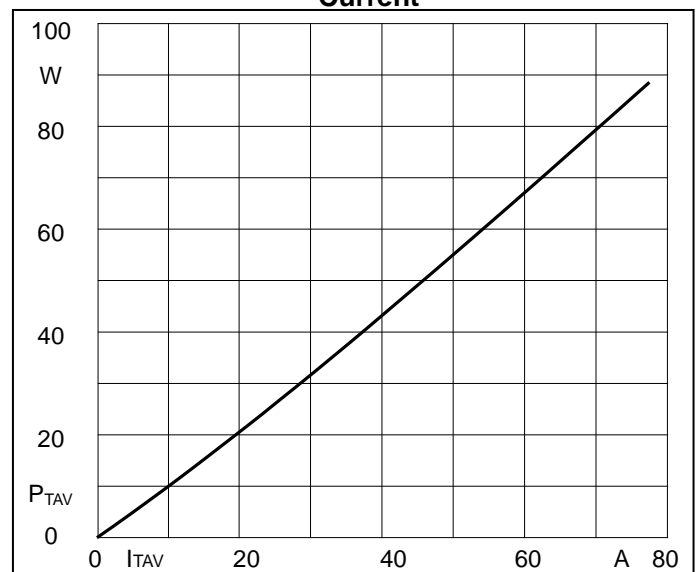

**Fig6. SCR Power dissipation**

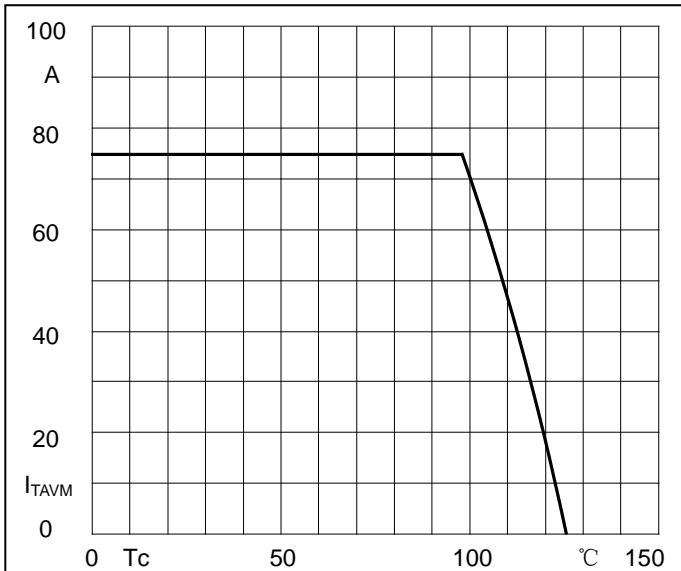

Fig7. SCR Forward Current Derating Curve

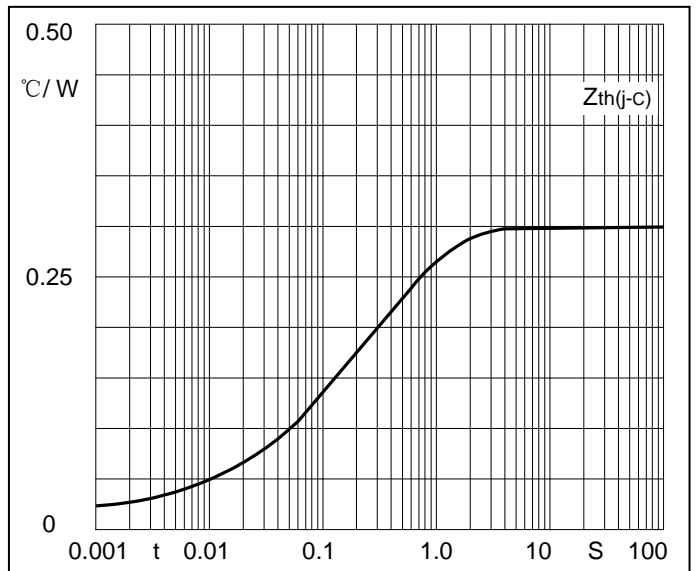

Fig8. SCR Transient thermal impedance

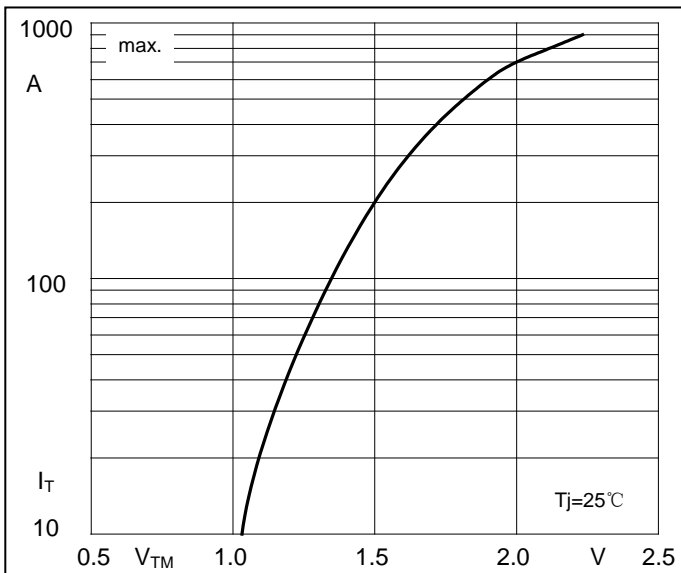

Fig9. SCR Forward Characteristics

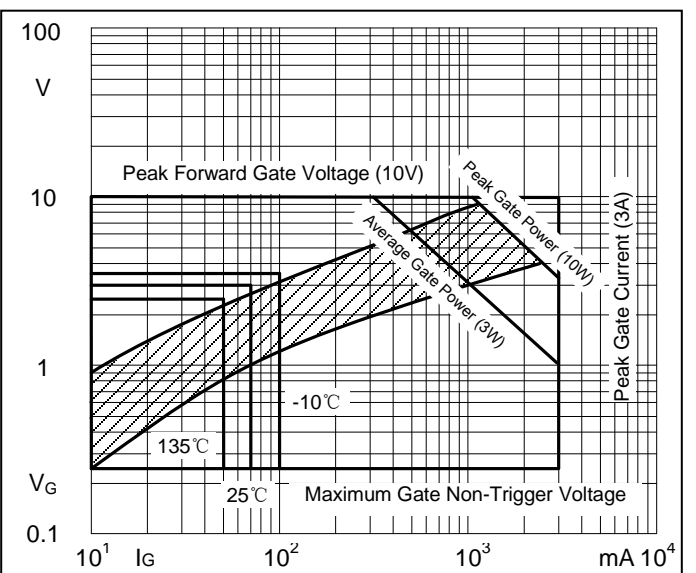

Fig10. Gate trigger Characteristics

## Package Outline Information

