

## Trench MOS Barrier Schottky Rectifier

### SMC-S

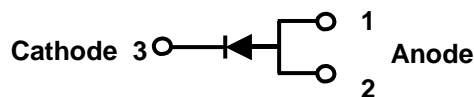
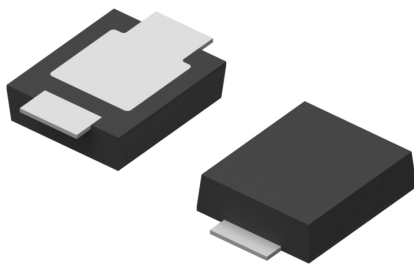

### Features

- Advanced trench technology
- Low forward voltage drop
- Low power losses
- High efficiency operation
- Lead Free Finish, RoHS Compliant

### Applications

- DC/DC Converters
- AC/DC Adaptors

### Maximum ratings and electrical characteristics (T<sub>J</sub> = 25°C unless otherwise noted)

Parameter		Symbol	Limit		Unit
Maximum repetitive peak reverse voltage		V <sub>RRM</sub>	45		V
Maximum average forward rectified current		I <sub>F(AV)</sub>	15		A
Peak forward surge current 8.3 ms single half sine-wave superimposed on rated load per diode		I <sub>FSM</sub>	240		A
Operating junction and storage temperature range		T <sub>J</sub> , T <sub>STG</sub>	-40 to +150		°C
Typical thermal resistance per diode (Mounted on FR-4 PCB)		R <sub>θJL</sub>	15		°C/W
Instantaneous forward voltage	I <sub>F</sub> =2A	T <sub>J</sub> =25°C	TYP.	MAX.	V
			0.34	-	
	I <sub>F</sub> =15A	T <sub>J</sub> =125°C	0.51	0.55	
			0.22	-	
Instantaneous reverse current per diode at rated reverse voltage	T <sub>J</sub> =25°C	I <sub>R(2)</sub>	-	100	uA
			T <sub>J</sub> =125°C	-	50

Notes:

(1) Pulse test: 300 μs pulse width, 1 % duty cycle

(2) Pulse test: Pulse width ≤ 40 ms

## RATINGS AND CHARACTERISTICS CURVES

**RATINGS AND CHARACTERISTICS CURVES** (TA = 25 °C unless otherwise noted)

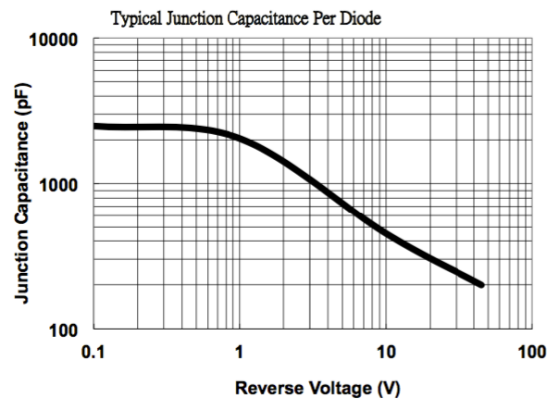
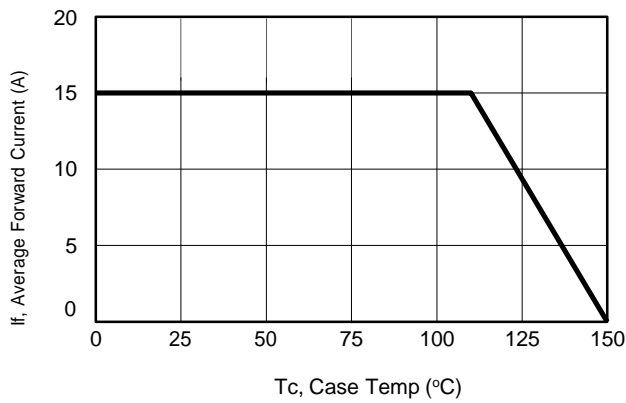
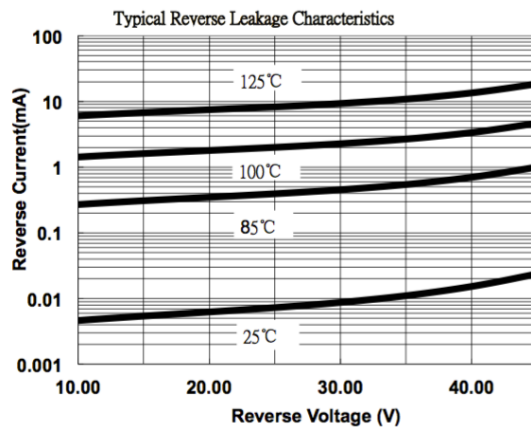
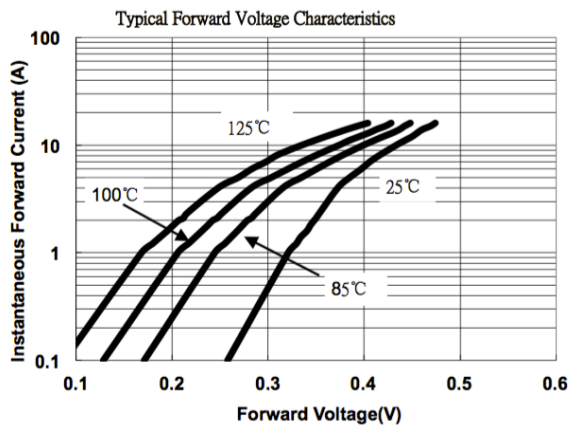

## PACKAGE OUTLINE

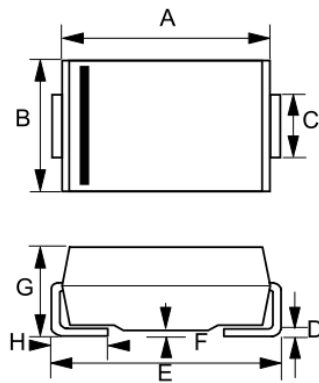

SMC		
DIM.	MIN.	MAX.
A	6.60	7.11
B	5.59	6.22
C	2.92	3.18
D	0.15	0.31
E	7.75	8.13
F	0.05	0.20
G	2.01	2.50
H	0.76	1.52

All Dimensions in millimeter