

TOSHIBA Bipolar Linear Integrated Circuit Silicon Monolithic

## TA78M05F, TA78M06F, TA78M08F, TA78M09F, TA78M10F, TA78M12F, TA78M15F, TA78M18F, TA78M20F, TA78M24F

Output Current of 0.5 A, Three-Terminal Positive Voltage Regulators  
5 V, 6 V, 8 V, 9 V, 10 V, 12 V, 15 V, 18 V, 20 V, 24 V

The TA78M××F series of fixed-voltage monolithic integrated circuit voltage regulators is designed for a wide range of applications. These regulators employ internal current-limiting, thermal-shutdown and safe-area compensation, making them essentially indestructible. One of these regulators can drive up to 0.5 A of output current.

### Features

- Suitable for CMOS, TTL and the power supply of the other digital ICs
- Maximum output current of 0.5 A.
- Internal thermal overload protection.
- Internal short circuit current limiting.
- Packaged in POWER MOLD.

### Pin Assignment

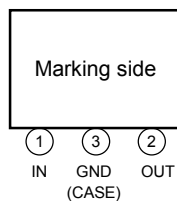

### Marking

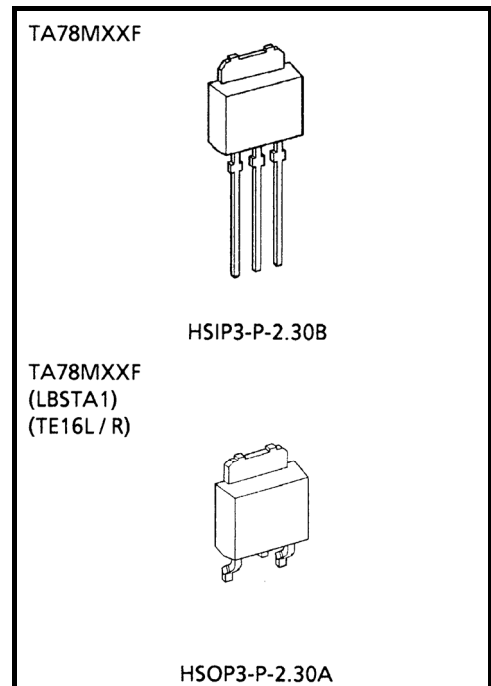
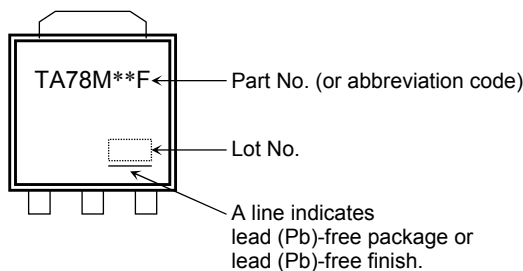

Weight  
HSIP3-P-2.30B: 0.36 g (typ.)  
HSOP3-P-2.30A: 0.36 g (typ.)

## Equivalent Circuit

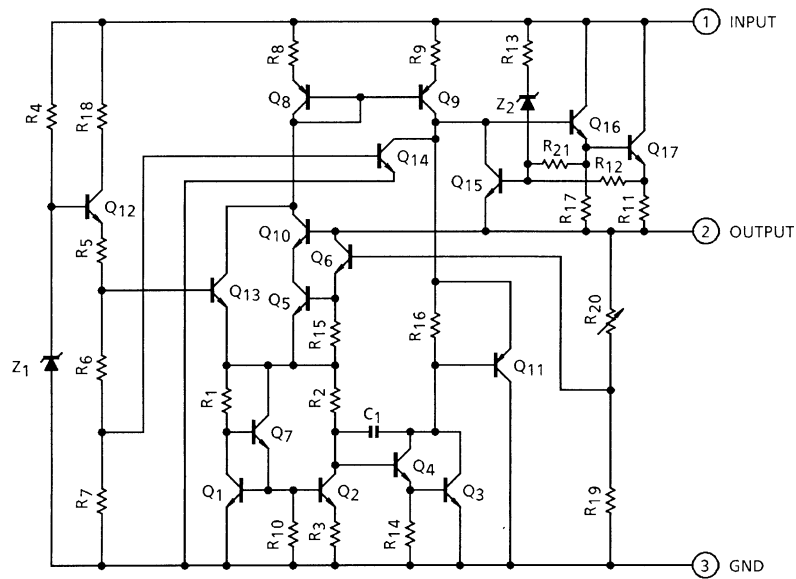

## Absolute Maximum Ratings (Ta = 25°C)

Characteristics		Symbol	Rating	Unit
Input voltage	TA78M05F	V <sub>IN</sub>	35	V
	TA78M06F			
	TA78M08F			
	TA78M09F			
	TA78M10F			
	TA78M12F			
	TA78M15F			
	TA78M18F			
	TA78M20F		40	
	TA78M24F			
Power dissipation	(Ta = 25°C)	P <sub>D</sub>	1	W
	(Tc = 25°C)		10	
Operating temperature		T <sub>opr</sub>	-30~85	°C
Storage temperature		T <sub>stg</sub>	-55~150	°C
Junction temperature		T <sub>j</sub>	150	°C
Thermal resistance			R <sub>th(j-c)</sub>	°C/W
			R <sub>th(j-a)</sub>	

Note: Using continuously under heavy loads (e.g. the application of high temperature/current/voltage and the significant change in temperature, etc.) may cause this product to decrease in the reliability significantly even if the operating conditions (i.e. operating temperature/current/voltage, etc.) are within the absolute maximum ratings and the operating ranges.

Please design the appropriate reliability upon reviewing the Toshiba Semiconductor Reliability Handbook ("Handling Precautions"/Derating Concept and Methods) and individual reliability data (i.e. reliability test report and estimated failure rate, etc).

## TA78M05F

### Electrical Characteristics

(Unless otherwise specified,  $V_{IN} = 10\text{ V}$ ,  $I_{OUT} = 350\text{ mA}$ ,  $0^\circ\text{C} \leq T_j \leq 125^\circ\text{C}$ ,  $C_{IN} = 0.33\ \mu\text{F}$ ,  $C_{OUT} = 0.1\ \mu\text{F}$ )

Characteristics		Symbol	Test Circuit	Test Condition	Min	Typ.	Max	Unit	
Output voltage		$V_{OUT}$	1	$T_j = 25^\circ\text{C}$	4.8	5.0	5.2	V	
Line regulation		Reg-line	1	$T_j = 25^\circ\text{C}$	$7\text{ V} \leq V_{IN} \leq 25\text{ V}$ , $I_{OUT} = 200\text{ mA}$	—	4	100	mV
					$8\text{ V} \leq V_{IN} \leq 25\text{ V}$ , $I_{OUT} = 200\text{ mA}$	—	2	50	
Load regulation		Reg-load	1	$T_j = 25^\circ\text{C}$	$5\text{ mA} \leq I_{OUT} \leq 500\text{ mA}$	—	25	100	mV
					$5\text{ mA} \leq I_{OUT} \leq 200\text{ mA}$	—	10	50	
Output voltage		$V_{OUT}$	1	$T_j = 25^\circ\text{C}$	$7\text{ V} \leq V_{IN} \leq 20\text{ V}$ , $5\text{ mA} \leq I_{OUT} \leq 350\text{ mA}$	4.75	—	5.25	V
Quiescent current		$I_B$	1	$T_j = 25^\circ\text{C}$	—	4.5	8.0	mA	
Quiescent current change		Line	$\Delta I_B$	1	$T_j = 25^\circ\text{C}$	—	—	0.8	mA
		Load	$\Delta I_{BO}$						
Output noise voltage		$V_{NO}$	2	$T_a = 25^\circ\text{C}$ , $10\text{ Hz} \leq f \leq 100\text{ kHz}$	—	50	200	$\mu\text{V}_{\text{rms}}$	
Ripple rejection		R.R.	3	$f = 120\text{ Hz}$ , $I_{OUT} = 100\text{ mA}$ , $8\text{ V} \leq V_{IN} \leq 18\text{ V}$ , $T_j = 25^\circ\text{C}$	60	67	—	dB	
Short circuit current limit		$I_{SC}$	1	$T_j = 25^\circ\text{C}$	—	960	—	mA	
Dropout voltage		$V_D$	1	$T_j = 25^\circ\text{C}$	—	1.7	—	V	
Average temperature coefficient of output voltage		$T_{CVO}$	1	$I_{OUT} = 5\text{ mA}$	—	-0.6	—	$\text{mV}/^\circ\text{C}$	

## TA78M06F

### Electrical Characteristics

(Unless otherwise specified,  $V_{IN} = 11\text{ V}$ ,  $I_{OUT} = 350\text{ mA}$ ,  $0^\circ\text{C} \leq T_j \leq 125^\circ\text{C}$ ,  $C_{IN} = 0.33\text{ }\mu\text{F}$ ,  $C_{OUT} = 0.1\text{ }\mu\text{F}$ )

Characteristics	Symbol	Test Circuit	Test Condition	Min	Typ.	Max	Unit	
Output voltage	$V_{OUT}$	1	$T_j = 25^\circ\text{C}$	5.75	6.0	6.25	V	
Line regulation	Reg-line	1	$T_j = 25^\circ\text{C}$	$8\text{ V} \leq V_{IN} \leq 25\text{ V}$ , $I_{OUT} = 200\text{ mA}$	—	4	100	mV
				$9\text{ V} \leq V_{IN} \leq 25\text{ V}$ , $I_{OUT} = 200\text{ mA}$	—	2	50	
Load regulation	Reg-load	1	$T_j = 25^\circ\text{C}$	$5\text{ mA} \leq I_{OUT} \leq 500\text{ mA}$	—	25	120	mV
				$5\text{ mA} \leq I_{OUT} \leq 200\text{ mA}$	—	10	60	
Output voltage	$V_{OUT}$	1	$T_j = 25^\circ\text{C}$	5.7	—	6.3	V	
Quiescent current	$I_B$	1	$T_j = 25^\circ\text{C}$	—	4.5	8.0	mA	
Quiescent current change	Line	$\Delta I_B$	1	$T_j = 25^\circ\text{C}$	—	—	0.8	mA
	Load	$\Delta I_{BO}$						
Output noise voltage	$V_{NO}$	2	$T_a = 25^\circ\text{C}$ , $10\text{ Hz} \leq f \leq 100\text{ kHz}$	—	55	220	$\mu\text{V}_{rms}$	
Ripple rejection	R.R.	3	$f = 120\text{ Hz}$ , $I_{OUT} = 100\text{ mA}$ , $9\text{ V} \leq V_{IN} \leq 19\text{ V}$ , $T_j = 25^\circ\text{C}$	58	65	—	dB	
Short circuit current limit	$I_{SC}$	1	$T_j = 25^\circ\text{C}$	—	960	—	mA	
Dropout voltage	$V_D$	1	$T_j = 25^\circ\text{C}$	—	1.7	—	V	
Average temperature coefficient of output voltage	$T_{CVO}$	1	$I_{OUT} = 5\text{ mA}$	—	-0.7	—	$\text{mV}/^\circ\text{C}$	

## TA78M08F

### Electrical Characteristics

(Unless otherwise specified,  $V_{IN} = 14\text{ V}$ ,  $I_{OUT} = 350\text{ mA}$ ,  $0^\circ\text{C} \leq T_j \leq 125^\circ\text{C}$ ,  $C_{IN} = 0.33\text{ }\mu\text{F}$ ,  $C_{OUT} = 0.1\text{ }\mu\text{F}$ )

Characteristics	Symbol	Test Circuit	Test Condition	Min	Typ.	Max	Unit		
Output voltage	$V_{OUT}$	1	$T_j = 25^\circ\text{C}$	7.7	8.0	8.3	V		
Line regulation	Reg-line	1	$T_j = 25^\circ\text{C}$	$10.5\text{ V} \leq V_{IN} \leq 25\text{ V}$ , $I_{OUT} = 200\text{ mA}$	—	5	100	mV	
				$11\text{ V} \leq V_{IN} \leq 25\text{ V}$ , $I_{OUT} = 200\text{ mA}$	—	3	50		
Load regulation	Reg-load	1	$T_j = 25^\circ\text{C}$	$5\text{ mA} \leq I_{OUT} \leq 500\text{ mA}$	—	26	160	mV	
				$5\text{ mA} \leq I_{OUT} \leq 200\text{ mA}$	—	10	80		
Output voltage	$V_{OUT}$	1	$T_j = 25^\circ\text{C}$	$10.5\text{ V} \leq V_{IN} \leq 23\text{ V}$ , $5\text{ mA} \leq I_{OUT} \leq 350\text{ mA}$	7.6	—	8.4	V	
Quiescent current	$I_B$	1	$T_j = 25^\circ\text{C}$	—	4.6	8.0	mA		
Quiescent current change	Line	$\Delta I_{BI}$	1	$T_j = 25^\circ\text{C}$	$11\text{ V} \leq V_{IN} \leq 25.5\text{ V}$ , $I_{OUT} = 200\text{ mA}$	—	—	0.8	mA
	Load	$\Delta I_{BO}$				1	$5\text{ mA} \leq I_{OUT} \leq 350\text{ mA}$	—	
Output noise voltage	$V_{NO}$	2	$T_a = 25^\circ\text{C}$ , $10\text{ Hz} \leq f \leq 100\text{ kHz}$	—	60	250	$\mu\text{V}_{rms}$		
Ripple rejection	R.R.	3	$f = 120\text{ Hz}$ , $I_{OUT} = 100\text{ mA}$ , $11.5\text{ V} \leq V_{IN} \leq 21.5\text{ V}$ , $T_j = 25^\circ\text{C}$	55	62	—	dB		
Short circuit current limit	$I_{SC}$	1	$T_j = 25^\circ\text{C}$	—	960	—	mA		
Dropout voltage	$V_D$	1	$T_j = 25^\circ\text{C}$	—	1.7	—	V		
Average temperature coefficient of output voltage	$T_{CVO}$	1	$I_{OUT} = 5\text{ mA}$	—	-1.0	—	$\text{mV}/^\circ\text{C}$		

## TA78M09F

### Electrical Characteristics

(Unless otherwise specified,  $V_{IN} = 15\text{ V}$ ,  $I_{OUT} = 350\text{ mA}$ ,  $0^\circ\text{C} \leq T_j \leq 125^\circ\text{C}$ ,  $C_{IN} = 0.33\ \mu\text{F}$ ,  $C_{OUT} = 0.1\ \mu\text{F}$ )

Characteristics		Symbol	Test Circuit	Test Condition	Min	Typ.	Max	Unit	
Output voltage		$V_{OUT}$	1	$T_j = 25^\circ\text{C}$	8.64	9.0	9.36	V	
Line regulation		Reg-line	1	$T_j = 25^\circ\text{C}$	$11.5\text{ V} \leq V_{IN} \leq 26\text{ V}$ , $I_{OUT} = 200\text{ mA}$	—	5	100	mV
					$13\text{ V} \leq V_{IN} \leq 26\text{ V}$ , $I_{OUT} = 200\text{ mA}$	—	3	50	
Load regulation		Reg-load	1	$T_j = 25^\circ\text{C}$	$5\text{ mA} \leq I_{OUT} \leq 500\text{ mA}$	—	26	180	mV
					$5\text{ mA} \leq I_{OUT} \leq 200\text{ mA}$	—	10	90	
Output voltage		$V_{OUT}$	1	$T_j = 25^\circ\text{C}$	$11.5\text{ V} \leq V_{IN} \leq 24\text{ V}$ , $5\text{ mA} \leq I_{OUT} \leq 350\text{ mA}$	8.55	—	9.45	V
Quiescent current		$I_B$	1	$T_j = 25^\circ\text{C}$	—	4.6	8.0	mA	
Quiescent current change		Line	$\Delta I_{BI}$	1	$T_j = 25^\circ\text{C}$	—	—	0.8	mA
		Load	$\Delta I_{BO}$						
Output noise voltage		$V_{NO}$	2	$T_a = 25^\circ\text{C}$ , $10\text{ Hz} \leq f \leq 100\text{ kHz}$	—	60	270	$\mu\text{V}_{\text{rms}}$	
Ripple rejection		R.R.	3	$f = 120\text{ Hz}$ , $I_{OUT} = 100\text{ mA}$ , $12.5\text{ V} \leq V_{IN} \leq 22.5\text{ V}$ , $T_j = 25^\circ\text{C}$	54	61	—	dB	
Short circuit current limit		$I_{SC}$	1	$T_j = 25^\circ\text{C}$	—	960	—	mA	
Dropout voltage		$V_D$	1	$T_j = 25^\circ\text{C}$	—	1.7	—	V	
Average temperature coefficient of output voltage		$T_{CVO}$	1	$I_{OUT} = 5\text{ mA}$	—	-1.1	—	$\text{mV}/^\circ\text{C}$	

## TA78M10F

### Electrical Characteristics

(Unless otherwise specified,  $V_{IN} = 16\text{ V}$ ,  $I_{OUT} = 350\text{ mA}$ ,  $0^\circ\text{C} \leq T_j \leq 125^\circ\text{C}$ ,  $C_{IN} = 0.33\text{ }\mu\text{F}$ ,  $C_{OUT} = 0.1\text{ }\mu\text{F}$ )

Characteristics		Symbol	Test Circuit	Test Condition	Min	Typ.	Max	Unit
Output voltage		$V_{OUT}$	1	$T_j = 25^\circ\text{C}$	9.6	10.0	10.4	V
Line regulation	Reg-line	1	$T_j = 25^\circ\text{C}$	$12.5\text{ V} \leq V_{IN} \leq 26\text{ V}$ , $I_{OUT} = 200\text{ mA}$	—	6	100	mV
				$14\text{ V} \leq V_{IN} \leq 26\text{ V}$ , $I_{OUT} = 200\text{ mA}$	—	3	50	
Load regulation	Reg-load	1	$T_j = 25^\circ\text{C}$	$5\text{ mA} \leq I_{OUT} \leq 500\text{ mA}$	—	26	200	mV
				$5\text{ mA} \leq I_{OUT} \leq 200\text{ mA}$	—	10	100	
Output voltage		$V_{OUT}$	1	$T_j = 25^\circ\text{C}$ $12.5\text{ V} \leq V_{IN} \leq 25\text{ V}$ , $5\text{ mA} \leq I_{OUT} \leq 350\text{ mA}$	9.5	—	10.5	V
Quiescent current		$I_B$	1	$T_j = 25^\circ\text{C}$	—	4.7	8.0	mA
Quiescent current change	Line	$\Delta I_{BI}$	1	$T_j = 25^\circ\text{C}$ $13\text{ V} \leq V_{IN} \leq 26.5\text{ V}$ , $I_{OUT} = 200\text{ mA}$	—	—	0.8	mA
	Load	$\Delta I_{BO}$	1		$5\text{ mA} \leq I_{OUT} \leq 350\text{ mA}$	—	—	
Output noise voltage		$V_{NO}$	2	$T_a = 25^\circ\text{C}$ , $10\text{ Hz} \leq f \leq 100\text{ kHz}$	—	65	280	$\mu\text{V}_{rms}$
Ripple rejection		R.R.	3	$f = 120\text{ Hz}$ , $I_{OUT} = 100\text{ mA}$ , $13.5\text{ V} \leq V_{IN} \leq 23.5\text{ V}$ , $T_j = 25^\circ\text{C}$	52	59	—	dB
Short circuit current limit		$I_{SC}$	1	$T_j = 25^\circ\text{C}$	—	960	—	mA
Dropout voltage		$V_D$	1	$T_j = 25^\circ\text{C}$	—	1.7	—	V
Average temperature coefficient of output voltage		$T_{CVO}$	1	$I_{OUT} = 5\text{ mA}$	—	-1.3	—	$\text{mV}/^\circ\text{C}$

## TA78M12F

### Electrical Characteristics

(Unless otherwise specified,  $V_{IN} = 19\text{ V}$ ,  $I_{OUT} = 350\text{ mA}$ ,  $0^\circ\text{C} \leq T_j \leq 125^\circ\text{C}$ ,  $C_{IN} = 0.33\text{ }\mu\text{F}$ ,  $C_{OUT} = 0.1\text{ }\mu\text{F}$ )

Characteristics	Symbol	Test Circuit	Test Condition	Min	Typ.	Max	Unit		
Output voltage	$V_{OUT}$	1	$T_j = 25^\circ\text{C}$	11.5	12.0	12.5	V		
Line regulation	Reg-line	1	$T_j = 25^\circ\text{C}$	$14.5\text{ V} \leq V_{IN} \leq 30\text{ V}$ , $I_{OUT} = 200\text{ mA}$	—	7	100	mV	
				$16\text{ V} \leq V_{IN} \leq 30\text{ V}$ , $I_{OUT} = 200\text{ mA}$	—	3	50		
Load regulation	Reg-load	1	$T_j = 25^\circ\text{C}$	$5\text{ mA} \leq I_{OUT} \leq 500\text{ mA}$	—	27	240	mV	
				$5\text{ mA} \leq I_{OUT} \leq 200\text{ mA}$	—	10	120		
Output voltage	$V_{OUT}$	1	$T_j = 25^\circ\text{C}$	$14.5\text{ V} \leq V_{IN} \leq 27\text{ V}$ , $5\text{ mA} \leq I_{OUT} \leq 350\text{ mA}$	11.4	—	12.6	V	
Quiescent current	$I_B$	1	$T_j = 25^\circ\text{C}$	—	4.8	8.0	mA		
Quiescent current change	Line	$\Delta I_{BI}$	1	$T_j = 25^\circ\text{C}$	$15\text{ V} \leq V_{IN} \leq 30.5\text{ V}$ , $I_{OUT} = 200\text{ mA}$	—	—	0.8	mA
	Load	$\Delta I_{BO}$				1	$5\text{ mA} \leq I_{OUT} \leq 350\text{ mA}$	—	
Output noise voltage	$V_{NO}$	2	$T_a = 25^\circ\text{C}$ , $10\text{ Hz} \leq f \leq 100\text{ kHz}$	—	70	300	$\mu\text{V}_{rms}$		
Ripple rejection	R.R.	3	$f = 120\text{ Hz}$ , $I_{OUT} = 100\text{ mA}$ , $15\text{ V} \leq V_{IN} \leq 25\text{ V}$ , $T_j = 25^\circ\text{C}$	50	57	—	dB		
Short circuit current limit	$I_{SC}$	1	$T_j = 25^\circ\text{C}$	—	960	—	mA		
Dropout voltage	$V_D$	1	$T_j = 25^\circ\text{C}$	—	1.7	—	V		
Average temperature coefficient of output voltage	$T_{CVO}$	1	$I_{OUT} = 5\text{ mA}$	—	-1.6	—	$\text{mV}/^\circ\text{C}$		



## TA78M15F

### Electrical Characteristics

(Unless otherwise specified,  $V_{IN} = 23\text{ V}$ ,  $I_{OUT} = 350\text{ mA}$ ,  $0^\circ\text{C} \leq T_j \leq 125^\circ\text{C}$ ,  $C_{IN} = 0.33\text{ }\mu\text{F}$ ,  $C_{OUT} = 0.1\text{ }\mu\text{F}$ )

Characteristics	Symbol	Test Circuit	Test Condition	Min	Typ.	Max	Unit		
Output voltage	$V_{OUT}$	1	$T_j = 25^\circ\text{C}$	14.4	15.0	15.6	V		
Line regulation	Reg-line	1	$T_j = 25^\circ\text{C}$	$17.5\text{ V} \leq V_{IN} \leq 30\text{ V}$ , $I_{OUT} = 200\text{ mA}$	—	8	100	mV	
				$20\text{ V} \leq V_{IN} \leq 30\text{ V}$ , $I_{OUT} = 200\text{ mA}$	—	4	50		
Load regulation	Reg-load	1	$T_j = 25^\circ\text{C}$	$5\text{ mA} \leq I_{OUT} \leq 500\text{ mA}$	—	27	300	mV	
				$5\text{ mA} \leq I_{OUT} \leq 200\text{ mA}$	—	10	150		
Output voltage	$V_{OUT}$	1	$T_j = 25^\circ\text{C}$	$17.5\text{ V} \leq V_{IN} \leq 30\text{ V}$ , $5\text{ mA} \leq I_{OUT} \leq 350\text{ mA}$	14.25	—	15.75	V	
Quiescent current	$I_B$	1	$T_j = 25^\circ\text{C}$	—	4.8	8.0	mA		
Quiescent current change	Line	$\Delta I_{BI}$	1	$T_j = 25^\circ\text{C}$	$18\text{ V} \leq V_{IN} \leq 30.5\text{ V}$ , $I_{OUT} = 200\text{ mA}$	—	—	0.8	mA
	Load	$\Delta I_{BO}$				1	$5\text{ mA} \leq I_{OUT} \leq 350\text{ mA}$	—	
Output noise voltage	$V_{NO}$	2	$T_a = 25^\circ\text{C}$ , $10\text{ Hz} \leq f \leq 100\text{ kHz}$	—	80	450	$\mu\text{V}_{rms}$		
Ripple rejection	R.R.	3	$f = 120\text{ Hz}$ , $I_{OUT} = 100\text{ mA}$ , $18.5\text{ V} \leq V_{IN} \leq 28.5\text{ V}$ , $T_j = 25^\circ\text{C}$	48	55	—	dB		
Short circuit current limit	$I_{SC}$	1	$T_j = 25^\circ\text{C}$	—	960	—	mA		
Dropout voltage	$V_D$	1	$T_j = 25^\circ\text{C}$	—	1.7	—	V		
Average temperature coefficient of output voltage	$T_{CVO}$	1	$I_{OUT} = 5\text{ mA}$	—	-2.0	—	$\text{mV}/^\circ\text{C}$		

## TA78M18F

### Electrical Characteristics

(Unless otherwise specified,  $V_{IN} = 27\text{ V}$ ,  $I_{OUT} = 350\text{ mA}$ ,  $0^\circ\text{C} \leq T_j \leq 125^\circ\text{C}$ ,  $C_{IN} = 0.33\ \mu\text{F}$ ,  $C_{OUT} = 0.1\ \mu\text{F}$ )

Characteristics	Symbol	Test Circuit	Test Condition	Min	Typ.	Max	Unit		
Output voltage	$V_{OUT}$	1	$T_j = 25^\circ\text{C}$	17.3	18.0	18.7	V		
Line regulation	Reg-line	1	$T_j = 25^\circ\text{C}$	$21\text{ V} \leq V_{IN} \leq 33\text{ V}$ , $I_{OUT} = 200\text{ mA}$	—	9	100	mV	
				$24\text{ V} \leq V_{IN} \leq 33\text{ V}$ , $I_{OUT} = 200\text{ mA}$	—	5	50		
Load regulation	Reg-load	1	$T_j = 25^\circ\text{C}$	$5\text{ mA} \leq I_{OUT} \leq 500\text{ mA}$	—	28	360	mV	
				$5\text{ mA} \leq I_{OUT} \leq 200\text{ mA}$	—	10	180		
Output voltage	$V_{OUT}$	1	$T_j = 25^\circ\text{C}$	$21\text{ V} \leq V_{IN} \leq 33\text{ V}$ , $5\text{ mA} \leq I_{OUT} \leq 350\text{ mA}$	17.1	—	18.9	V	
Quiescent current	$I_B$	1	$T_j = 25^\circ\text{C}$	—	4.8	8.0	mA		
Quiescent current change	Line	$\Delta I_{BI}$	1	$T_j = 25^\circ\text{C}$	$21.5\text{ V} \leq V_{IN} \leq 33.5\text{ V}$ , $I_{OUT} = 200\text{ mA}$	—	—	0.8	mA
	Load	$\Delta I_{BO}$				1	$5\text{ mA} \leq I_{OUT} \leq 350\text{ mA}$	—	
Output noise voltage	$V_{NO}$	2	$T_a = 25^\circ\text{C}$ , $10\text{ Hz} \leq f \leq 100\text{ kHz}$	—	90	490	$\mu\text{V}_{\text{rms}}$		
Ripple rejection	R.R.	3	$f = 120\text{ Hz}$ , $I_{OUT} = 100\text{ mA}$ , $22\text{ V} \leq V_{IN} \leq 32\text{ V}$ , $T_j = 25^\circ\text{C}$	46	53	—	dB		
Short circuit current limit	$I_{SC}$	1	$T_j = 25^\circ\text{C}$	—	960	—	mA		
Dropout voltage	$V_D$	1	$T_j = 25^\circ\text{C}$	—	1.7	—	V		
Average temperature coefficient of output voltage	$T_{CVO}$	1	$I_{OUT} = 5\text{ mA}$	—	-2.5	—	$\text{mV}/^\circ\text{C}$		

## TA78M20F

### Electrical Characteristics

(Unless otherwise specified,  $V_{IN} = 29\text{ V}$ ,  $I_{OUT} = 350\text{ mA}$ ,  $0^\circ\text{C} \leq T_j \leq 125^\circ\text{C}$ ,  $C_{IN} = 0.33\ \mu\text{F}$ ,  $C_{OUT} = 0.1\ \mu\text{F}$ )

Characteristics	Symbol	Test Circuit	Test Condition	Min	Typ.	Max	Unit		
Output voltage	$V_{OUT}$	1	$T_j = 25^\circ\text{C}$	19.2	20.0	20.8	V		
Line regulation	Reg-line	1	$T_j = 25^\circ\text{C}$	$23\text{ V} \leq V_{IN} \leq 35\text{ V}$ , $I_{OUT} = 200\text{ mA}$	—	10	100	mV	
				$24\text{ V} \leq V_{IN} \leq 35\text{ V}$ , $I_{OUT} = 200\text{ mA}$	—	6	50		
Load regulation	Reg-load	1	$T_j = 25^\circ\text{C}$	$5\text{ mA} \leq I_{OUT} \leq 500\text{ mA}$	—	28	400	mV	
				$5\text{ mA} \leq I_{OUT} \leq 200\text{ mA}$	—	10	200		
Output voltage	$V_{OUT}$	1	$T_j = 25^\circ\text{C}$	$23\text{ V} \leq V_{IN} \leq 35\text{ V}$ , $5\text{ mA} \leq I_{OUT} \leq 350\text{ mA}$	19.0	—	21.0	V	
Quiescent current	$I_B$	1	$T_j = 25^\circ\text{C}$	—	4.9	8.0	mA		
Quiescent current change	Line	$\Delta I_{BI}$	1	$T_j = 25^\circ\text{C}$	$23.5\text{ V} \leq V_{IN} \leq 35.5\text{ V}$ , $I_{OUT} = 200\text{ mA}$	—	—	0.8	mA
	Load	$\Delta I_{BO}$				1	$5\text{ mA} \leq I_{OUT} \leq 350\text{ mA}$	—	
Output noise voltage	$V_{NO}$	2	$T_a = 25^\circ\text{C}$ , $10\text{ Hz} \leq f \leq 100\text{ kHz}$	—	95	540	$\mu\text{V}_{\text{rms}}$		
Ripple rejection	R.R.	3	$f = 120\text{ Hz}$ , $I_{OUT} = 100\text{ mA}$ , $24\text{ V} \leq V_{IN} \leq 34\text{ V}$ , $T_j = 25^\circ\text{C}$	46	53	—	dB		
Short circuit current limit	$I_{SC}$	1	$T_j = 25^\circ\text{C}$	—	960	—	mA		
Dropout voltage	$V_D$	1	$T_j = 25^\circ\text{C}$	—	1.7	—	V		
Average temperature coefficient of output voltage	$T_{CVO}$	1	$I_{OUT} = 5\text{ mA}$	—	-3.0	—	$\text{mV}/^\circ\text{C}$		

## TA78M24F

### Electrical Characteristics

(Unless otherwise specified,  $V_{IN} = 33\text{ V}$ ,  $I_{OUT} = 350\text{ mA}$ ,  $0^\circ\text{C} \leq T_j \leq 125^\circ\text{C}$ ,  $C_{IN} = 0.33\text{ }\mu\text{F}$ ,  $C_{OUT} = 0.1\text{ }\mu\text{F}$ )

Characteristics	Symbol	Test Circuit	Test Condition	Min	Typ.	Max	Unit		
Output voltage	$V_{OUT}$	1	$T_j = 25^\circ\text{C}$	23.0	24.0	25.0	V		
Line regulation	Reg-line	1	$T_j = 25^\circ\text{C}$	$27\text{ V} \leq V_{IN} \leq 38\text{ V}$ , $I_{OUT} = 200\text{ mA}$	—	12	100	mV	
				$28\text{ V} \leq V_{IN} \leq 38\text{ V}$ , $I_{OUT} = 200\text{ mA}$	—	7	50		
Load regulation	Reg-load	1	$T_j = 25^\circ\text{C}$	$5\text{ mA} \leq I_{OUT} \leq 500\text{ mA}$	—	30	480	mV	
				$5\text{ mA} \leq I_{OUT} \leq 200\text{ mA}$	—	10	240		
Output voltage	$V_{OUT}$	1	$T_j = 25^\circ\text{C}$	$27\text{ V} \leq V_{IN} \leq 38\text{ V}$ , $5\text{ mA} \leq I_{OUT} \leq 350\text{ mA}$	22.8	—	25.2	V	
Quiescent current	$I_B$	1	$T_j = 25^\circ\text{C}$	—	5.0	8.0	mA		
Quiescent current change	Line	$\Delta I_{BI}$	1	$T_j = 25^\circ\text{C}$	$27.5\text{ V} \leq V_{IN} \leq 38.5\text{ V}$ , $I_{OUT} = 200\text{ mA}$	—	—	0.8	mA
	Load	$\Delta I_{BO}$				1	$5\text{ mA} \leq I_{OUT} \leq 350\text{ mA}$	—	
Output noise voltage	$V_{NO}$	2	$T_a = 25^\circ\text{C}$ , $10\text{ Hz} \leq f \leq 100\text{ kHz}$	—	115	650	$\mu\text{V}_{\text{rms}}$		
Ripple rejection	R.R.	3	$f = 120\text{ Hz}$ , $I_{OUT} = 100\text{ mA}$ , $28\text{ V} \leq V_{IN} \leq 38\text{ V}$ , $T_j = 25^\circ\text{C}$	46	53	—	dB		
Short circuit current limit	$I_{SC}$	1	$T_j = 25^\circ\text{C}$	—	960	—	mA		
Dropout voltage	$V_D$	1	$T_j = 25^\circ\text{C}$	—	1.7	—	V		
Average temperature coefficient of output voltage	$T_{CVO}$	1	$I_{OUT} = 5\text{ mA}$	—	-3.5	—	$\text{mV}/^\circ\text{C}$		

## Test Circuit 1/Standard Application

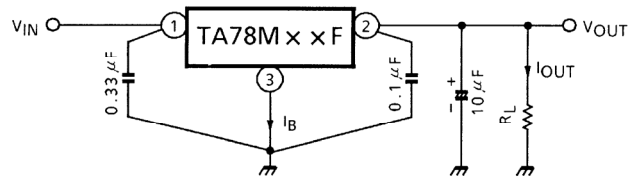

## Test Circuit 2

$V_{NO}$

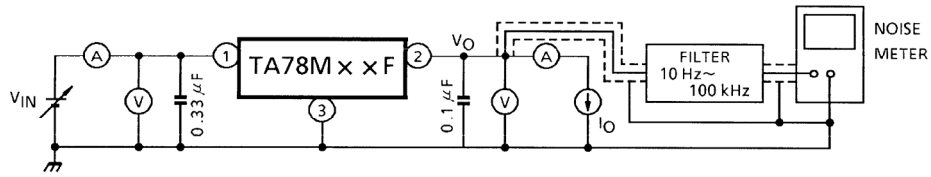

## Test Circuit 3

R.R.

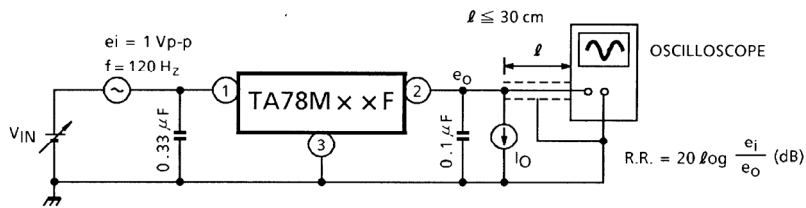

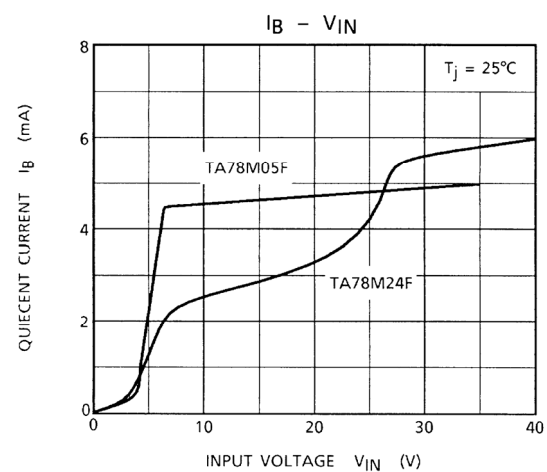
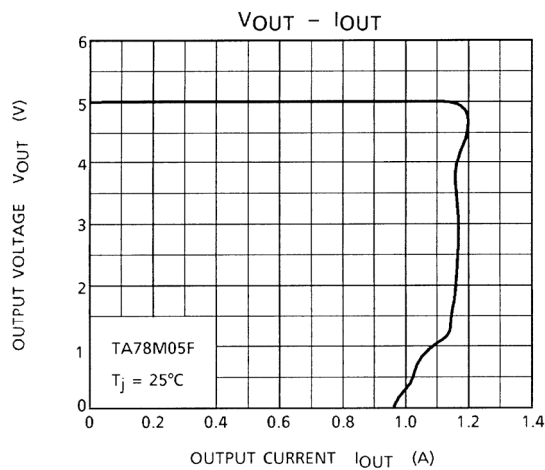
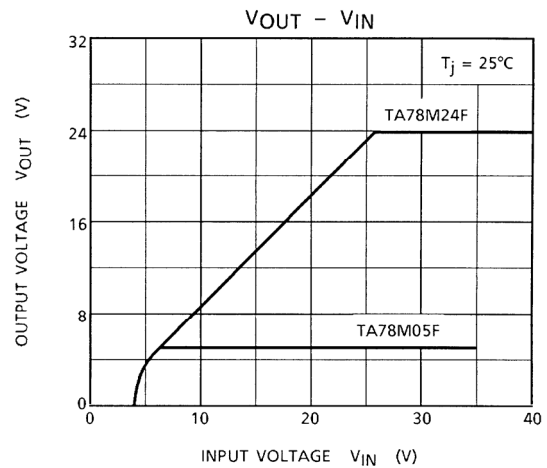
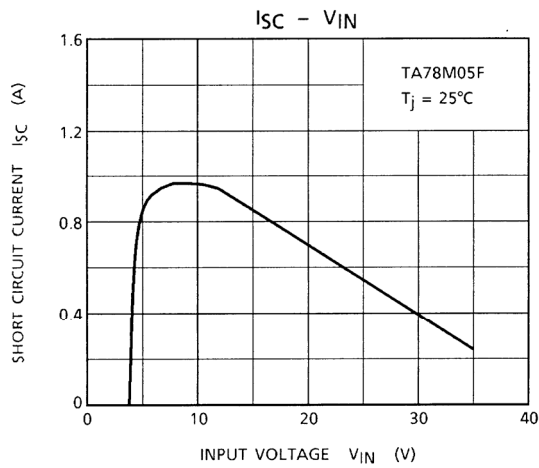
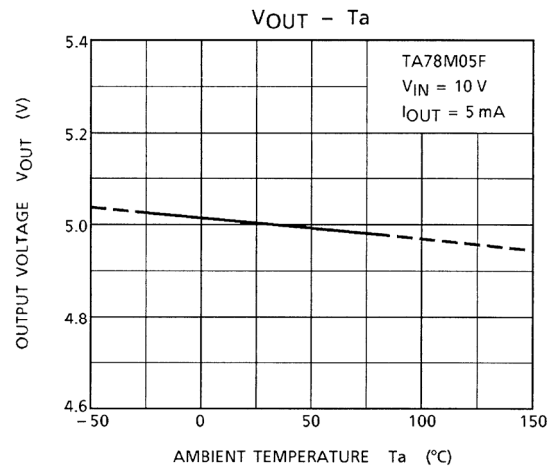
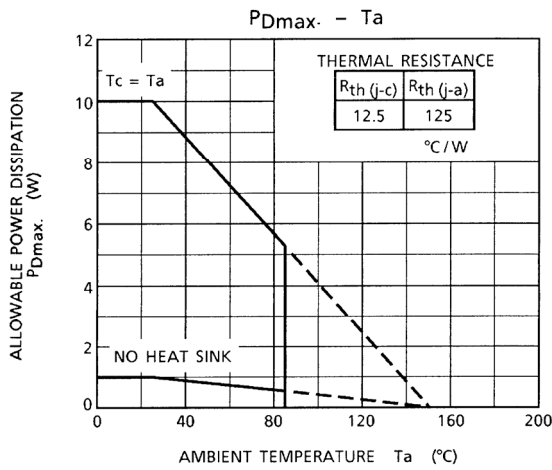

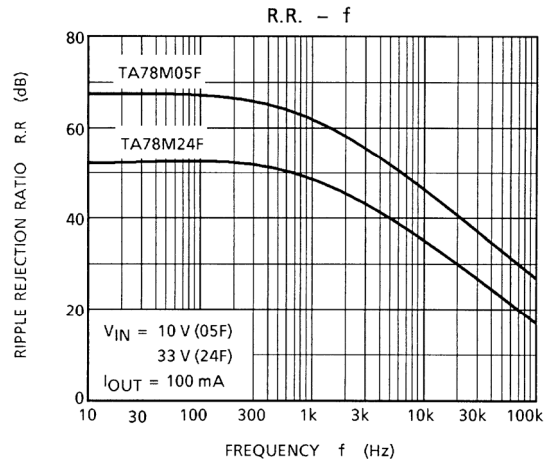
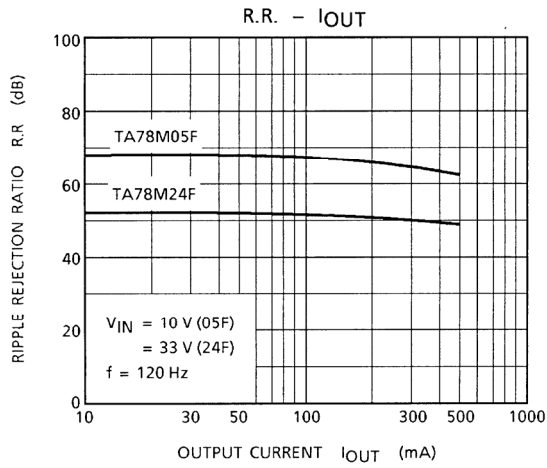
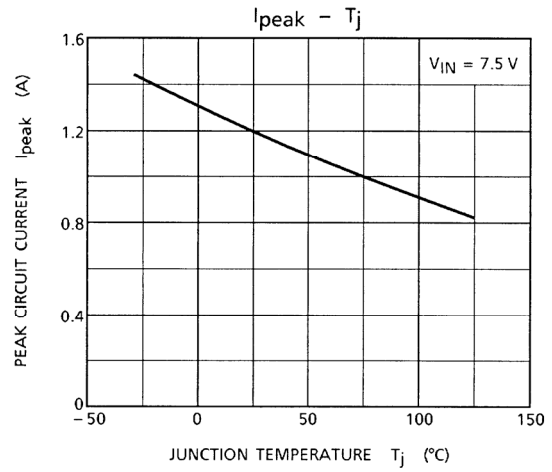
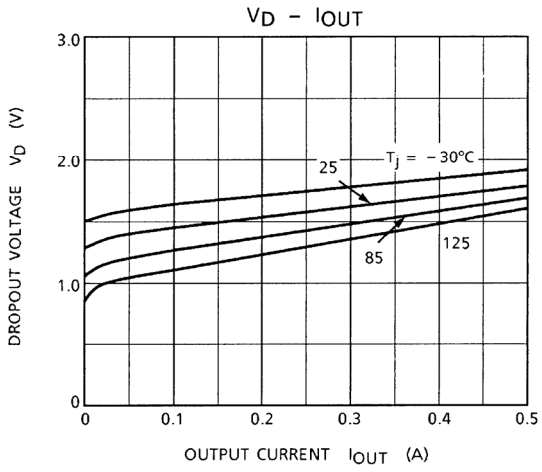

**Precautions on Application**

- (1) In regard to GND, be careful not to apply a negative voltage to the input/output terminal. Further, special care is necessary in the case of a voltage boost application.
- (2) If a surge voltage exceeding the absolute maximum rating is applied to the input terminal or if a voltage in excess of the input terminal voltage is applied to the output terminal, the circuit may be destroyed.  
Particular care is necessary in the case of the latter.

Circuit destruction may also occur if the input terminal shorts to GND in a state of normal operation, causing the output terminal voltage to exceed the input voltage (GND potential) and the electrical charge of the chemical capacitor connected to the output terminal to flow into the input side.

Where these risks exist, take steps such as connecting zener and general silicon diodes to the circuit, as shown in the figure below.

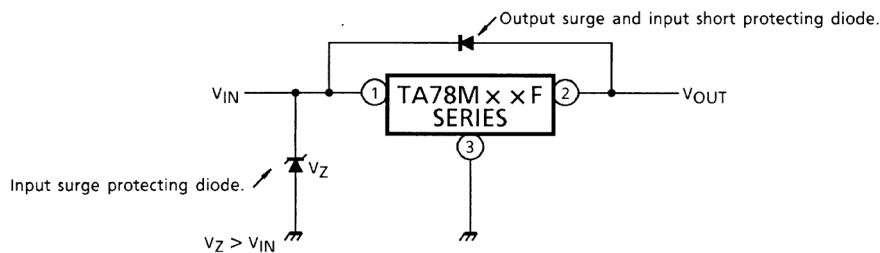

- (3) When the input voltage is too high, the power dissipation of the three-terminal regulator, which is a series regulator, increases, causing the junction temperature to rise. In such a case, it is recommended to reduce the power dissipation, and hence the junction temperature, by inserting a power-limiting resistor R<sub>SD</sub> in the input terminal.

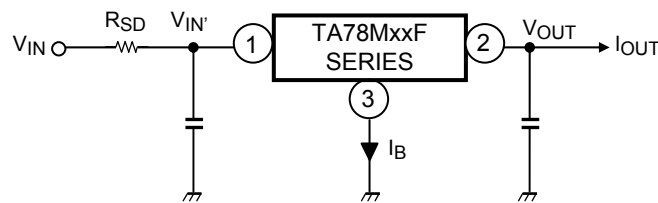

The power dissipation P<sub>D</sub> of the IC is expressed in the following equation.

$$P_D = (V_{IN'} - V_{OUT}) \cdot I_{OUT} + V_{IN'} \cdot I_B$$

Reducing V<sub>IN'</sub> below the lowest voltage necessary for the IC will cause ripple, deterioration in output regulation and, in certain circumstances, parasitic oscillation.

To determine the resistance value of R<sub>SD</sub>, design with a margin, referring to the following equation.

$$R_{SD} < \frac{V_{IN} - V_{IN'}}{I_{OUT} + I_B}$$

- (4) Be sure to connect a capacitor near the input terminal and output terminal between both terminals and GND. The capacitances should be determined experimentally because they depend on printed circuit board patterns. In particular, adequate investigation should be made to ensure there is no problem even in high or low temperatures.



- (5) The molded plastic portion of this unit, measuring 5.5 mm (L) by 6.5 mm (W) by 2.3 mm (T), is more compact compared to its equivalent TO-220.

The collector fin extends directly out of the main body and can be soldered directly to the ceramic circuit board for significant increase in collector power dissipation.

To obtain high reliability on the heat sink design of a regulator IC, it is generally required to derate more than 20% of maximum junction temperature ( $T_j$  max).

Further, full consideration should be given to the installation of the IC on a heat sink.

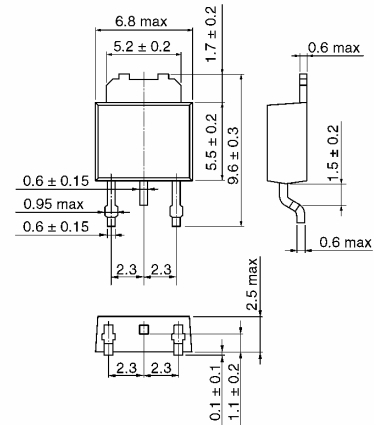

## Application Circuits

### (1) Voltage Boost Regulator

- (a) Voltage boost by use of zener diode

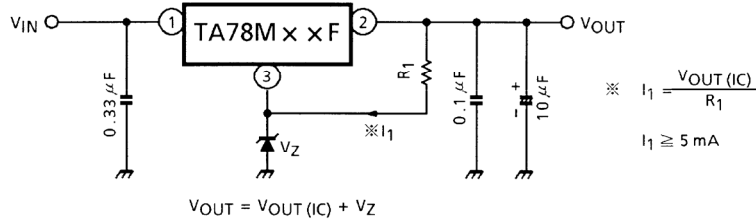

- (b) Voltage boost by use of resistor

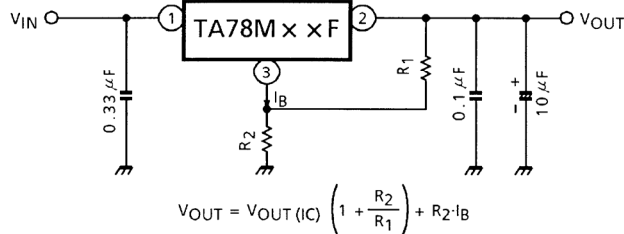

- (c) Adjustable output regulator

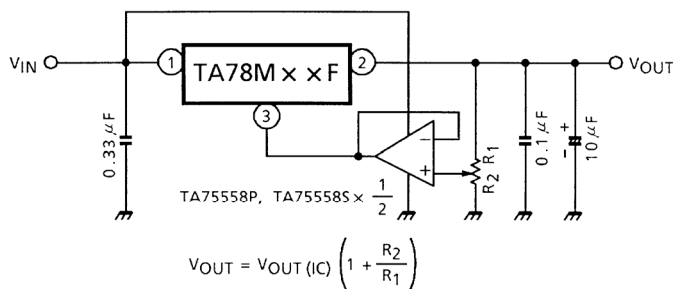

## (2) Current Boost Regulator

(a) Current boost voltage regulator

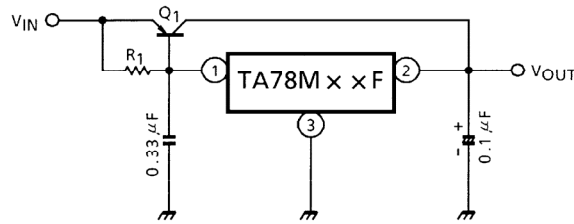

Heat sink is needed for Q1

$$R_1 \cong \frac{V_{BE1}}{I_B \text{ MAX}}$$

where,

$V_{BE1}$  :  $V_{BE}$  of external transistor Q1.

$I_B \text{ MAX}$  : Quiescent current of IC.

(b) Short.circuit protection

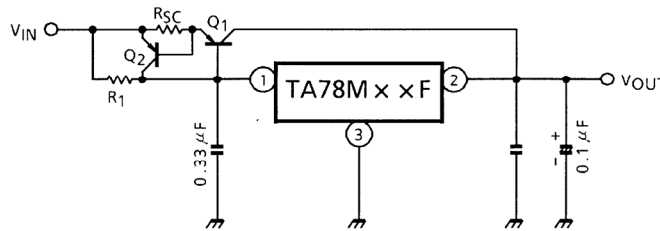

$$R_{SC} = \frac{V_{BE2}}{I_{SC}}$$

where,

$I_{SC}$  : Short-circuit current

## (3) Negative Regulator

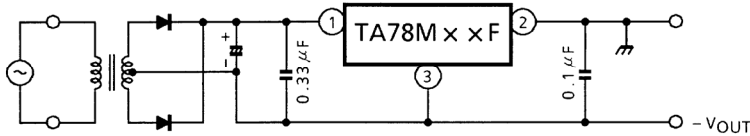

## (4) Positive and Negative Regulator

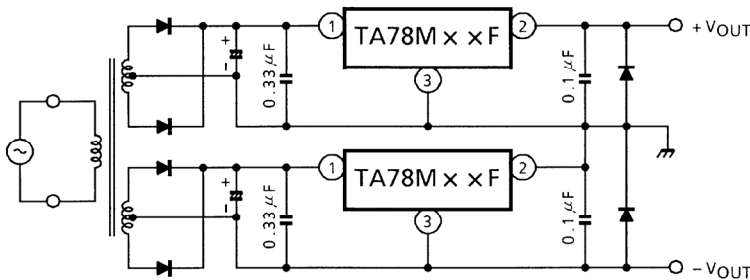

## (5) Current Regulator

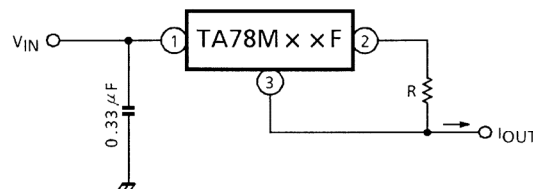

$$I_{OUT} = \frac{V_{OUT}}{R} + I_B$$

## Package Dimensions

HSIP3-P-2.30B

Unit : mm

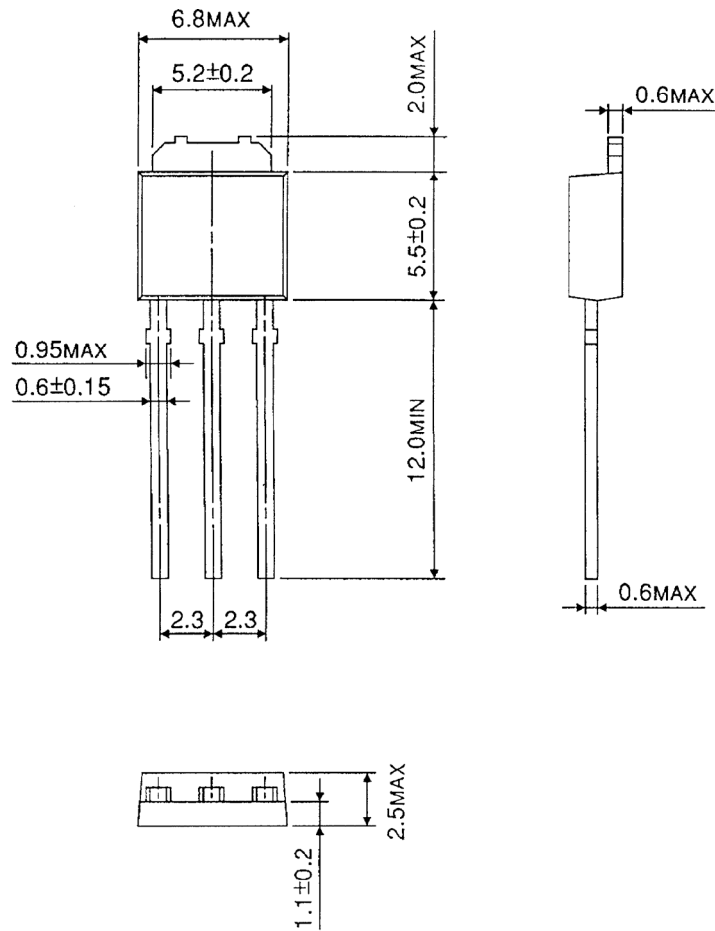

Weight : 0.36 g (Typ.)

## Package Dimensions

HSOP3-P-2.30A

Unit: mm

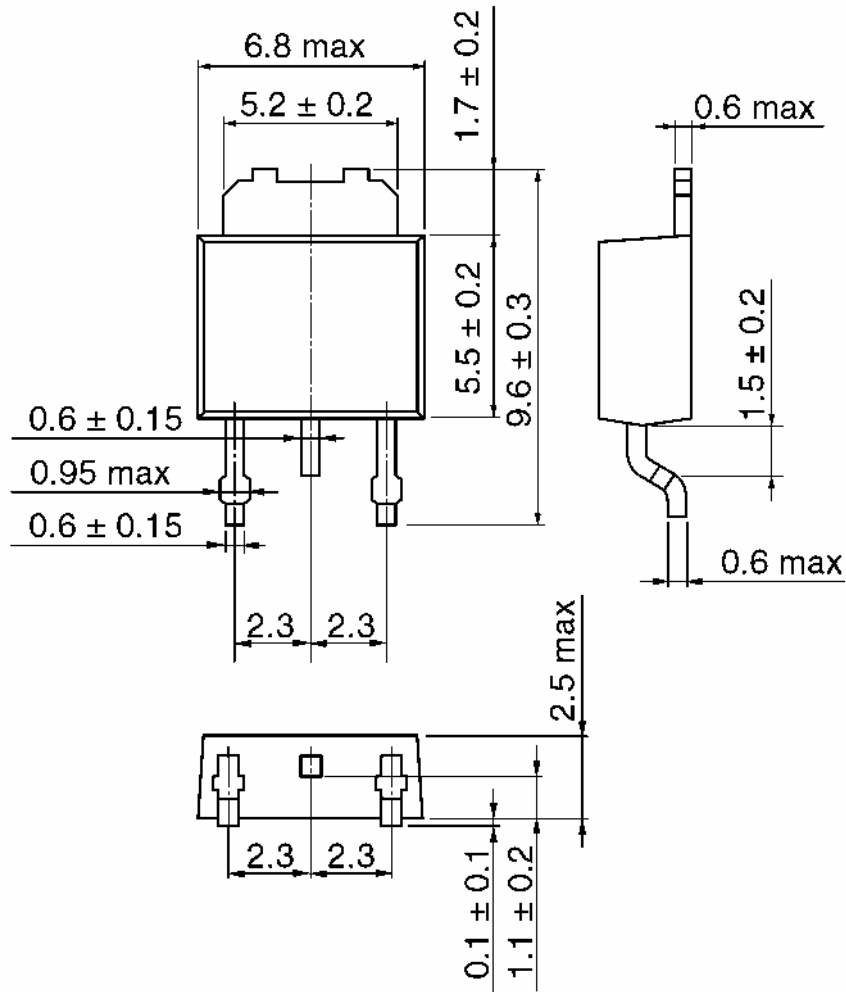

Weight: 0.36 g (typ.)

**RESTRICTIONS ON PRODUCT USE**

20070701-EN

- The information contained herein is subject to change without notice.
- TOSHIBA is continually working to improve the quality and reliability of its products. Nevertheless, semiconductor devices in general can malfunction or fail due to their inherent electrical sensitivity and vulnerability to physical stress. It is the responsibility of the buyer, when utilizing TOSHIBA products, to comply with the standards of safety in making a safe design for the entire system, and to avoid situations in which a malfunction or failure of such TOSHIBA products could cause loss of human life, bodily injury or damage to property.  
In developing your designs, please ensure that TOSHIBA products are used within specified operating ranges as set forth in the most recent TOSHIBA products specifications. Also, please keep in mind the precautions and conditions set forth in the "Handling Guide for Semiconductor Devices," or "TOSHIBA Semiconductor Reliability Handbook" etc.
- The TOSHIBA products listed in this document are intended for usage in general electronics applications (computer, personal equipment, office equipment, measuring equipment, industrial robotics, domestic appliances, etc.). These TOSHIBA products are neither intended nor warranted for usage in equipment that requires extraordinarily high quality and/or reliability or a malfunction or failure of which may cause loss of human life or bodily injury ("Unintended Usage"). Unintended Usage include atomic energy control instruments, airplane or spaceship instruments, transportation instruments, traffic signal instruments, combustion control instruments, medical instruments, all types of safety devices, etc.. Unintended Usage of TOSHIBA products listed in this document shall be made at the customer's own risk.
- The products described in this document shall not be used or embedded to any downstream products of which manufacture, use and/or sale are prohibited under any applicable laws and regulations.
- The information contained herein is presented only as a guide for the applications of our products. No responsibility is assumed by TOSHIBA for any infringements of patents or other rights of the third parties which may result from its use. No license is granted by implication or otherwise under any patents or other rights of TOSHIBA or the third parties.
- Please contact your sales representative for product-by-product details in this document regarding RoHS compatibility. Please use these products in this document in compliance with all applicable laws and regulations that regulate the inclusion or use of controlled substances. Toshiba assumes no liability for damage or losses occurring as a result of noncompliance with applicable laws and regulations.