



VTB18-4P1240V

V18V

PHOTOELECTRIC SENSORS

SICK
Sensor Intelligence.



Ordering information

Type	Part no.
VTB18-4P1240V	6035493

Other models and accessories → www.sick.com/V18V

Illustration may differ



Detailed technical data

Features

Sensor/ detection principle	Photoelectric proximity sensor, Background suppression
Housing design (light emission)	Cylindrical, straight
Housing length	83 mm
Thread diameter (housing)	M18 x 1
Sensing range max.	0 mm ... 140 mm ¹⁾
Sensing range	0 mm ... 130 mm
Type of light	Visible red light
Light source	LED ²⁾
Light spot size (distance)	Ø 15 mm (130 mm)
Wave length	660 nm
Adjustment	Single teach-in button (Sensing range)Manual, via Touch-Teach-in

¹⁾ Object with 90 % reflectance (referred to standard white, DIN 5033).

²⁾ Average service life: 100,000 h at T_U = +25 °C.

Communication interface

Communication interface	-
--------------------------------	---

Mechanics/electronics

Supply voltage	10 V DC ... 30 V DC ¹⁾
Ripple	≤ 10 % ²⁾
Power consumption	≤ 50 mA ³⁾
Output type	PNP
Switching mode	Light/dark switching
Switching mode selector	Selectable via L/D control cable
Signal voltage PNP HIGH/LOW	Approx. $V_S - 2.0 \text{ V} / 0 \text{ V}$
Output current I_{max}	≤ 100 mA
Response time	≤ 0.5 ms ⁴⁾
Switching frequency	1,000 Hz ⁵⁾
Connection type	Male connector M12, 4-pin ⁶⁾
Circuit protection	A ⁷⁾ B ⁸⁾ C ⁹⁾ D ¹⁰⁾
Protection class	III
Weight	120 g
Housing material	Stainless steel, Stainless steel V4A (1.4404, 316L)
Optics material	Plastic, Plan, PPS (Grilamid)
Enclosure rating	IP67, IP68, IP69K ¹¹⁾
Ambient operating temperature	-25 °C ... +80 °C ¹²⁾
Ambient storage temperature	-40 °C ... +80 °C
UL File No.	FDA, UL No. NRKH.E181493 & cUL No. NRKH7.E181493

¹⁾ Limit values.

²⁾ May not exceed or fall below U_V tolerances.

³⁾ Without load, at V_S 30 V DC.

⁴⁾ Signal transit time with resistive load.

⁵⁾ With light/dark ratio 1:1.

⁶⁾ With gold plated contact pins, PPS with FDA certificate.

⁷⁾ A = V_S connections reverse-polarity protected.

⁸⁾ B = interference suppression.

⁹⁾ D = outputs overcurrent and short-circuit protected.

¹⁰⁾ D = inputs and output reverse-polarity protected.

¹¹⁾ With correct mounted IP69K connector.

¹²⁾ +100 °C at max 15 minutes.

Classifications

ECl@ss 5.0	27270904
ECl@ss 5.1.4	27270904
ECl@ss 6.0	27270904
ECl@ss 6.2	27270904
ECl@ss 7.0	27270904
ECl@ss 8.0	27270904
ECl@ss 8.1	27270904

ECl@ss 9.0	27270904
ETIM 5.0	EC002719
ETIM 6.0	EC002719
UNSPSC 16.0901	39121528

Adjustments possible

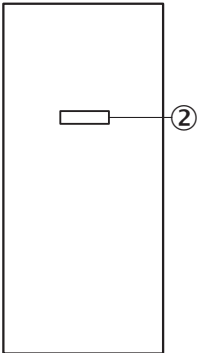

② Sensing range adjustment: Touch-Teach-In

Connection diagram

Cd-087

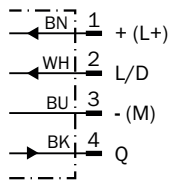

Characteristic curve

VTB18V

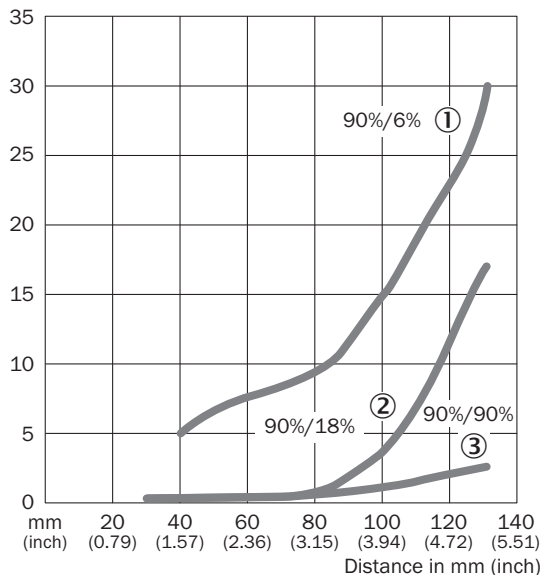

- ① Sensing range on black, 6% remission
- ② Sensing range on gray, 18 % remission
- ③ Sensing range on white, 90% remission

Dimensional drawing (Dimensions in mm (inch))



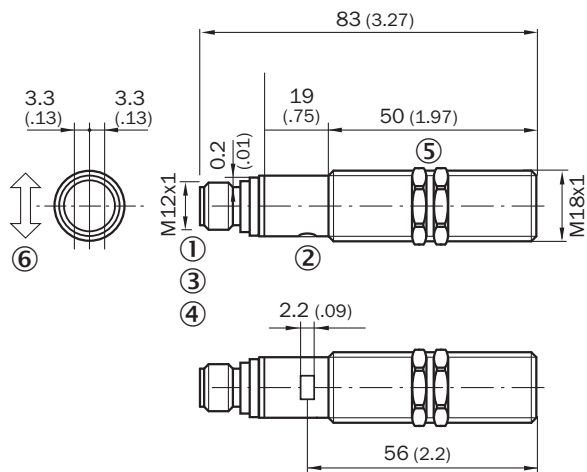



VTB18V



- ① M12 male device connector, 4-pin
- ② Sensing range adjustment: Touch-Teach-In
- ③ Status indicator LED, green: signaling Touch-Teach-in
- ④ LED indicator yellow: Status of received light beam
- ⑤ Fastening nuts (2 x); width across 24, stainless steel
- ⑥ Standard direction of the material being detected

Recommended accessories

Other models and accessories → www.sick.com/V18V

	Brief description	Type	Part no.
Universal bar clamp systems			
	Plate N06N for universal clamp bracket, M18, Stainless steel 1.4571 (sheet), Stainless steel 1.4408 (clamp), Universal clamp (5322627), mounting hardware	BEF-KHS-N06N	2051622
Mounting brackets and plates			
	Mounting plate for M18 sensors, Stainless steel, without mounting hardware	BEF-WG-M18N	5320948
	Mounting bracket for M18 sensors, Stainless steel, without mounting hardware	BEF-WN-M18N	5320947
Terminal and alignment brackets			
	Mounting bracket with ball-and-socket, Plastic, mounting hardware included	BEF-WN-M18-ST02	5312973
	Clamping block for round sensors M18, without fixed stop, plastic (PA12), glass-fiber reinforced, mounting hardware included	BEF-KH-M18	2051481
	Clamping block for round sensors M18, with fixed stop, plastic (PA12), glass-fiber reinforced, mounting hardware included	BEF-KHF-M18	2051482
	Mounting ring, Stainless steel, without mounting hardware	BEF-WN-MH15-2V	4053358

SICK AT A GLANCE

SICK is one of the leading manufacturers of intelligent sensors and sensor solutions for industrial applications. A unique range of products and services creates the perfect basis for controlling processes securely and efficiently, protecting individuals from accidents and preventing damage to the environment.

We have extensive experience in a wide range of industries and understand their processes and requirements. With intelligent sensors, we can deliver exactly what our customers need. In application centers in Europe, Asia and North America, system solutions are tested and optimized in accordance with customer specifications. All this makes us a reliable supplier and development partner.

Comprehensive services complete our offering: SICK LifeTime Services provide support throughout the machine life cycle and ensure safety and productivity.

For us, that is “Sensor Intelligence.”

WORLDWIDE PRESENCE:

Contacts and other locations –www.sick.com