

APD module

C10508-01



Variable gain, stable detection even at high gain

The C10508-01 consists of an APD, current-to-voltage converter, high-voltage power supply circuit as well as a microcontroller for compensating temperature with high stability on the basis of information received from the temperature sensor. The microcontroller contains coefficients according to the temperature characteristics of the APD. This allows highly stable APD gain over a wide temperature range even at high gain. The gain can be adjusted using a switch on the circuit board or commands from a PC.

Features

- **Gain temperature stability: $\pm 5\%$ or less**
(Gain=250, $T_a=0\text{ }^\circ\text{C}$ to $+40\text{ }^\circ\text{C}$)
- **Adjustable gain**
The gain can be adjusted with a switch or commands sent from a PC.
- **Easy handling: Requires only a $\pm 5\text{ V}$ power supply.**
- **Compact and lightweight**

Applications

- **APD evaluation**
- **Optical power meters**
- **Low-light-level detection**

Block diagram

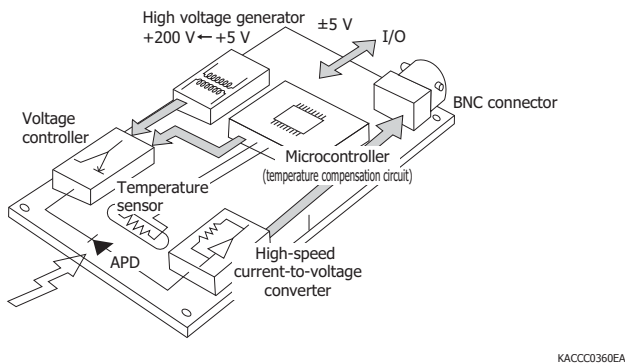

Sensitivity vs. response speed

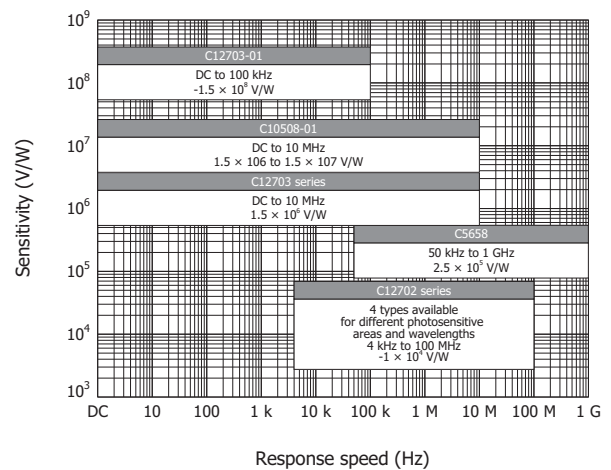

Structure

Parameter	Symbol	Value	Unit
Built-in sensor	-	S12023-10A	-
Photosensitive area	A	$\phi 1.0$	mm
Window material	-	Borosilicate glass	-
Dimensions (W × D × H)	-	60 × 60 × 22	mm
Weight	-	37	g
Interface	-	Conforms to RS-232C	-

Absolute maximum ratings (Ta=25 °C)

Parameter	Symbol	Value	Unit
Positive supply voltage	Vp	+6	V
Negative supply voltage	Vn	-6	V
Maximum incident light level	-	10	mW
Operating temperature*	Topr	0 to +60	°C
Storage temperature*	Tstg	-20 to +70	°C

* No condensation

Note: Exceeding the absolute maximum ratings even momentarily may cause a drop in product quality. Always be sure to use the product within the absolute maximum ratings.

Electrical characteristics

Parameter	Symbol	Condition	Min.	Typ.	Max.	Unit
Supply voltage	Vs	+5V	+4.6	+5.0	+5.4	V
		-5V	-4.6	-5.0	-5.4	V
Current consumption	Ic	+5V	-	+50	+75	mA
		-5V	-	-15	-25	mA
Output impedance	Zo	-	-	50	-	Ω
Feedback resistance	Rf	-	-	10	-	k Ω
Latter-stage amplifier gain	-	-	-	10	-	times
Output polarity	-	-	Positive polarity			-

Electrical and optical characteristics (Typ. Ta=25 °C, unless otherwise noted)

Parameter	Symbol	Condition	Min.	Typ.	Max.	Unit
Spectral response range	λ	-	400 to 1000			nm
Peak sensitivity wavelength	λ_p	-	-	800	-	nm
Photosensitivity	S	M=1, $\lambda=800$ nm	-	0.5	-	A/W
Cutoff frequency	fc	M=10 to 250, -3 dB	8	10	-	MHz
		-	-	DC	-	-
Gain	M	-	Adjustable by switch or serial communication			-
Gain temperature stability	-	M=10 to 250 Ta=0 to 40 °C	-	-	±5	%
Photoelectric conversion sensitivity	-	M=250, $\lambda=800$ nm	1.0×10^7	1.25×10^7	1.5×10^7	V/W
Noise equivalent power	NEP	M=250, $\lambda=800$ nm	-	0.02	0.04	pW/Hz ^{1/2}
Minimum detection limit	-	M=250, $\lambda=800$ nm	-	63	126	pW rms
Saturation incident light level	-	M=250, $\lambda=800$ nm	-	0.24	-	μ W

Spectral response

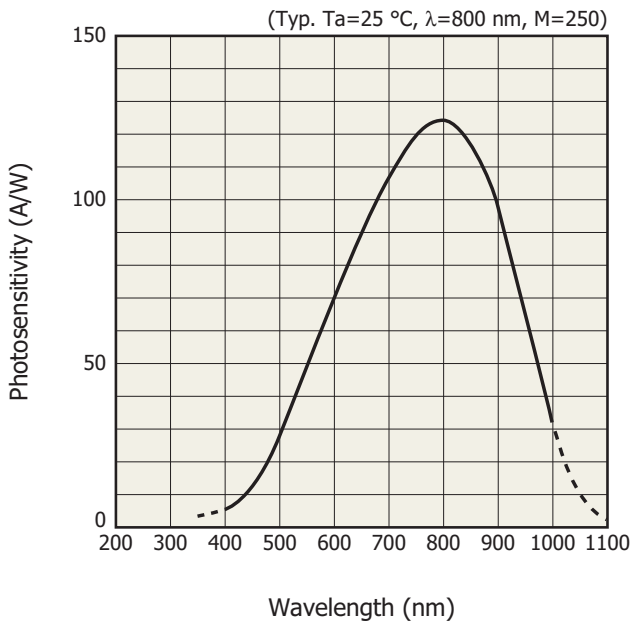

KACCB0183EA

Temperature characteristics of gain

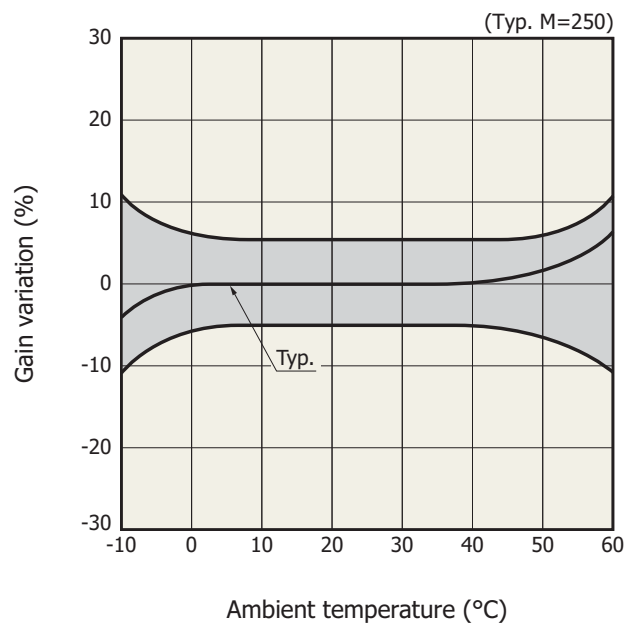

KACCB0185EA

Frequency characteristics (typical example)

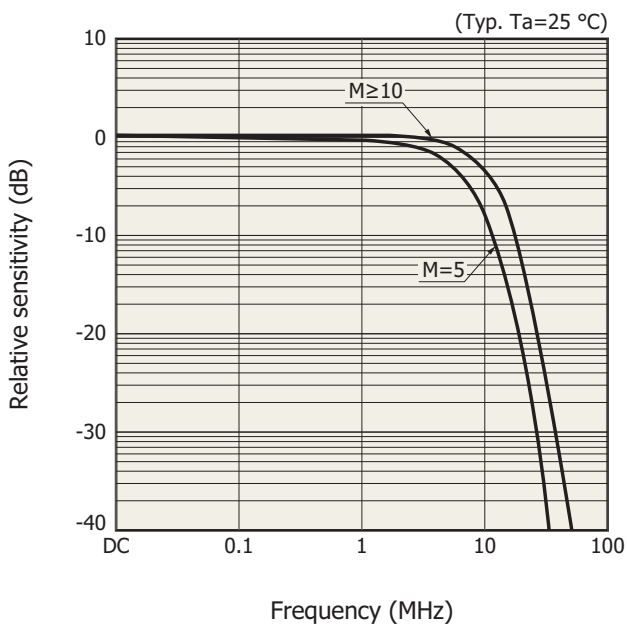

KACCB0184EA

Response to step light

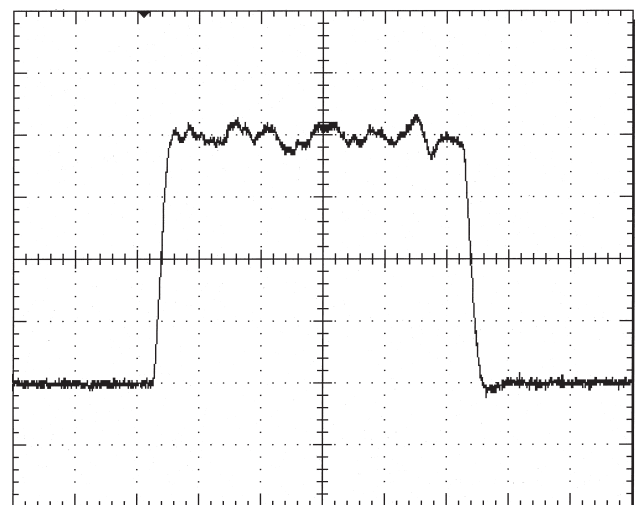

Typ., $T_a=25\text{ °C}$, $M=250$, incident pulse width $1\text{ }\mu\text{s}$
 X axis 200 ns/div. , Y axis 100 mV/div.

KACCC0399EA

Dimensional outline (unit: mm, tolerance unless otherwise noted: ±0.3)

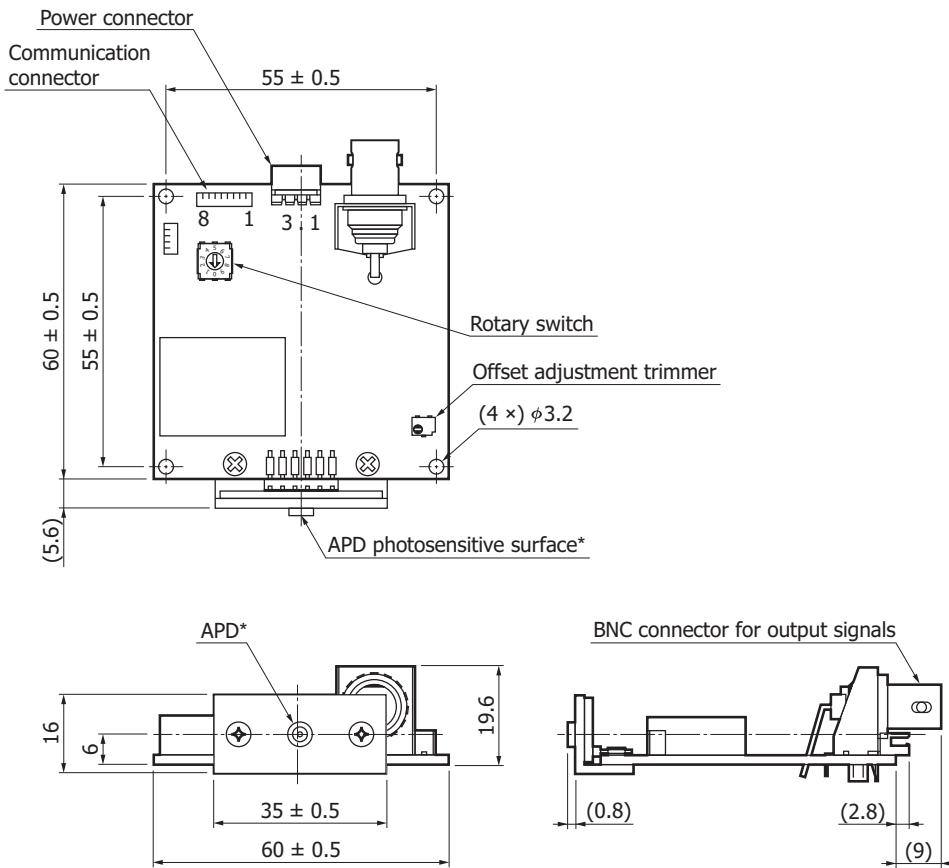

* Position accuracy of photosensitive area: ±0.3 mm with respect to APD package center

Power connector (cable included)
Molex: 5268-03A
① -5 V
② GND
③ +5 V

Communication connector (cable included)
Molex: 53047-0810
① GND
② DSR
③ RTS
④ Rx/D
⑤ CTS
⑥ DTR
⑦ Tx/D
⑧ DCD

KACCA0337EA

Gain adjustment method

Using the switch

The gain can be adjusted with the rotary switch on the circuit board. The following table indicates the relationship between the switch position and gain.

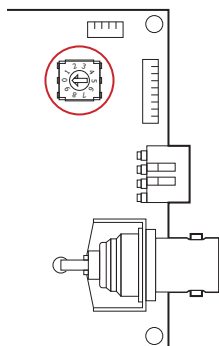

Position	Function
0	Not allowed
1	Gain: 10
2	Gain: 30
3	Gain: 50
4	Gain: 75
5	Gain: 100
6	Gain: 150
7	Gain: 250
8	Gain: User setting
9	PC control mode

Using commands from a PC

Set the switch position to 9 to enable PC control mode. The gain can be set to an integer value between 5 and 400.

Note that the setting is cleared when the power is turned off.

Communication with PC

Communication conditions

Baud rate : 9600 bps
 Data bits : 8-bit
 Parity : None
 Stop bits : 1-bit
 Flow control : None

Commands

Command	Description
#UG	Queries the current gain setting. The default gain is 10.
#US	Sets the gain to use when the switch is set to 9. The setting range is 5 to 400. A value outside the range will result in error. At power-on, the gain is set to the same setting as switch position 8.
#UW	Sets the gain to use when the switch is set to 8. The setting range is 5 to 400. A value outside the range will result in error. The value will be retained even after the power is turned off.

Send command format (ASCII code: 9 characters)

9	8	7	6	5	4	3	2	1
#	AA		xxxx			<CR>	<LF>	

No.	Description
9	#
8-7	Command (2 bytes: US/UG/UW)
6-3	Data (4 bytes: 0000 ... 9999)
2-1	Terminator (2 bytes: carriage return + line feed)

· Receive data format (ASCII code: 9 characters)

9	8	7	6	5	4	3	2	1
* or \$	AA		xxxx				<CR>	<LF>

No.	Description
9	* (normal) or \$ (error)
8-7	Command (2 bytes: echo back)
6-3	Data (4 bytes: 0000 ... 9999)
2-1	Terminator (2 bytes: carriage return + line feed)

Sample software

A sample software program is contained in the supplied CD-ROM. You can use it to control the C10508-01 from a PC. Please use it to check the operation.

· Sample software window

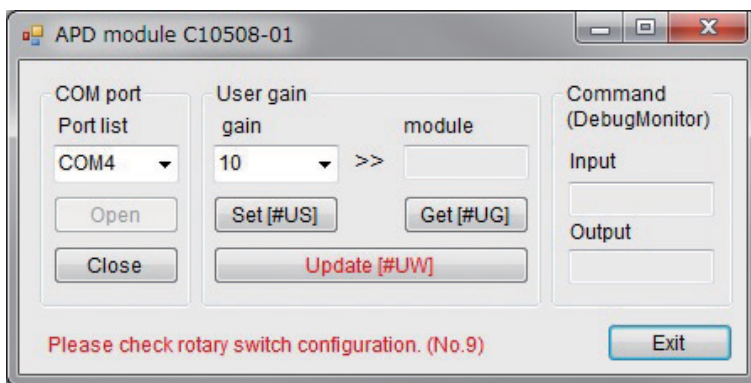

Accessories

- Power cable
- Communication cable
- D-sub connector
- CD-ROM (sample software, instruction manual)
- Quick start guide

Options (sold separately)

- FC fiber adapter A12855-01
- SMA fiber adapter A12855-02

Related information

www.hamamatsu.com/sp/ssd/doc_en.html

■ Precautions

· Notice

Information described in this material is current as of February, 2014.

Product specifications are subject to change without prior notice due to improvements or other reasons. This document has been carefully prepared and the information contained is believed to be accurate. In rare cases, however, there may be inaccuracies such as text errors. Before using these products, always contact us for the delivery specification sheet to check the latest specifications.

The product warranty is valid for one year after delivery and is limited to product repair or replacement for defects discovered and reported to us within that one year period. However, even if within the warranty period we accept absolutely no liability for any loss caused by natural disasters or improper product use.

Copying or reprinting the contents described in this material in whole or in part is prohibited without our prior permission.

HAMAMATSU

www.hamamatsu.com

HAMAMATSU PHOTONICS K.K., Solid State Division

1126-1 Ichino-cho, Higashi-ku, Hamamatsu City, 435-8558 Japan, Telephone: (81) 53-434-3311, Fax: (81) 53-434-5184

U.S.A.: Hamamatsu Corporation: 360 Foothill Road, Bridgewater, N.J. 08807, U.S.A., Telephone: (1) 908-231-0960, Fax: (1) 908-231-1218

Germany: Hamamatsu Photonics Deutschland GmbH: Arzbergerstr. 10, D-82211 Herrsching am Ammersee, Germany, Telephone: (49) 8152-375-0, Fax: (49) 8152-265-8

France: Hamamatsu Photonics France S.A.R.L.: 19, Rue du Saule Trapu, Parc du Moulin de Massy, 91882 Massy Cedex, France, Telephone: 33-(1) 69 53 71 00, Fax: 33-(1) 69 53 71 10

United Kingdom: Hamamatsu Photonics UK Limited: 2 Howard Court, 10 Tewin Road, Welwyn Garden City, Hertfordshire AL7 1BW, United Kingdom, Telephone: (44) 1707-294888, Fax: (44) 1707-325777

North Europe: Hamamatsu Photonics Norden AB: Torshamnsgatan 35 16440 Kista, Sweden, Telephone: (46) 8-509-031-00, Fax: (46) 8-509-031-01

Italy: Hamamatsu Photonics Italia S.r.l.: Strada della Moia, 1 int. 6, 20020 Arese (Milano), Italy, Telephone: (39) 02-93581733, Fax: (39) 02-93581741

China: Hamamatsu Photonics (China) Co., Ltd.: B1201, Jiaming Center, No.27 Dongsanhuan Beilu, Chaoyang District, Beijing 100020, China, Telephone: (86) 10-6586-6006, Fax: (86) 10-6586-2866