

SMTC1-1500



Phase Control Thyristor



Type	V_{RSM}	V_{RRM} , V_{DRM}
SMTC1-1500-6	700	600
SMTC1-1500-8	900	800
SMTC1-1500-10	1100	1000
SMTC1-1500-12	1300	1200
SMTC1-1500-14	1500	1400
SMTC1-1500-16	1700	1600

Type	I_{TAVM} $T_c=55^\circ\text{C}$	I_{TRMS}	I_{TSM}	$(di/dt)_{cr}$	$(dv/dt)_{cr}$	V_{TM}	I_{TM}	V_{TO}	r_T	t_q	V_{GT}	I_{GT}	T_{VJM}	R_{thJC}	F
	A	kA	kA	A/ μs	V/ μs	V	kA	V	m Ω	μs	V	mA	$^\circ\text{C}$	K/W	kN
SMTC1-1500	1500	2.83	20	200	1000	1.75	3.5	0.95	0.18	400	2.5	250	125	0.017	34

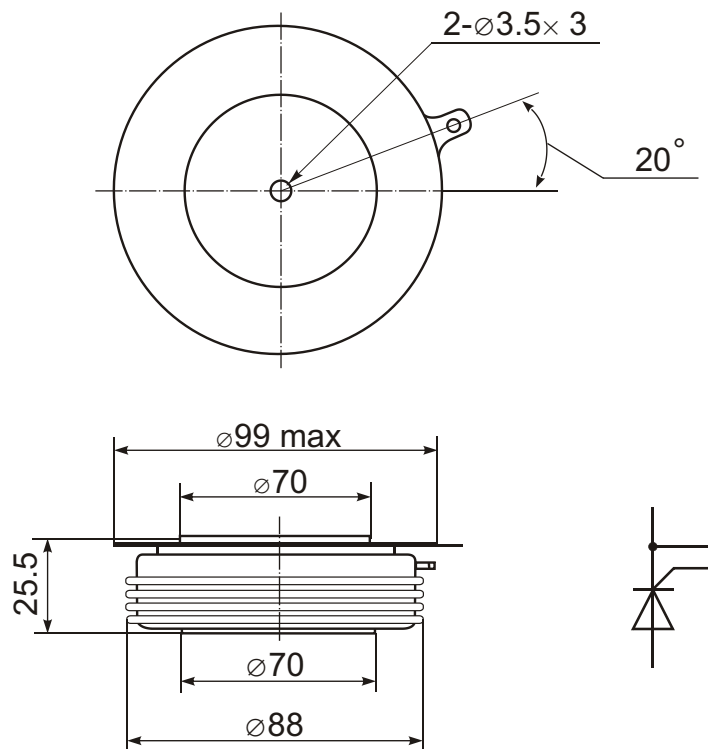

Features:

- Hermetic metal case with ceramic insulator
- Capsule packages for double sided cooling
- International standard case
- Amplifying gates

Typical Applications:

- DC motor control
- AC motor soft starter
- Controlled rectifiers
- AC controllers