

PRODUCT NUMBER

XXXXX-XYHPLF

- LEAD FREE OPTION  
SEE NOTE 1,13
- SPECIAL OPTIONS  
SEE NOTE 1 OR 10
- HIGH TEMPERATURE PLASTIC  
SEE NOTE 1
- NO OF POSITIONS  
SEE NOTE 1
- PIN PLATING  
SEE SHEET 2
- BASE PART NO.

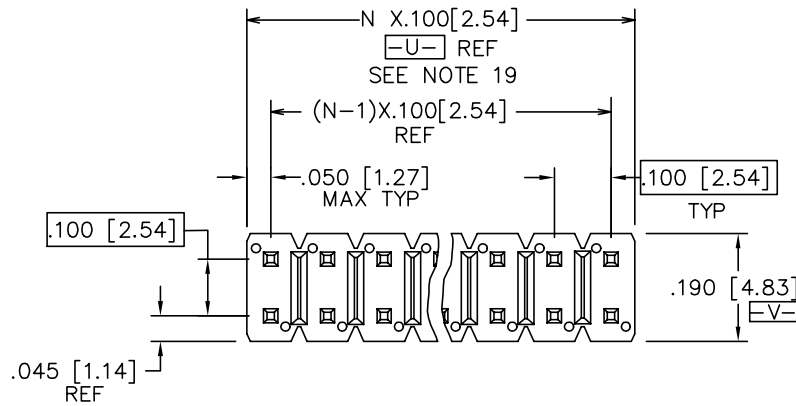

TOP VIEW



DETAIL P  
SCALE 5:1  
TYP BOTH ENDS



SIDE VIEW

END VIEW

67996-X XX-XXX XXX LF

- TAIL LENGTH (EXAMPLE BELOW)  
3.0mm=030 12.8mm=128  
(SEE NOTE 16 & 17)
- MATING LENGTH (EXAMPLE BELOW)  
5.0mm=050 25.5mm=255  
(SEE NOTE 16 & 17)
- TOTAL NUMBER OF POSITIONS  
FROM 2 (2X1) THRU 72 (2X36) POS.
- PIN PLATING (SEE NOTE 14)  
1=0.76µm Au  
4= PURE TIN  
8=0.36µm Au
- BASE PART NO.  
DOUBLE ROW

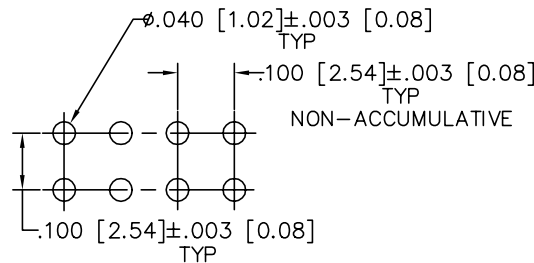

RECOMMENDED HOLE PATTERN

mat'l. code NOTE 2 & 3				surface ISO 1302 ✓	tolerance ISO 406 ISO 1101	projection INCH/MM	product family BERGSTIK
ltr	ecn no	dr	date	tolerances unless otherwise specified		scale 2:1	title BERGSTIK II HEADER D/R .100/2.54cc STRAIGHT
DF	N11-0180	J.Z	2011-05-31	angles	linear		
DG	ELX-N-13471	J.Z	2011-11-16				dwg no 67996
DH	ELX-N-16105	ZK	2013-10-22	0°±2'			
				dr	T.BREWBAKER	12/21/94	FCI
				enrg	T.HANNA	12/21/94	
				chr	J.MURPHY	12/21/94	
				appd	T.HANNA	12/21/94	type Product Customer Drawing
sheet index	revision sheet	DH	...	DH			
		1	...	8			

PIN PLATING CODES:	
XXXX-1YY	30u"/0.76u MIN (SEE NOTE 14) OVER 50u"/1.27u MIN Ni
XXXX-2YY	15u"/0.38u MIN (SEE NOTE 14) OVER 50u"/1.27u MIN Ni
XXXX-3YY	50u"/1.27u MIN (SEE NOTE 14) OVER 50u"/1.27u MIN Ni
XXXX-4YY	100u"/2.54u MIN Sn OVER 50u"/1.27u MIN Ni (SEE NOTE 15)
XXXX-4YYHLF	
XXXX-5YY	15u"/0.38u MIN (SEE NOTE 14) OVER 50u"/1.27u MIN Ni
XXXX-6YY	30u"/0.76u MIN (SEE NOTE 14) OVER 50u"/1.27u MIN Ni
XXXX-7YY	30u"/0.76u MIN (SEE NOTE 14) OVER 50u"/1.27u MIN Ni
XXXX-8YY	15u"/0.38u MIN (SEE NOTE 14) OVER 50u"/1.27u MIN Ni
XXXX-9YY	15u"/0.38u MIN (SEE NOTE 14) OVER 50u"/1.27u MIN Ni
XXXX-0YY	30u"/0.76u MIN (SEE NOTE 14) OVER 50u"/1.27u MIN Ni

- PIN MATERIAL: PHOS BRONZE.
- MEASURED WITH PART IN RESTRAINED CONDITION.
- TWO SIDES OF PIN TIPS NOT PLATED. TYPICAL BOTH ENDS.
- 2LBS/0.9KG MIN PIN RETENTION IN EITHER DIRECTION.
- MILITARY BERGSTIK HEADER  
P/N XXXXX-XYX-MIL  
NOT AVAILABLE.
- ±.010/0.25 TOL APPLIES TO ALL "G" TAILS EXCEPT INDICATED PARTS ON TABLE WHERE +.010/0.25 -.000/0.00 APPLIES.
- NOTCH CONFIGURATION WILL VARY PER VENDOR'S DISCRETION.
- BERGSTRIPTM PART NUMBERS FOLLOWED BY BY A "B" ARE BULK PRICED.
- TAIL LENGTH (DIM. G) TO BE ±.008/.020.
- POSITIONS PER ROW 37 TO 50 CAN BE PRODUCED, BUT FLATNESS AND CURVATURE MAY NOT BE HELD AS CLOSE AS 36 POSITIONS.
- THESE PRODUCTS MEETS EUROPEAN UNION DIRECTIVES AND OTHER COUNTRY REGULATION AS DESCRIBED IN GS-22-008.
- PLATING OPTIONS:  
PERFORMANCE PLATING WILL BE EITHER GOLD OR GXT ON POST OR TAIL, OPTIONALLY (78~295u"/2~7.5u) TIN ON TAIL.
- "THIS PRODUCT HAS 100% TIN PLATING IN THE INTERFACE AND HAS NOT BEEN TESTED FOR WHISKER GROWTH IN ALL INTERCONNECT ENVIRONMENTS."
- THE OAL DON'T EXCEED 34.5mm
- INCREMENTS BY 0.1mm IN LENGTHS ONLY
- FOR SPECIAL PACKAGING REQUEST PLEASE CONTACT PRODUCT MANAGER FOR AVAILABILITY
- TO DETERMINE DIMENSIONS:  
N=NUMBER OF POSITION PER ROW  
EXAMPLE: 10 POS. N X .100/2.54

NOTES

1. PART NUMBER OPTIONS:  
PIN PLATING CODES (SEE ABOVE)

HIGH TEMPERATURE MATERIAL:

PART NUMBERS WITH AND WITHOUT "H" WILL BE SUPPLIED WITH HIGH TEMPERATURE PLASTIC.

NUMBER OF POSITIONS :

EVEN NUMBER OF POSITIONS FROM 2 (2X1) THROUGH 72 (2X36).  
-X00H INDICATES BERGSTRIPTM PRODUCT. SEE PAGE 3  
FOR SPECIAL GEOMETRY OF THIS CONTINUOUS STRIP PRODUCT.  
AUTOMATED REELS WILL CONTAIN 45,000 PINS.  
SEE SPECIFIC PART NUMBERS FOR AVAILABILITY.

PACKAGING:

PACKAGED IN POLY BAGS.  
EIGHT DIGIT PART NUMBERS FOLLOWED BY A "T" ARE PACKAGED IN TUBES. SEE SPECIFIC PART NUMBERS FOR AVAILABILITY.  
EIGHT DIGIT PART NUMBERS FOLLOWED BY A "G" ARE PACKAGED IN GPAX FOR IBM ONLY. SEE SPECIFIC PART NUMBERS FOR AVAILABILITY.  
PART NUMBERS FOLLOWED BY A "C" ARE PACKAGED IN TUBES WITH A PICKUP CAP APPLIED.  
EIGHT DIGIT PART NUMBERS FOLLOWED BY A "A" ARE PACKAGED IN TAPE/REEL WITH PICKUP CAP P/N 95730-003 APPLIED, PER BUS-14-345.

LEAD FREE:

ADD "HLF" SUFFIX AT THE END OF PART NUMBER FOR LEAD FREE OPTION, NOT AVAILABLE FOR -5YY,-5YYH, -6YY & -6YYH

2. BODY MATERIAL:

BODY MATERIAL : MANUFACTURER'S OPTION OF NYLON, PCT GLASS FIBER REINFORCED OR MINERAL FILLED LCP FLAME RETARDENT PER UL-94V-0.  
COLOR: BLACK  
BERGSTRIPTM PRODUCED WITH HIGH TEMPERATURE LCP THERMOPLASTIC, FLAME RETARDENT PER UL-94V-0.  
COLOR: BLACK  
PART NUMBERS WITH "H" AND WITHOUT SUFFIX WILL WITHSTAND EXPOSURE TO 260° C PEAK TEMPERATURE FOR 20 SECONDS IN WAVE SOLDER, INFRA-RED OR VAPOR PHASE SOLDER PROCESS.

mat'l. code		surface		tolerance		projection		product family	
NOTE 2 & 3		ISO 1302 ✓		ISO 406		ISO 1101		BERGSTIK	
ltr	ecn	no	dr	date	tolerances unless otherwise specified		INCH/MM	title	
DG					angles	linear		scale 2:1	BERGSTIK II HEADER D/R
					0°±2'				.100/2.54cc STRAIGHT
					dr	T.BREWBAKER	12/21/94	dwg no	
					enrg	T.HANNA	12/21/94	sheet 2 of 8	
					chr	J.MURPHY	12/21/94	67996	
					appd	T.HANNA	12/21/94	A3	
sheet index		revision sheet						type Product Customer Drawing	

BERGSTRIPTM HEADER

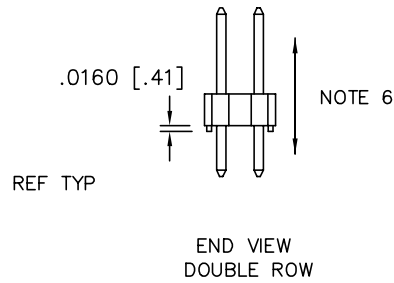
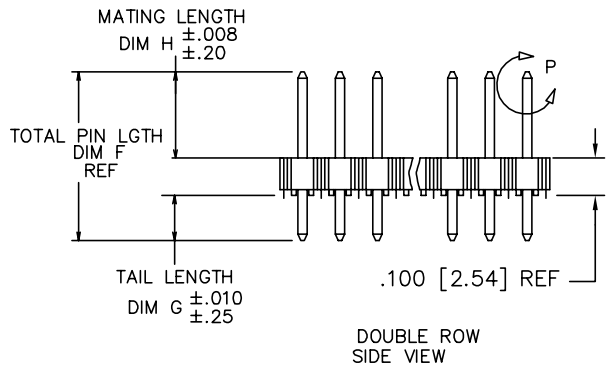
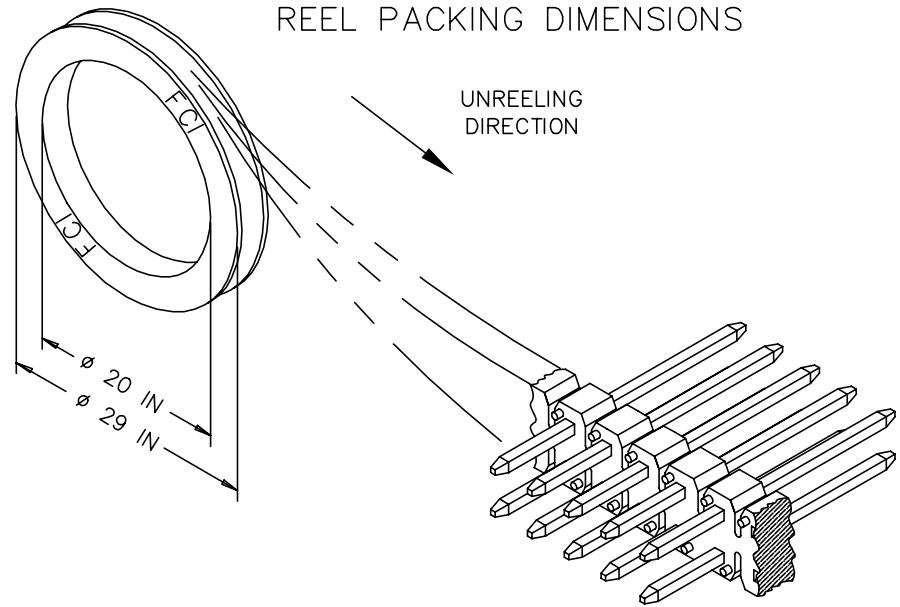
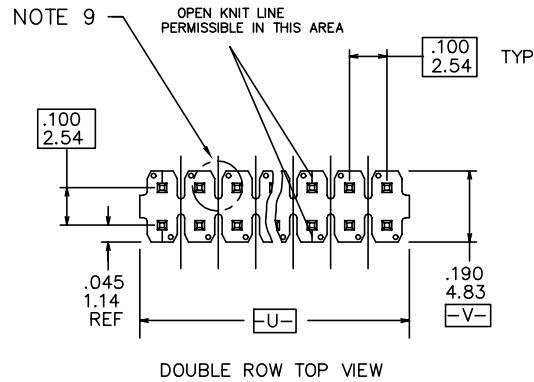

mat'l. code NOTE 2 & 3		surface ISO 1302 ✓	tolerance ISO 406 ISO 1101	projection INCH/MM	product family BERGSTIK
ltr	ecn no	dr	date	tolerances unless otherwise specified	title BERGSTIK II HEADER D/R .100/2.54cc STRAIGHT
DH				angles linear XXX±0.005/XXX±.13 0°±2° XXXX±0.020/XXX±.051	scale 2:1
		dr	T.BREWBAKER	12/21/94	dwg no 67996
		enr	T.HANNA	12/21/94	sheet 3 of 8 size A3
		chr	J.MURPHY	12/21/94	
		appd	T.HANNA	12/21/94	type Product Customer Drawing
sheet index	revision sheet				

FCIconnect.com  
Copyright FCI

PRODUCT NUMBER	1		TAIL LENGTH		2 3		MATING LENGTH	PACKAGING	NOTES	BERGSTRIIP™ AVAILABLE	LF OPTION	
	TOT. PIN LGTH.	DIM F	DIM G	DIM G	DIM H	DIM H						
	ENGLISH	METRIC	ENGLISH	METRIC	ENGLISH	METRIC						
55005-XYH	0.597	15.16	0.095	2.41	0.402	10.21		POLY BAGS		YES	OB NOTE 1,13	
55030-XYH	0.630	16.00	0.150	3.81	0.380	9.65		POLY BAGS		YES		
67996-XYH	0.425	10.80	0.095	2.41	0.230	5.84		POLY BAGS/TUBES		YES		
67997-XYH	0.450	11.43	0.120	3.05	0.230	5.84		POLY BAGS/TUBES		YES		
67997-XYH	0.450	11.43	0.120	3.05	0.230	5.84		POLY BAGS/TUBES		YES		
67998-XYH	0.525	13.34	0.107	2.72	0.318	8.08		POLY BAGS/TUBES		YES		
67999-XYH	0.548	13.92	0.130	3.30	0.318	8.08		POLY BAGS		NO		
68438-XYH	0.555	14.10	0.225	5.72	0.230	5.84		POLY BAGS/TUBES		NO		OB
68439-XYH	0.720	18.29	0.120	3.05	0.500	12.70		POLY BAGS		NO		
68464-XYH	0.650	16.51	0.120	3.05	0.430	10.92		POLY BAGS/TUBES		NO		OB
68481-XYH	0.480	12.19	0.095	2.41	0.285	7.24		POLY BAGS/TUBES		NO		
68482-XYH	0.938	23.83	0.318	8.08	0.520	13.21		POLY BAGS		NO		
68491-XYH	0.475	12.07	0.120	3.05	0.255	6.48		POLY BAGS/TUBES		NO		
68600-XYH	0.825	20.96	0.115	2.92	0.610	15.49		POLY BAGS		NO		
68601-XYH	0.620	15.75	0.120	3.05	0.400	10.16		POLY BAGS		NO		
68602-XYH	0.480	12.19	0.150	3.81	0.230	5.84		POLY BAGS		YES		
68690-XYH	0.533	13.54	0.115	2.92	0.318	8.08		POLY BAGS		NO		
68691-XYH	0.538	13.67	0.120	3.05	0.318	8.08		POLY BAGS		YES		
68692-XYH	0.430	10.92	0.100	2.54	0.230	5.84		POLY BAGS		NO		
68693-XYH	0.938	23.83	0.520	13.21	0.318	8.08		POLY BAGS		NO	OB	
68716-XYH	0.828	21.03	0.410	10.41	0.318	8.08		POLY BAGS		NO		
68734-XYH	0.615	15.62	0.230	5.84	0.285	7.24		POLY BAGS		NO		
68737-XYH	0.440	11.18	0.110	2.79	0.230	5.84		POLY BAGS		YES		
68738-XYH	0.615	15.62	0.115	2.92	0.400	10.16		POLY BAGS		NO		
68739-XYH	0.486	12.34	0.156	3.96	0.230	5.84		POLY BAGS		NO		
68743-XYH	0.638	16.21	0.220	5.59	0.318	8.08		POLY BAGS		NO		
68749-XYH	0.838	21.29	0.420	10.67	0.318	8.08		POLY BAGS		NO		
68779-XYH	0.736	18.69	0.318	8.08	0.318	8.08		POLY BAGS		NO		
68783-XYH	0.375	9.53	0.045	1.14	0.230	5.84		POLY BAGS		NO		
68799-XYH	0.925	23.50	0.595	15.11	0.230	5.84		POLY BAGS		NO	OBNOTE 1,13	



Fciconnect.com

Copyright FCI

mat'l. code NOTE 2 & 3		surface ISO 1302 ✓	tolerance ISO 406 ISO 1101	projection 	product family BERGSTIK
ltr	ecn no	dr	date	tolerances unless otherwise specified	title
DH				angles linear XX±01/XX±3 XXX±0.006/XXX±.13 XXXX±0020/XXX±.05	BERGSTIK II HEADER D/R .100/2.54cc STRAIGHT
				0°±2'	INCH/MM scale 2:1
		dr	T.BREWBAKER	12/21/94	dwg no sheet 4 of 8 size
		enr	T.HANNA	12/21/94	67996 A3
		chr	J.MURPHY	12/21/94	
		appd	T.HANNA	12/21/94	type Product Customer Drawing
sheet index	revision sheet				

PRODUCT NUMBER	TOT. PIN LGTH.		TAIL LENGTH		MATING LENGTH		PACKAGING	NOTES	BERGSTRIPTM AVAILABLE	LF OPTION
	DIM F	DIM F	DIM G	DIM G	DIM H	DIM H				
	ENGLISH	METRIC	ENGLISH	METRIC	ENGLISH	METRIC				
<del>69132</del> -XYY	<del>0.760</del>	<del>19.30</del>	<del>0.120</del>	<del>3.05</del>	<del>0.540</del>	<del>13.72</del>	POLY BAGS/TUBES		NO	OB NOTE 1,13
69133-XYY	0.615	15.62	0.285	7.24	0.230	5.84	POLY BAGS		NO	
69157-XYY	0.410	10.41	0.110	2.79	0.200	5.08	POLY BAGS		NO	
<del>71217</del> -XYYH	<del>1.000</del>	<del>25.40</del>	<del>0.450</del>	<del>11.43</del>	<del>0.450</del>	<del>11.43</del>	POLY BAGS		NO	
<del>71222</del> -XYYH	<del>0.850</del>	<del>21.59</del>	<del>0.250</del>	<del>6.35</del>	<del>0.500</del>	<del>12.70</del>	POLY BAGS		NO	
<del>72273</del> -XYYH	<del>0.725</del>	<del>18.42</del>	<del>0.110</del>	<del>2.79</del>	<del>0.515</del>	<del>13.08</del>	POLY BAGS		NO	
<del>72448</del> -XYYH	<del>0.658</del>	<del>16.71</del>	<del>0.172</del>	<del>4.37</del>	<del>0.386</del>	<del>9.80</del>	POLY BAGS		NO	
<del>72455</del> -XYYH	<del>0.598</del>	<del>15.19</del>	<del>0.180</del>	<del>4.57</del>	<del>0.318</del>	<del>8.08</del>	POLY BAGS		NO	
72455-632HG	0.598	15.19	0.180	4.57	0.318	8.08	GPAX	NOTE 1	NO	
<del>73503</del> -XYYH	<del>0.420</del>	<del>10.67</del>	<del>0.120</del>	<del>3.05</del>	<del>0.200</del>	<del>5.08</del>	POLY BAGS		NO	
<del>73596</del> -XYYH	<del>0.795</del>	<del>20.19</del>	<del>0.110</del>	<del>2.79</del>	<del>0.585</del>	<del>14.86</del>	POLY BAGS		NO	
<del>74317</del> -XYYH	<del>0.532</del>	<del>13.51</del>	<del>0.309</del>	<del>7.85</del>	<del>0.123</del>	<del>3.12</del>	POLY BAGS	NOTE 11	NO	
<del>74318</del> -XYYH	<del>0.592</del>	<del>15.04</del>	<del>0.369</del>	<del>9.37</del>	<del>0.123</del>	<del>3.12</del>	POLY BAGS	NOTE 11	NO	
<del>74999</del> -XYYH	<del>0.508</del>	<del>12.90</del>	<del>0.090</del>	<del>2.29</del>	<del>0.318</del>	<del>8.08</del>	POLY BAGS		NO	
<del>78212</del> -XYY	<del>0.710</del>	<del>18.03</del>	<del>0.350</del>	<del>8.89</del>	<del>0.260</del>	<del>6.60</del>	POLY BAGS		NO	
78233-XYY	0.568	14.43	0.150	3.81	0.318	8.08	POLY BAGS		NO	
<del>78269</del> -XYY	<del>0.385</del>	<del>9.78</del>	<del>0.095</del>	<del>2.41</del>	<del>0.190</del>	<del>4.83</del>	POLY BAGS		NO	
<del>78286</del> -XYY	<del>0.500</del>	<del>12.70</del>	<del>0.160</del>	<del>4.06</del>	<del>0.240</del>	<del>6.10</del>	POLY BAGS/TUBES		NO	
78932-XYY		UNAVAILABLE		UNAVAILABLE		UNAVAILABLE				
<del>78933</del> -XYY	<del>0.695</del>	<del>17.65</del>	<del>0.285</del>	<del>7.24</del>	<del>0.310</del>	<del>7.87</del>	POLY BAGS		NO	
<del>78988</del> -XYY	<del>0.540</del>	<del>13.72</del>	<del>0.135</del>	<del>3.43</del>	<del>0.305</del>	<del>7.75</del>	POLY BAGS		NO	
78989-XYY		UNAVAILABLE		UNAVAILABLE		UNAVAILABLE				
78990-XYY		UNAVAILABLE		UNAVAILABLE		UNAVAILABLE				
78991-XYY		UNAVAILABLE		UNAVAILABLE		UNAVAILABLE				
78992-XYY		UNAVAILABLE		UNAVAILABLE		UNAVAILABLE				
78993-XYY		UNAVAILABLE		UNAVAILABLE		UNAVAILABLE				
78994-XYY		UNAVAILABLE		UNAVAILABLE		UNAVAILABLE				

NOTE 1,13

mat'l. code NOTE 2 & 3		surface ISO 1302 <input checked="" type="checkbox"/>	tolerance ISO 406 ISO 1101	projection 	product family BERGSTIK
ltr	ecn no	dr	date	tolerances unless otherwise specified	title
DH				linear XX±01/XX±3 XXX±0.006/XXX±.13 XXXX±0020/XXX±.05	BERGSTIK II HEADER D/R .100/2.54cc STRAIGHT
				angles 0°±2'	INCH/MM scale 2:1
		dr	T.BREWBAKER	12/21/94	dwg no
		enr	T.HANNA	12/21/94	sheet 5 of 8
		chr	J.MURPHY	12/21/94	size
		appd	T.HANNA	12/21/94	67996
					A3
					type Product Customer Drawing
sheet index	revision sheet				

PRODUCT NUMBER	TOT. PIN LGTH.		TAIL LENGTH		MATING LENGTH		PACKAGING	NOTES	BERGSTRIPTM AVAILABLE	LF OPTION
	DIM F	DIM F	DIM G	DIM G	DIM H	DIM H				
	ENGLISH	METRIC	ENGLISH	METRIC	ENGLISH	METRIC				
78995-XY	UNAVAILABLE		UNAVAILABLE		UNAVAILABLE		E	-	-	NOTE 1,13
78996-XY	UNAVAILABLE		UNAVAILABLE		UNAVAILABLE		E	-	-	
<del>79242-XY</del>	<del>0.930</del>	<del>23.62</del>	<del>0.340</del>	<del>8.64</del>	<del>0.490</del>	<del>12.45</del>	<del>POLY BAGS</del>	<del>-</del>	<del>NO</del>	OB
<del>79243-XY</del>	<del>1.230</del>	<del>31.24</del>	<del>0.390</del>	<del>9.91</del>	<del>0.740</del>	<del>18.80</del>	<del>POLY BAGS</del>	<del>-</del>	<del>NO</del>	OB
79244-XY	UNAVAILABLE		UNAVAILABLE		UNAVAILABLE		E	-	-	
<del>79268-XY</del>	<del>1.020</del>	<del>25.91</del>	<del>0.120</del>	<del>3.05</del>	<del>0.800</del>	<del>20.32</del>	<del>POLY BAGS</del>	<del>-</del>	<del>NO</del>	OB
<del>79271-XY</del>	<del>1.100</del>	<del>27.94</del>	<del>0.500</del>	<del>12.70</del>	<del>0.500</del>	<del>12.70</del>	<del>POLY BAGS</del>	<del>-</del>	<del>NO</del>	OB
79425-XY	0.410	10.41	0.120	3.05	0.190	4.83	POLY BAGS	-	NO	
79821-XY	0.730	18.54	0.200	5.08	0.430	10.92	POLY BAGS	-	NO	
<del>84610-XYH</del>	<del>0.380</del>	<del>9.65</del>	<del>0.120</del>	<del>3.05</del>	<del>0.160</del>	<del>4.06</del>	<del>POLY BAGS</del>	<del>-</del>	<del>NO</del>	OB
<del>84760-XYH</del>	<del>0.870</del>	<del>22.09</del>	<del>0.150</del>	<del>3.81</del>	<del>0.620</del>	<del>15.74</del>	<del>POLY BAGS</del>	<del>-</del>	<del>NO</del>	OB
<del>84784-XYH</del>	<del>1.130</del>	<del>28.70</del>	<del>0.122</del>	<del>3.09</del>	<del>0.908</del>	<del>23.06</del>	<del>POLY BAGS</del>	<del>-</del>	<del>NO</del>	OB
<del>84934-XYH</del>	<del>1.375</del>	<del>34.93</del>	<del>0.625</del>	<del>15.88</del>	<del>0.650</del>	<del>16.51</del>	<del>POLY BAGS</del>	<del>-</del>	<del>NO</del>	OB
<del>84976-XYH</del>	<del>0.730</del>	<del>18.54</del>	<del>0.400</del>	<del>10.16</del>	<del>0.230</del>	<del>5.84</del>	<del>POLY BAGS</del>	<del>-</del>	<del>NO</del>	OB
86503-XY	0.470	11.94	0.120	3.05	0.250	6.35	POLY BAGS	-	NO	
<del>86581-XY</del>	<del>0.450</del>	<del>11.43</del>	<del>0.120</del>	<del>3.05</del>	<del>0.230</del>	<del>5.84</del>	<del>POLY BAGS</del>	<del>NOTE 8</del>	<del>NO</del>	OB
<del>86817-XY</del>	<del>0.925</del>	<del>23.50</del>	<del>0.120</del>	<del>3.05</del>	<del>0.705</del>	<del>17.91</del>	<del>POLY BAGS</del>	<del>-</del>	<del>NO</del>	OB
<del>86827-XY</del>	<del>0.700</del>	<del>17.78</del>	<del>0.120</del>	<del>3.05</del>	<del>0.480</del>	<del>12.19</del>	<del>POLY BAGS</del>	<del>-</del>	<del>NO</del>	OB
86832-XY	0.525	13.34	0.100	2.54	0.325	8.26	POLY BAGS	-	NO	
<del>86834-XY</del>	<del>1.335</del>	<del>33.91</del>	<del>0.585</del>	<del>14.86</del>	<del>0.650</del>	<del>16.51</del>	<del>POLY BAGS</del>	<del>-</del>	<del>NO</del>	OB
<del>86836-XY</del>	<del>0.870</del>	<del>22.10</del>	<del>0.120</del>	<del>3.05</del>	<del>0.650</del>	<del>16.51</del>	<del>POLY BAGS</del>	<del>-</del>	<del>NO</del>	OB
86837-XY	0.600	15.24	0.120	3.05	0.380	9.65	POLY BAGS	-	NO	
<del>87037-XY</del>	<del>1.240</del>	<del>31.50</del>	<del>0.120</del>	<del>3.05</del>	<del>1.020</del>	<del>25.91</del>	<del>POLY BAGS</del>	<del>-</del>	<del>NO</del>	OB
87052-XY	0.990	25.15	0.120	3.05	0.770	19.56	POLY BAGS	-	NO	
<del>87203-XY</del>	<del>0.545</del>	<del>13.84</del>	<del>0.150</del>	<del>3.81</del>	<del>0.295</del>	<del>7.49</del>	<del>POLY BAGS</del>	<del>-</del>	<del>NO</del>	OB
<del>87344-XY</del>	<del>1.375</del>	<del>34.93</del>	<del>0.219</del>	<del>5.56</del>	<del>1.056</del>	<del>26.82</del>	<del>POLY BAGS</del>	<del>-</del>	<del>NO</del>	OB NOTE 1,13

mat'l. code NOTE 2 & 3		surface ISO 1302 <input checked="" type="checkbox"/>	tolerance ISO 406 ISO 1101	projection 	product family BERGSTIK
ltr	ecn no	dr	date	tolerances unless otherwise specified	title
DH				angles linear XX±01/XX±3 XXX±0.006/XXX±.13 XXXX±0020/XXX±.05	BERGSTIK II HEADER D/R .100/2.54cc STRAIGHT
				0°±2'	INCH/MM scale 2:1
		dr	T.BREWBAKER	12/21/94	dwg no sheet 6 of 8 size
		enr	T.HANNA	12/21/94	67996 A3
		chr	J.MURPHY	12/21/94	
		appd	T.HANNA	12/21/94	type Product Customer Drawing
sheet index	revision sheet				

PRODUCT NUMBER	TOT. PIN LGTH.		TAIL LENGTH		MATING LENGTH		PACKAGING	NOTES	BERGSTRIPT™ AVAILABLE	LF OPTION
	DIM F	DIM F	DIM G	DIM G	DIM H	DIM H				
	ENGLISH	METRIC	ENGLISH	METRIC	ENGLISH	METRIC				
<del>87345-XYY</del>	<del>1.218</del>	<del>30.94</del>	<del>0.406</del>	<del>10.31</del>	<del>0.712</del>	<del>18.08</del>	<del>POLY BAGS</del>	<del>---</del>	<del>NO</del>	OB NOTE 1,13 OB
<del>87348-XYY</del>	<del>0.930</del>	<del>23.62</del>	<del>0.100</del>	<del>2.54</del>	<del>0.730</del>	<del>18.54</del>	<del>POLY BAGS</del>	<del>---</del>	<del>NO</del>	
<del>87349-XYY</del>	<del>0.890</del>	<del>22.61</del>	<del>0.110</del>	<del>2.79</del>	<del>0.680</del>	<del>17.27</del>	<del>POLY BAGS</del>	<del>---</del>	<del>NO</del>	
<del>87381-XYY</del>	<del>0.645</del>	<del>16.38</del>	<del>0.100</del>	<del>2.54</del>	<del>0.445</del>	<del>11.30</del>	<del>POLY BAGS</del>	<del>---</del>	<del>NO</del>	
<del>87382-XYY</del>	<del>0.675</del>	<del>17.15</del>	<del>0.100</del>	<del>2.54</del>	<del>0.475</del>	<del>12.07</del>	<del>POLY BAGS</del>	<del>---</del>	<del>NO</del>	
<del>87503-XYYH</del>	<del>0.630</del>	<del>16.00</del>	<del>0.110</del>	<del>2.79</del>	<del>0.420</del>	<del>10.67</del>	<del>POLY BAGS</del>	<del>---</del>	<del>NO</del>	
<del>87869-XYY</del>	<del>0.690</del>	<del>17.53</del>	<del>0.230</del>	<del>5.84</del>	<del>0.360</del>	<del>9.14</del>	<del>POLY BAGS</del>	<del>---</del>	<del>NO</del>	
87894-XYY	0.588	14.94	0.170	4.32	0.318	8.08	POLY BAGS	-	NO	
87900-XYY	0.940	23.88	0.120	3.05	0.720	18.29	POLY BAGS	-	NO	
87901-XYY	1.040	26.42	0.120	3.05	0.820	20.83	POLY BAGS	-	NO	
<del>87903-XYY</del>	<del>0.963</del>	<del>24.46</del>	<del>0.337</del>	<del>8.56</del>	<del>0.526</del>	<del>13.36</del>	<del>POLY BAGS</del>	<del>---</del>	<del>NO</del>	
<del>88797-XYY</del>	<del>0.950</del>	<del>24.13</del>	<del>0.320</del>	<del>8.13</del>	<del>0.530</del>	<del>13.46</del>	<del>POLY BAGS</del>	<del>---</del>	<del>NO</del>	
<del>88812-XYY</del>	<del>0.415</del>	<del>10.54</del>	<del>0.085</del>	<del>2.16</del>	<del>0.230</del>	<del>5.84</del>	<del>POLY BAGS/TUBES</del>	<del>NOTE 8</del>	<del>NO</del>	
<del>88886-XYY</del>	<del>1.306</del>	<del>33.17</del>	<del>0.276</del>	<del>7.01</del>	<del>0.930</del>	<del>23.62</del>	<del>POLY BAGS</del>	<del>---</del>	<del>NO</del>	
<del>89446-XYY</del>	<del>0.930</del>	<del>23.62</del>	<del>0.120</del>	<del>3.05</del>	<del>0.710</del>	<del>18.03</del>	<del>POLY BAGS</del>	<del>---</del>	<del>NO</del>	
<del>89540-XYY</del>	<del>0.760</del>	<del>19.30</del>	<del>0.280</del>	<del>7.11</del>	<del>0.380</del>	<del>9.65</del>	<del>POLY BAGS</del>	<del>---</del>	<del>NO</del>	
<del>89542-XYY</del>	<del>1.065</del>	<del>27.05</del>	<del>0.125</del>	<del>3.18</del>	<del>0.840</del>	<del>21.34</del>	<del>POLY BAGS</del>	<del>---</del>	<del>NO</del>	
<del>89639-XYY</del>	<del>1.260</del>	<del>32.00</del>	<del>0.118</del>	<del>3.00</del>	<del>1.042</del>	<del>26.47</del>	<del>POLY BAGS</del>	<del>---</del>	<del>NO</del>	
<del>91828-XYY</del>	<del>0.450</del>	<del>11.43</del>	<del>0.120</del>	<del>3.05</del>	<del>0.230</del>	<del>5.84</del>	<del>TUBES</del>	<del>---</del>	<del>NO</del>	
92417-XYY	0.530	13.46	0.110	2.79	0.320	8.13	POLY BAGS	-	NO	
<del>93216-XYYH</del>	<del>0.573</del>	<del>14.55</del>	<del>0.155</del>	<del>3.94</del>	<del>0.318</del>	<del>8.08</del>	<del>POLY BAGS/TUBES</del>	<del>---</del>	<del>NO</del>	
<del>93216-632HG</del>	<del>0.573</del>	<del>14.55</del>	<del>0.155</del>	<del>3.94</del>	<del>0.318</del>	<del>8.08</del>	<del>GPAX</del>	<del>NOTE 1</del>	<del>NO</del>	
<del>93217-XYYH</del>	<del>0.395</del>	<del>10.03</del>	<del>0.095</del>	<del>2.41</del>	<del>0.200</del>	<del>5.08</del>	<del>POLY BAGS</del>	<del>---</del>	<del>NO</del>	
93254-XYY	0.563	14.30	0.110	2.79	0.353	8.97	POLY BAGS	-	NO	

mat'l. code NOTE 2 & 3	surface ISO 1302 ✓	tolerance ISO 406 ISO 1101	projection 	product family BERGSTIK
ltr	ecn no	dr	date	tolerances unless otherwise specified
DH				angles linear XX±01/XX±3 XXX±0.006/XXX±.13 XXXX±0.020/XXXX±.051
				0°±2'
				dr T.BREWBAKER 12/21/94
				enr T.HANNA 12/21/94
				chr J.MURPHY 12/21/94
				appd T.HANNA 12/21/94
sheet index	revision sheet			

title BERGSTIK II HEADER D/R .100/2.54cc STRAIGHT	dwg no 67996	sheet 7 of 8 size A3
type Product Customer Drawing		

PRODUCT NUMBER	TOT. PIN LGTH.		TAIL LENGTH		MATING LENGTH		PACKAGING	NOTES	BERGSTRIK AVAILABLE	LF OPTION
	DIM F	DIM F	DIM G	DIM G	DIM H	DIM H				
	ENGLISH	METRIC	ENGLISH	METRIC	ENGLISH	METRIC				
<del>94010-XYH</del>	<del>0.756</del>	<del>19.20</del>	<del>0.350</del>	<del>8.89</del>	<del>0.306</del>	<del>7.77</del>	<del>POLY BAGS</del>	<del>---</del>	<del>NO</del>	OB NOTE 1,13 OB OB OB OB OB OB OB OB OB OB OB OB OB
<del>94532-XYH</del>	<del>1.250</del>	<del>31.75</del>	<del>0.450</del>	<del>11.43</del>	<del>0.700</del>	<del>17.78</del>	<del>POLY BAGS</del>	<del>---</del>	<del>NO</del>	
<del>95105-XY</del>	<del>0.370</del>	<del>9.40</del>	<del>0.126</del>	<del>3.20</del>	<del>0.144</del>	<del>3.66</del>	<del>POLY BAGS</del>	<del>---</del>	<del>NO</del>	
<del>95645-XYH</del>	<del>0.350</del>	<del>8.89</del>	<del>0.100</del>	<del>2.54</del>	<del>0.150</del>	<del>3.81</del>	<del>POLY BAGS</del>	<del>---</del>	<del>NO</del>	
<del>95652-XYH</del>	<del>0.500</del>	<del>12.70</del>	<del>0.070</del>	<del>1.78</del>	<del>0.330</del>	<del>8.38</del>	<del>POLY BAGS</del>	<del>---</del>	<del>NO</del>	
<del>95665-XYH</del>	<del>0.835</del>	<del>21.21</del>	<del>0.335</del>	<del>8.51</del>	<del>0.400</del>	<del>10.16</del>	<del>POLY BAGS</del>	<del>---</del>	<del>NO</del>	
95687-XYH	0.820	20.83	0.360	9.14	0.360	9.14	POLY BAGS	-	NO	
<del>95712-XYH</del>	<del>1.090</del>	<del>27.69</del>	<del>0.110</del>	<del>2.79</del>	<del>0.880</del>	<del>22.35</del>	<del>POLY BAGS</del>	<del>---</del>	<del>NO</del>	
<del>95727-XYH</del>	<del>0.825</del>	<del>20.96</del>	<del>0.110</del>	<del>2.79</del>	<del>0.615</del>	<del>15.62</del>	<del>POLY BAGS</del>	<del>---</del>	<del>NO</del>	
<del>98181-XYH</del>	<del>0.760</del>	<del>19.30</del>	<del>0.218</del>	<del>5.54</del>	<del>0.442</del>	<del>11.23</del>	<del>POLY BAGS</del>	<del>---</del>	<del>NO</del>	
<del>98217-XYH</del>	<del>0.756</del>	<del>19.20</del>	<del>0.328</del>	<del>8.33</del>	<del>0.328</del>	<del>8.33</del>	<del>POLY BAGS</del>	<del>---</del>	<del>NO</del>	
<del>98329-XYH</del>	<del>0.930</del>	<del>23.62</del>	<del>0.415</del>	<del>10.54</del>	<del>0.415</del>	<del>10.54</del>	<del>POLY BAGS</del>	<del>---</del>	<del>NO</del>	
<del>98854-XYH</del>	<del>0.450</del>	<del>11.43</del>	<del>0.120</del>	<del>3.05</del>	<del>0.230</del>	<del>5.84</del>	<del>TUBES</del>	<del>---</del>	<del>NO</del>	
10017852-XYH	0.450	11.43	0.125	3.18	0.225	5.72	POLYBAGS	-	NO	
10074747-XYH	0.850	21.59	0.520	13.21	0.230	5.84	POLYBAGS	-	NO	

FCI  
FCIconnect.com

Copyright FCI

mat'l. code NOTE 2 & 3				surface ISO 1302 <input checked="" type="checkbox"/>		tolerance ISO 406 ISO 1101		projection 		product family BERGSTIK	
ltr	ecn	no	dr	date		tolerances unless otherwise specified		title		BERGSTIK II HEADER D/R	
DH						angles	linear	INCH/MM		.100/2.54cc STRAIGHT	
						0°±2'	.XX±.01/.X±.3 .XXX±0.006/.XXX±.13 .XXXX±0.020/.XXX±.05	scale 2:1		dwg no 67996 sheet 8 of 8 size A3	
						dr	T.BREWBAKER	12/21/94		FCI	
						enr	T.HANNA	12/21/94			
						chr	J.MURPHY	12/21/94			
						appd	T.HANNA	12/21/94		type Product Customer Drawing	
sheet index	revision sheet										



# Mouser Electronics

Authorized Distributor

Click to View Pricing, Inventory, Delivery & Lifecycle Information:

## FCI:

[67996-134](#) [67996-404](#) [67997-106H](#) [67997-124](#) [67997-172H](#) [67997-216](#) [67997-220](#) [67997-272H](#) [67997-372](#)  
[67997-372H](#) [67997-634](#) [67998-114](#) [67998-272](#) [68439-272](#) [68464-120](#) [68481-172H](#) [68491-272](#) [68602-572](#) [68691-110](#) [68691-114](#) [68691-204](#) [68691-272](#) [68738-272H](#) [68799-272](#) [69132-172](#) [69132-172H](#) [69132-472](#) [69133-128](#)  
[78286-272H](#) [79271-372](#) [86834-172](#) [92417-472H](#) [68716-272](#) [68691-414](#) [86837-140HLF](#) [67996-108H](#) [67996-160](#)  
[67996-164H](#) [67996-172H](#) [67996-208H](#) [67996-272H](#) [67996-372H](#) [67996-408H](#) [67996-410H](#) [67996-472H](#) [67996-572H](#) [67996-608H](#) [67996-672H](#) [67997-120H](#) [67997-148](#) [67997-152](#) [67997-170](#) [67997-224H](#) [67997-234](#) [67997-240](#) [67997-406H](#) [67997-416H](#) [67997-446H](#) [67997-472H](#) [67997-526](#) [67997-530H](#) [67997-672H](#) [67998-204](#) [67998-408](#) [67998-414](#) [67998-472](#) [67998-472H](#) [67998-572](#) [67998-600H](#) [67998-672](#) [67998-672H](#) [67999-250](#) [67999-272](#) [67999-472](#) [67999-572](#) [68438-104H](#) [68438-172H](#) [68438-208H](#) [68438-472](#) [68438-472H](#) [68438-572](#) [68439-212H](#) [68439-572](#) [68464-236H](#) [68464-272H](#) [68464-672](#) [68481-114](#) [68481-210H](#) [68481-272](#) [68481-472](#) [68481-672](#) [68491-572](#) [68491-672](#) [68601-126H](#) [68601-572](#) [68601-672](#) [68602-150](#) [68602-416](#) [68690-172](#) [68690-272H](#)