

ACMD-7409

Miniature PCS Band Duplexer

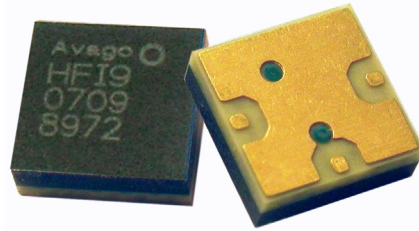

Data Sheet



Description

The Avago ACMD-7409 is a miniature duplexer designed for US PCS handsets.

The ACMD-7409 is designed with Avago Technologies' Film Bulk Acoustic Resonator (FBAR) technology, which makes possible ultra-small, high-Q filters at a fraction of their usual size.

The ACMD-7409 also utilizes Avago's innovative Microcap bonded-wafer, chip scale packaging technology. This process allows the filters to be assembled in a molded chip-on-board module that is less than 1.3 mm high with a footprint of only 3.8 x 3.8 mm.

The ACMD-7409 enhances the sensitivity and dynamic range of PCS receivers by providing more than 54 dB attenuation of the transmitted signal at the receiver input and more than 45 dB rejection of transmit-generated noise in the receive band.

Maximum Insertion Loss in the Tx channel is only 3.5 dB, which minimizes current drain from the power amplifier. Insertion Loss in the Rx channel is 3.8 dB max, improving receiver sensitivity.

The excellent power handling capability of the FBAR bulk-mode resonators supports the high output power levels needed in PCS handsets while adding virtually no distortion.

The ACMD-7409 is an environmentally green version of the ACMD-7402 duplexer.

Features

- Miniature size
 - 3.8 x 3.8 mm footprint size
 - 1.3 mm max height
- High power rating size
 - +33 dBm max Tx power
- Environmental
 - RoHS Compliant
 - Halogen Free
 - TBBPA Free



Specifications

- Performance guaranteed -30 to +85°C
- Rx band performance (1930.5 – 1989.5 MHz) size
 - Insertion loss: 3.8 dB max size
 - Noise blocking: 43 dB min
- Tx band performance (1850.5 – 1909.5 MHz) size
 - Insertion loss: 3.5 dB max size
 - Interferer blocking: 52 dB min

Applications

- Handsets or data terminals operating in the US PCS frequency band

Functional Block Diagram

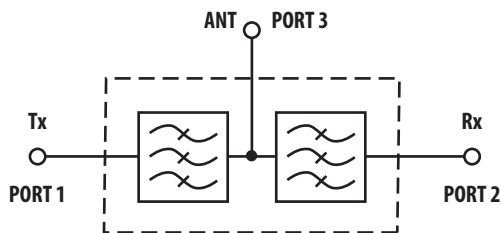

ACMD-7409 Electrical Specifications, $Z_0 = 50 \Omega$, T_c [1,2] as indicated

Symbol	Parameter	Units	- 30°C ^[2]			+25°C ^[2]			+85°C ^[2]		
			Min	Typ ^[3]	Max	Min	Typ ^[3]	Max	Min	Typ ^[3]	Max
Antenna Port to Receive Port											
S23	Insertion Loss in Receive Band (1930.5 – 1989.5 MHz)	dB			3.8		1.5	3.5			3.5
ΔS23	Ripple (p-p) in Receive Band	dB			3.0		1.5	2.6			2.6
S22	Return Loss of Receive Port in Receive Band	dB	9.5			9.5	17		9.5		
S23	Attenuation in Transmit Band (1850.5 – 1909.5 MHz)	dB	52			52	56		52		
S23	Attenuation 0 – 1600 MHz	dB				20	31				
S23	Attenuation in Receive 2 nd Harmonic Band (3861 – 3979 MHz)	dB				18	19				
Transmit Port to Antenna Port											
S31	Insertion Loss in Transmit Band (1850.5 – 1909.5 MHz)	dB			3.0		1.1	3.0			3.5 ^[4]
ΔS31	Ripple (p-p) in Transmit Band	dB			2.3		0.9	2.3			2.8
S11	Return Loss of Transmit Port in Transmit Band	dB	9.5			9.5	20		9.5		
S31	Attenuation in Receive Band (1930.5 – 1989.5 MHz)	dB	43			43	48		43		
S31	Attenuation 0 – 1600 MHz	dB				22	34				
S31	Attenuation in Transmit 2 nd Harmonic Band (3701 – 3819 MHz)	dB				8	13				
Antenna Port											
S33	Return Loss of Antenna Port in Receive Band (1930.5 – 1989.5 MHz)	dB	9			9	16		9		
S33	Return Loss of Antenna Port in Transmit Band (1850.5 – 1909.5 MHz)	dB	9			9	19		9		
Isolation Transmit Port to Receive Port											
S21	Tx-Rx Isolation in Receive Band (1930.5 – 1989.5 MHz)	dB	45			45	48		45		
S21	Tx-Rx Isolation in Transmit Band (1850.5 – 1909.5 MHz)	dB	54			54	58		54		

Notes:

1. T_c is the case temperature and is defined as the temperature of the underside of the Duplexer where it makes contact with the circuit board.
2. Min/Max specifications are guaranteed at the indicated temperature with the input power to the Tx ports equal to or less than +29 dBm over all Tx frequencies unless otherwise noted.
3. Typical data is the average value of the parameter over the indicated band at the specified temperature. Typical values may vary over time. Refer to "Characterization" section for measurement details.
4. At Tx input power between +26 dBm and +29 dBm, the Insertion Loss at the upper edge of the Tx band (1907– 1909.5 MHz) will be slightly degraded. From 1907 to 1909.5 MHz, the maximum Insertion Loss specification at $T_c = +85^\circ\text{C}$ is guaranteed to +26 dBm input power.

Absolute Maximum Ratings^[1]

Parameter	Unit	Value
Storage Temperature	°C	-65 to +125
Maximum RF Input Power to Tx Ports	dBm	+33

Maximum Recommended Operating Conditions^[2]

Parameter	Unit	Value
Operating Temperature, Tc ^[3] , Tx Power 29 dBm	°C	-40 to +100
Operating temperature, Tc ^[3] , Tx Power 30 dBm	°C	-40 to +85

Notes:

1. Operation in excess of any one of these conditions may result in permanent damage to the device.
2. The device will function over the recommended range without degradation in reliability or permanent change in performance, but is not guaranteed to meet electrical specifications.
3. TC is defined as case temperature, the temperature of the underside of the Duplexer where it makes contact with the circuit board.

Characterization

A test circuit similar to that shown in Figure 1 was used to measure typical device performance. This circuit is designed to interface with Air Coplanar (ACP), Ground-Signal-Ground (GSG) RF probes of the type commonly used to test semiconductor wafers.

The test circuit is a 7 x 7 mm PCB with a well-grounded pad to which the device under test (DUT) is solder-mounted.

Short lengths of 50-ohm microstripline connect the DUT to the ACP probe patterns on the board.

A test circuit with a ACMD-7409 mounted in place is shown in Figure 2. S-parameters are then measured using a network analyzer and calibrated ACP probe set.

Phase data for s-parameters measured with ACP probe circuits are adjusted to place the reference plane at the edge of the Duplexer

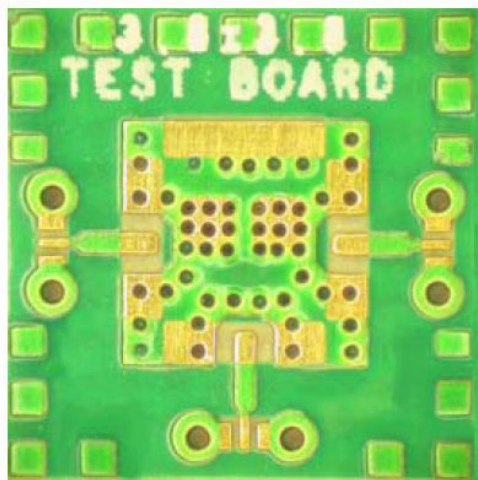

Figure 1. ACP probe test circuit

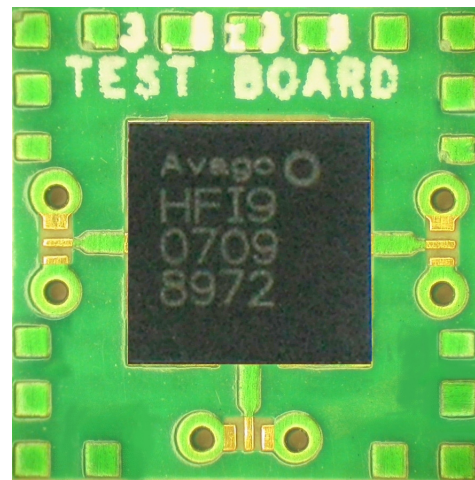

Figure 2. Test circuit with ACMD-7409 duplexer

Typical Performance at Tc = 25°C

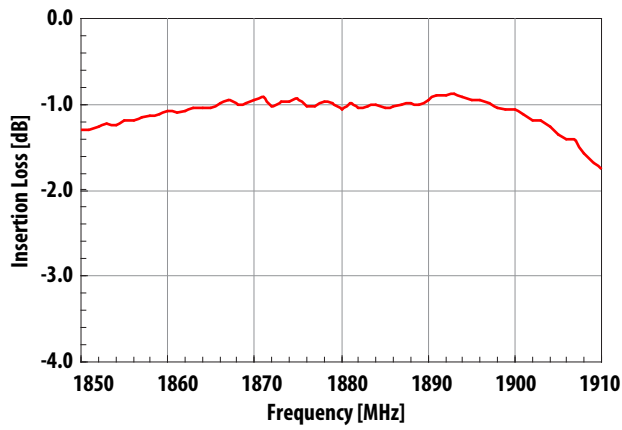

Figure 3. Tx-Ant insertion loss

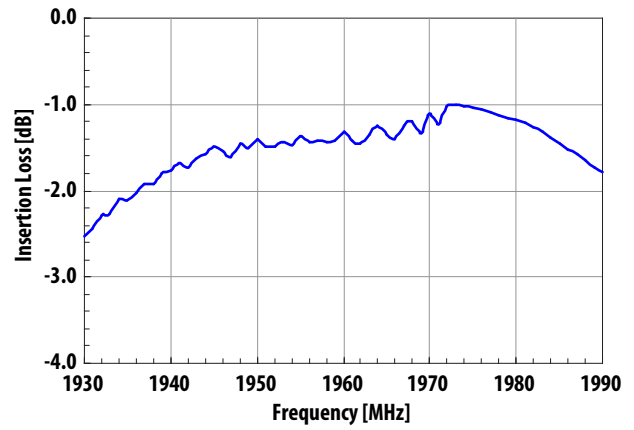

Figure 4. Ant-Rx insertion loss

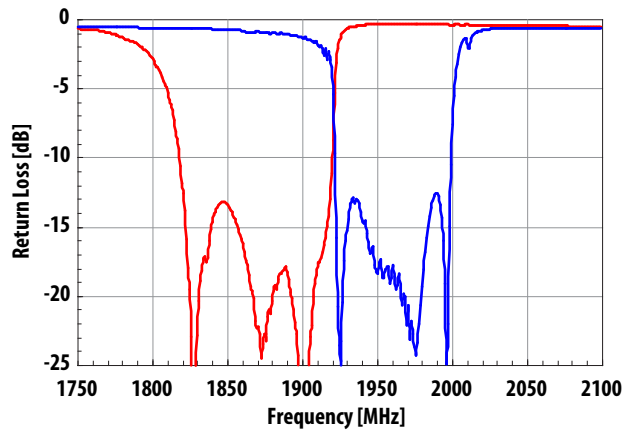

Figure 5. Tx and Rx port return loss

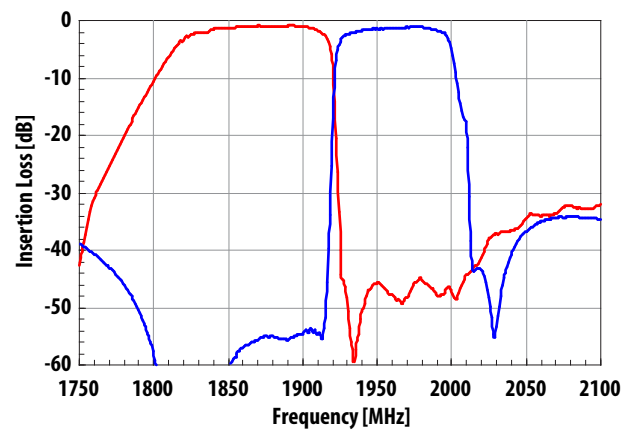

Figure 6. Tx rejection in Rx band and Rx rejection in Tx band

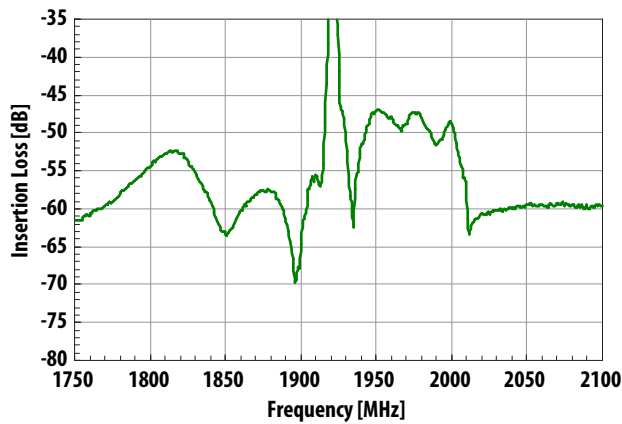

Figure 7. Tx-Rx isolation

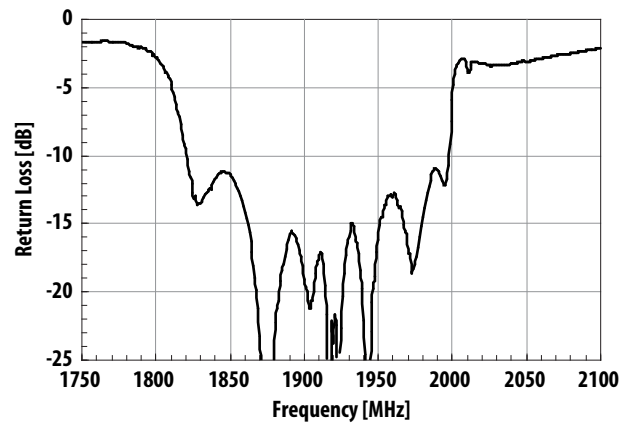

Figure 8. Antenna port return loss

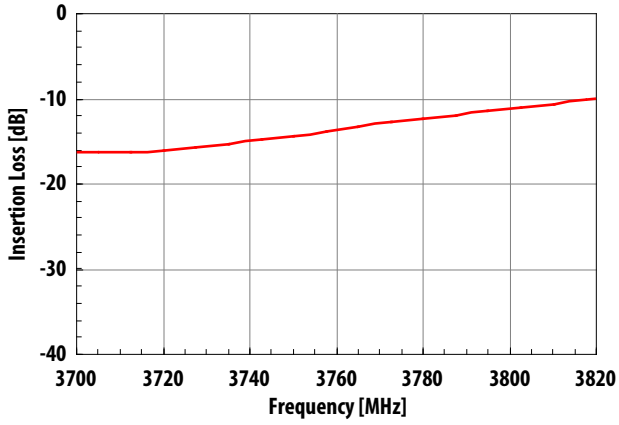

Figure 9. Tx-Ant rejection at Tx second harmonic

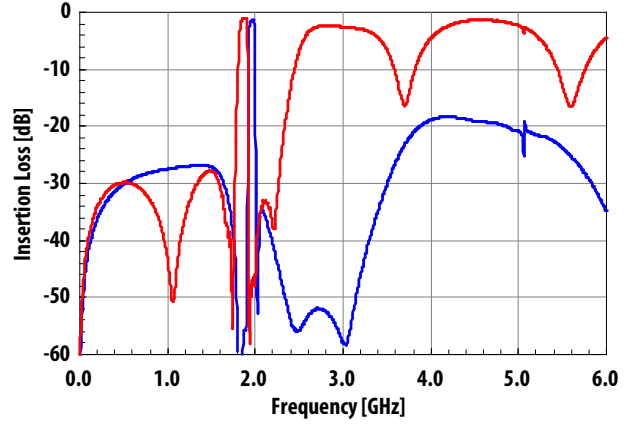

Figure 10. Tx-Ant and Ant-Rx wideband insertion loss

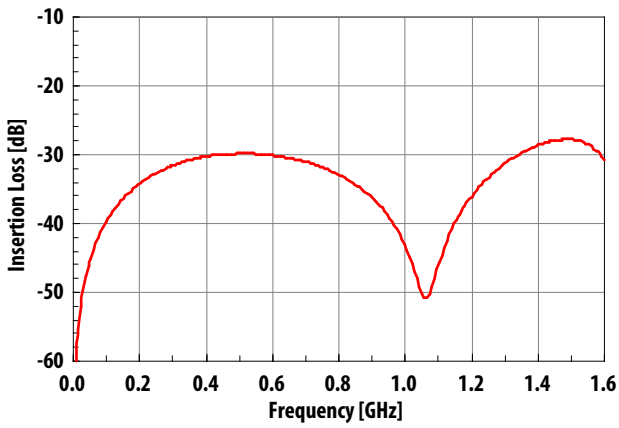

Figure 11. Tx-Ant low frequency rejection

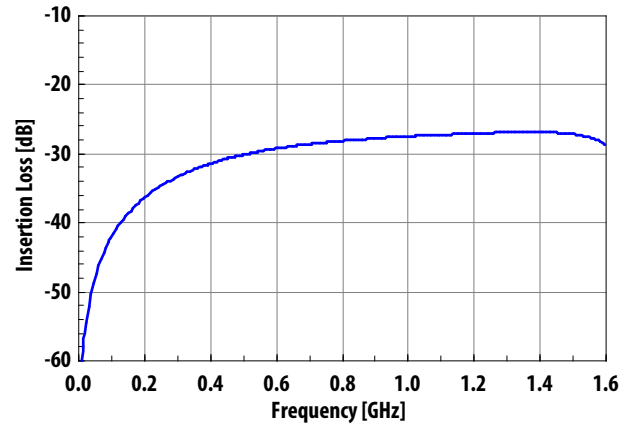
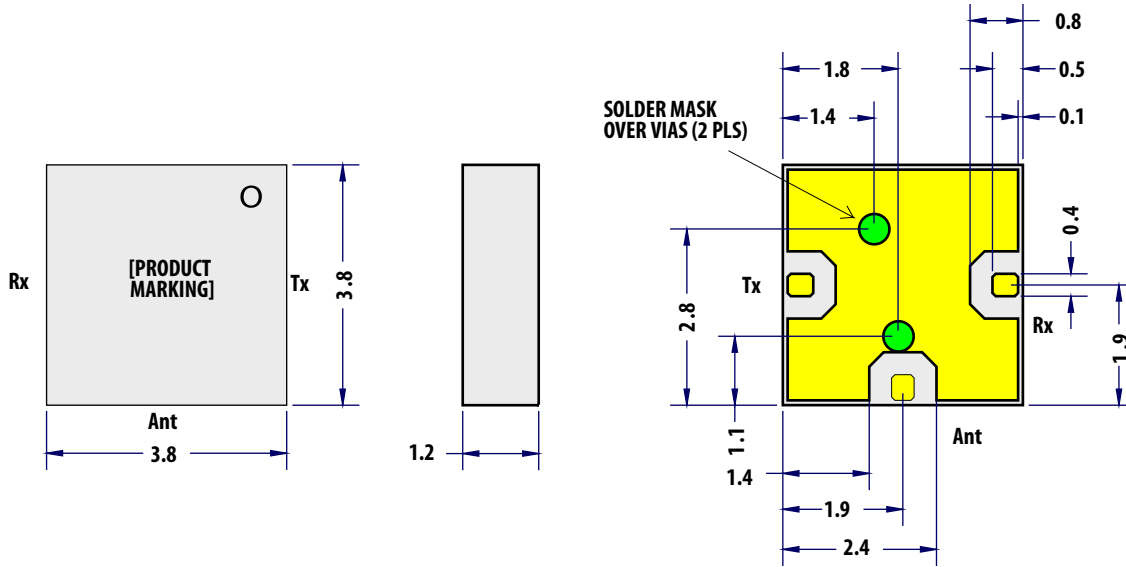

Figure 12. Ant-Rx low frequency rejection



Notes:

1. Dimensions in millimeters
2. Dimensions nominal unless otherwise noted
3. Tolerance:
 $X.X = \pm 0.1$
 $X.XX = \pm 0.05$
4. I/O pads (3 ea), 0.40 x 0.40
5. Contact areas are gold plated
6. Internal vias (2 ea) shown for reference only;
 covered with $\varnothing 0.50$ mm solder mask

Figure 13. Package outline drawing

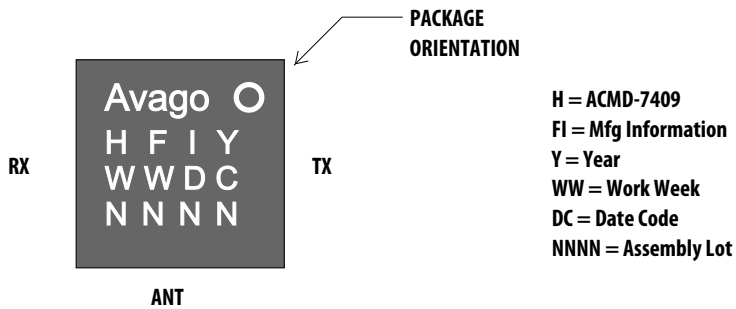

Figure 14. Package marking

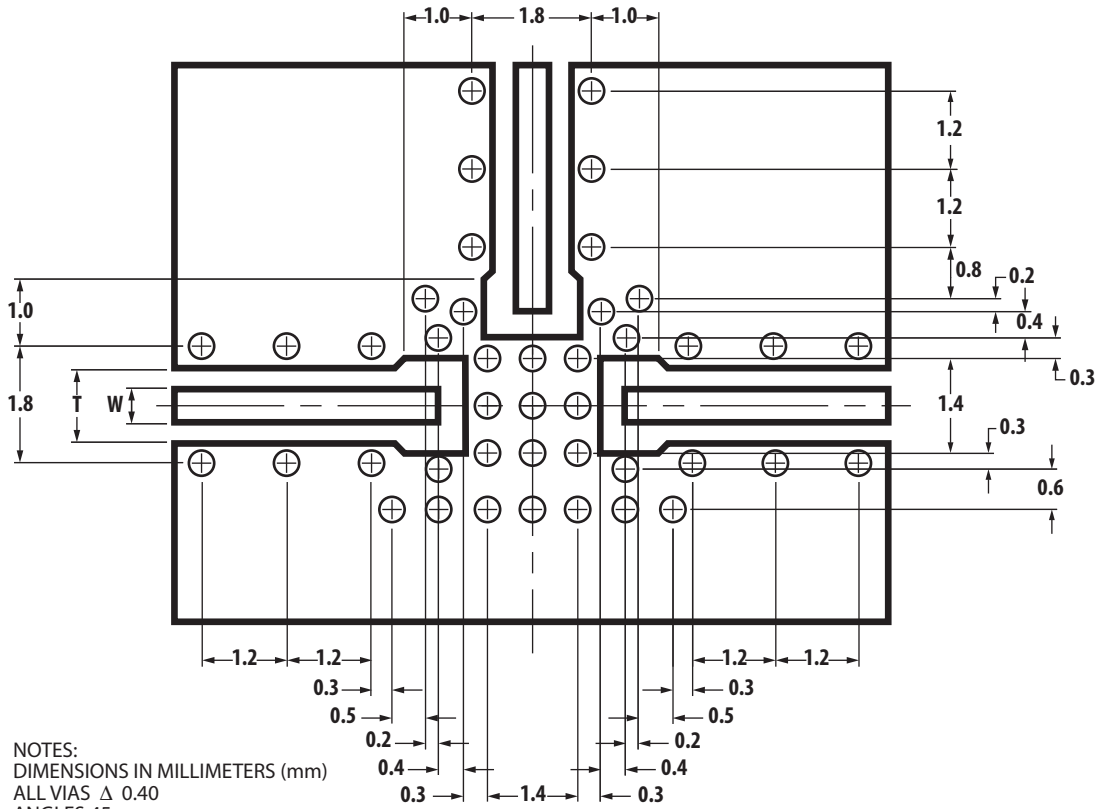

Figure 15. Recommended PCB land print

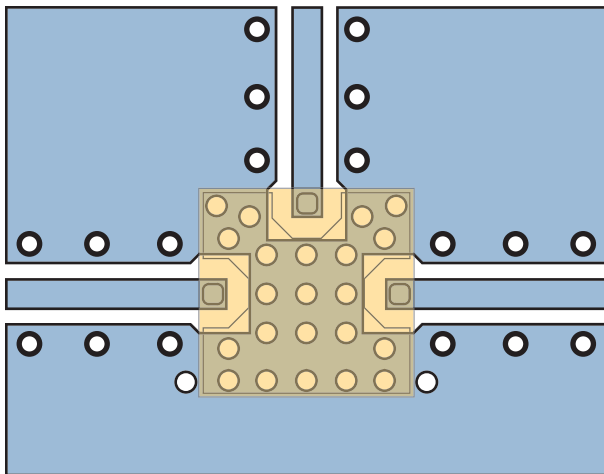
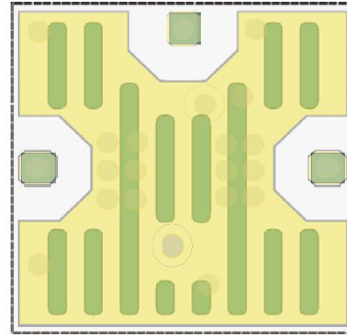
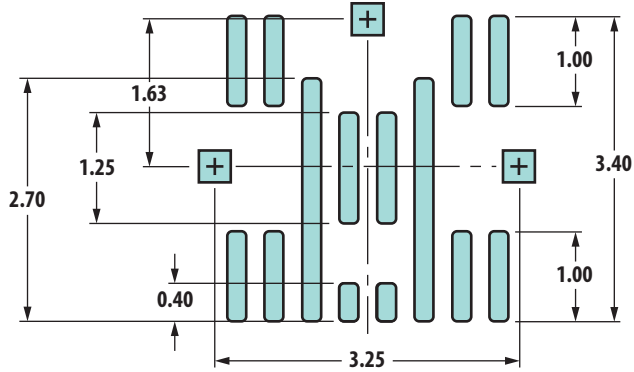

Figure 16. Duplexer superposed on PCB land print



NOTES:

1. DIMENSIONS IN MILLIMETERS (mm).
2. SOLDER STRIPES (14 PLS) ARE 0.20 WIDE, PITCH.
3. SOLDER PADS FOR I/O ARE 0.35 x 0.35.
4. STENCIL PATTERN IS CENTERED ON DUPLEXER.

Figure 17. Recommended solder stencil

Figure 18. Duplexer superposed on solder stencil

Package Moisture Sensitivity

Feature	Test Method	Performance
Moisture Sensivity Level (MSL) at 260°C	J-STD-020C	Level 3

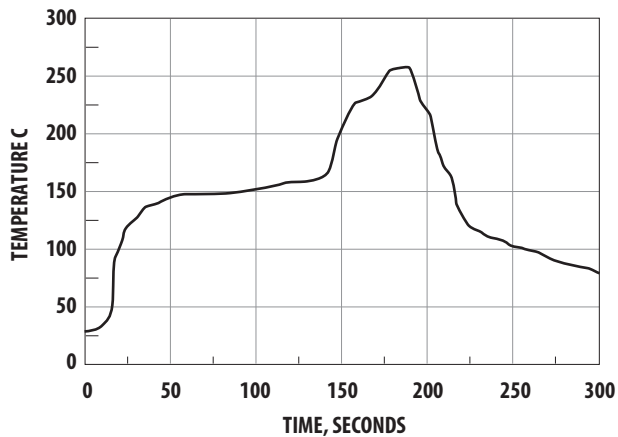

Figure 19. Verified SMT solder profile

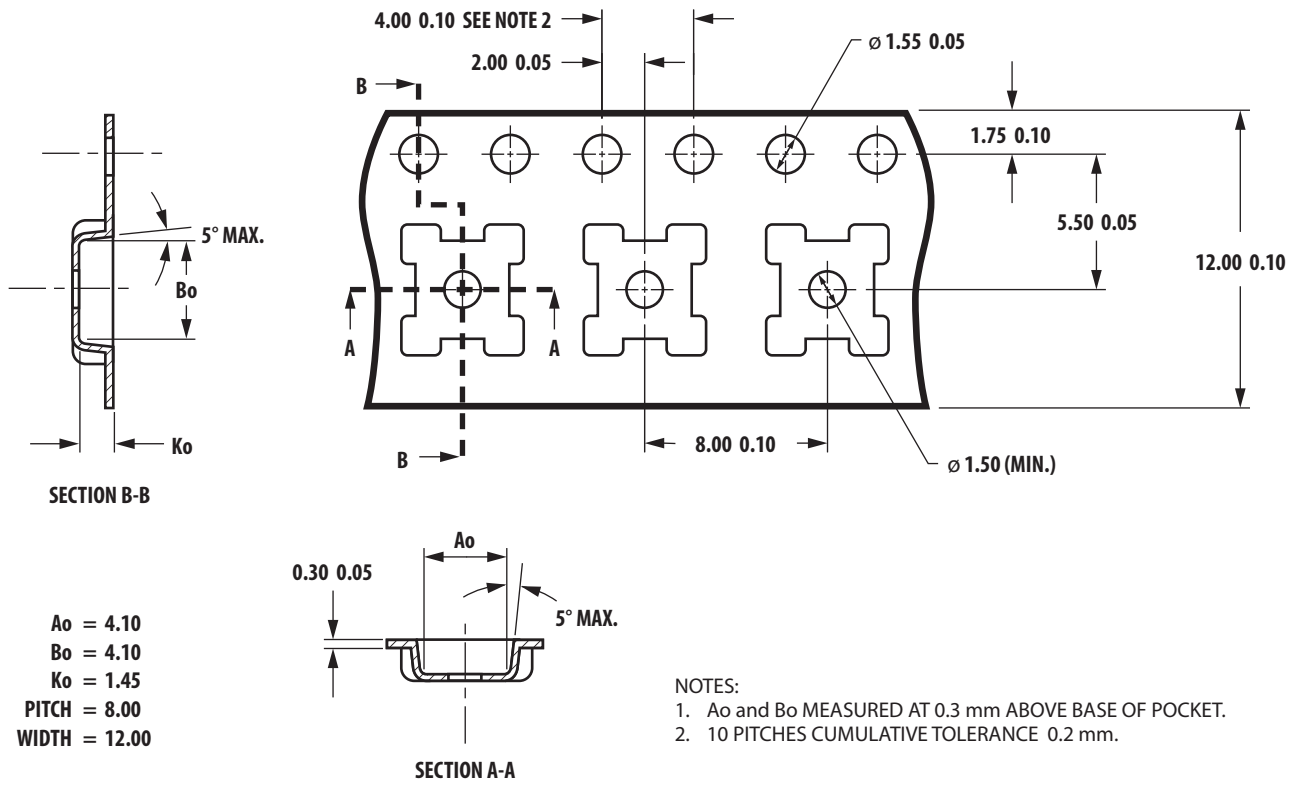

Figure 20. SMD tape packing

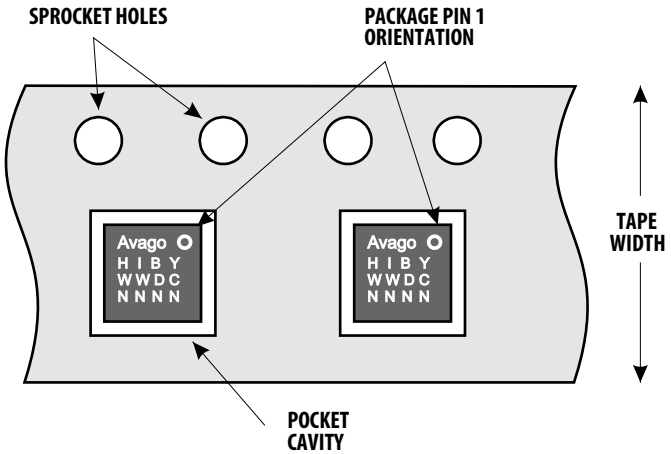

Figure 21. Unit orientation in tape

Ordering Information

Part Number	No. of Devices	Container
ACMD-7409-BLK	25	Anti-static Bag
ACMD-7409-TR1	1000	7-inch Reel

For product information and a complete list of distributors, please go to our web site: www.avagotech.com

Avago, Avago Technologies, and the A logo are trademarks of Avago Technologies in the United States and other countries.
Data subject to change. Copyright © 2005-2009 Avago Technologies. All rights reserved.
AV02-1824EN - March 24, 2009

AVAGO
TECHNOLOGIES