

**PLEASE CHECK WWW.MOLEX.COM FOR LATEST PART INFORMATION**

**Part Number:** [0622021950](#)  
**Status:** **Active**  
**Overview:** [Application Tooling](#)  
**Description:** Modular Press-In Tool, 40 Circuits

**Documents:**

[RoHS Certificate of Compliance \(PDF\)](#)

**General**

Product Family	Application Tooling
Series	<a href="#">207122</a>
Function	Insertion
Geographic Area	Global
Level of Automation	Manual
More Detailed Tech Information	<a href="mailto:applicationtooling@molex.com">applicationtooling@molex.com</a>
Overview	<a href="#">Application Tooling</a>
Product Name	N/A
Tool Type	Press-Fit Insertion Tool
UPC	822348147991
Warranty Disclaimer	CAUTION: Molex tooling crimp specifications are valid only when used with Molex terminals and tooling manufactured by Molex and sold by Molex or authorized distributors ("Molex Tooling"). When using tooling other than Molex Tooling with Molex specific connector systems listed in our ATS documents, the Molex tooling qualification does not apply and the responsibility for full qualification of the connector system is that of the customer. Molex accepts no liability for connector performance or tooling support where tooling other than Molex Tooling is used or where Molex Tooling is modified.

**Material Info**

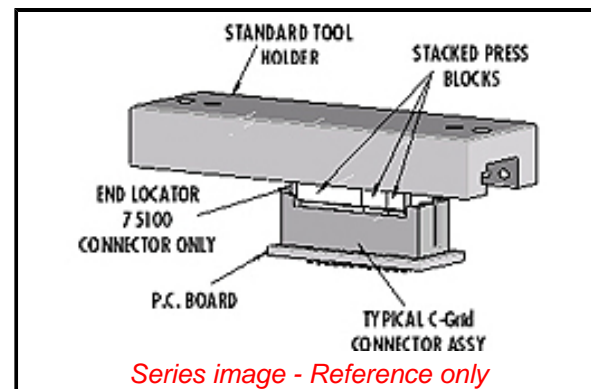

**EU ELV**

**Not Reviewed**

**EU RoHS**

**Not Reviewed**

**REACH SVHC**

Not Reviewed

**Halogen-Free**

**Status**

**Not Reviewed**

For more information, please visit [Contact US](#)

China ROHS

Not Reviewed

ELV

Not Reviewed

RoHS Phthalates

Not Reviewed

**Search Parts in this Series**

[207122 Series](#)