

ACPL-214

AC Input, Half-Pitch Phototransistor Optocoupler



Data Sheet



Description

The ACPL-214 is an AC-input single channel half-pitch phototransistor optocoupler which contains 2 light emitting diodes connected inversely parallel & optically coupled to a phototransistor. It is packaged in a 4-pin SO package.

The input-output isolation voltage is rated at 3000 Vrms. Response time, t_r , is $2\mu s$ typically, while minimum CTR is 20% at input current of 5 mA

ACPL-214 pin layout

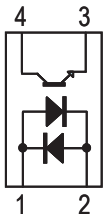

- Pin 1 Anode
- Pin 2 Cathode
- Pin 3 Emitter
- Pin 4 Collector

Features

- Current transfer ratio (CTR: 20% (min) at $I_F = \pm 5mA$, $V_{CC} = 5V$)
- High input-output isolation voltage ($V_{ISO} = 3,000V_{RMS}$)
- Non-saturated Response time (t_r : $2\mu s$ (typ) at $V_{CC} = 10V$, $I_C = 2mA$, $R_L = 100\Omega$)
- SO package
- CMR $10kV/\mu s$ (typical)
- Safety and regulatory approvals
 - UL
 - CSA
 - IEC/EN/DIN EN 60747-5-2
- Options available:
 - CTR Ranks 0, A

Applications

- I/O Interface for Programmable controllers, computers.
- Sequence controllers
- System appliances, measuring instruments
- Signal transmission between circuits of different potentials and impedances.

Ordering Information

ACPL-214-xxxx is pending UL Recognition with 3000 Vrms for 1 minute per UL1577 and is pending approval under CSA Component Acceptance Notice #5, File CA 88324.

Part number	RoHS Compliant Option		Package	Surface Mount	Tape & Reel	IC Orientation	IEC/EN/DIN EN 60747-5-2	Quantity
	Rank '0'	Rank 'A'						
	20%<CTR<400% I _F =±5mA V _{CE} =5V	50%<CTR<150% I _F =±5mA V _{CE} =5V						
ACPL-214	-500E	-50AE	SO-4	x	X	0°		3000 pcs per reel
	-560E	-56AE	SO-4	x	X	0°	X	3000 pcs per reel
	-700E	-70AE	SO-4	x	X	180°		3000 pcs per reel
	-760E	-76AE	SO-4	x	X	180°	X	3000 pcs per reel

"To order, choose a part number from the part number column and combine with the desired option from the option column to form an order entry.

Example 1:

HCPL-214-560E to order product of SO-4 Surface Mount package in Tape & Reel packaging with IEC/EN/DIN EN 60767-5-2 Safety Approval, 20%<CTR<400% and RoHS compliant.

Example 2:

ACPL-214-50AE to order product of SO-4 Surface Mount package in Tape & Reel packaging with 50%<CTR<150% and RoHS compliant.

Option datasheets are available. Contact your Avago sales representative or authorized distributor for information.

Package Outline Drawings

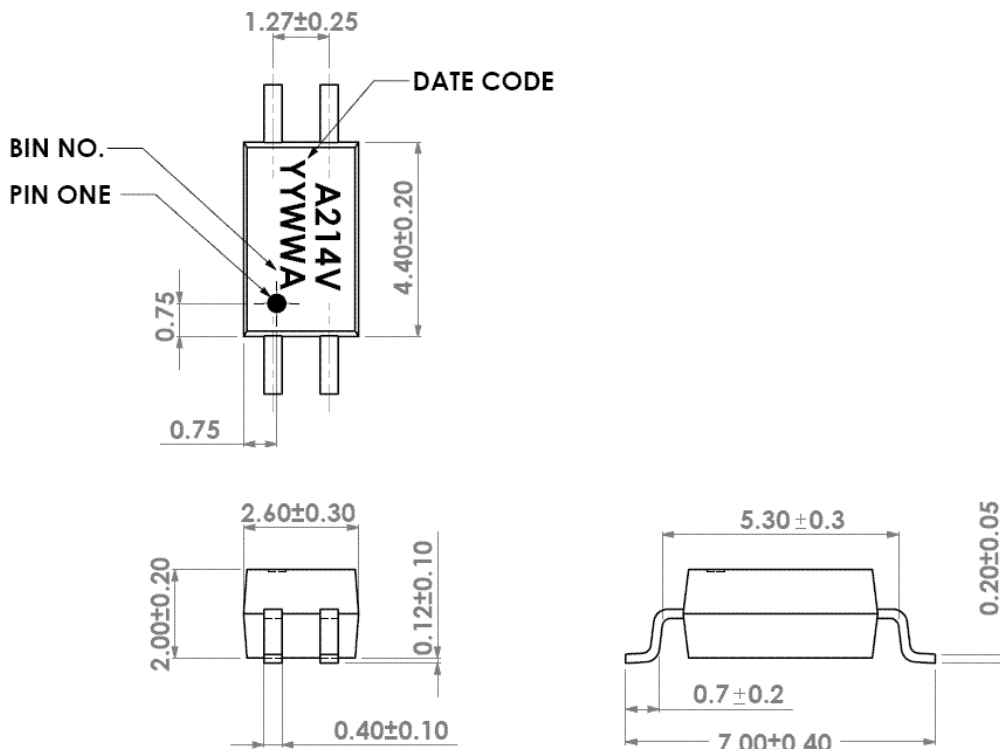

Solder Reflow Temperature Profile

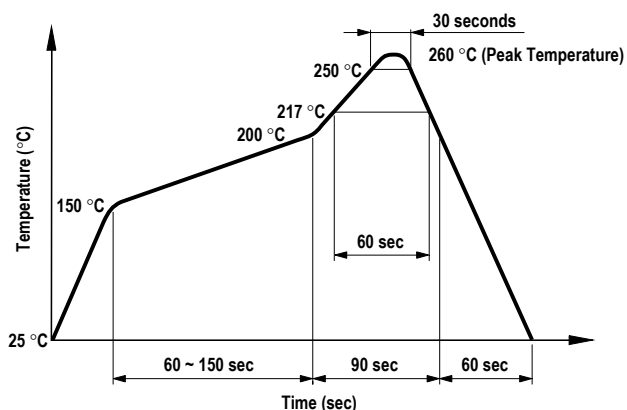

1. One-time soldering reflow is recommended within the condition of temperature and time profile shown at right.
2. When using another soldering method such as infrared ray lamp, the temperature may rise partially in the mold of the device. Keep the temperature on the package of the device within the condition of (1) above.

Note: Non halide flux should be used.

Absolute Maximum Ratings

Parameter	Symbol	ACPL-214	Units	Note
Storage Temperature	T_S	-55~125	°C	
Operating Temperature	T_A	-55~110	°C	
Average Forward Current	$I_{F(AVG)}$	±50	mA	
Pulse Forward Current	I_{FSM}	±1	A	
LED Power Dissipation	P_I	65	mW	
Collector Current	I_C	50	mA	
Collector-Emitter Voltage	V_{CEO}	80	V	
Emitter-Collector Voltage	V_{ECO}	7	V	
Isolation Voltage (AC for 1min, R.H. 40~60%)	V_{ISO}	3000	V_{RMS}	1min
Collector Power Dissipation	P_C	150	mW	
Total Power Dissipation	P_{TOT}	200	mW	
Lead Solder Temperature		260°C for 10 sec., 1.6 mm below seating plane		

Electrical Specifications

Over recommended ambient temperature at 25°C unless otherwise specified.

Parameter	Symbol	Min.	Typ.	Max.	Units	Test Conditions	Note
Forward Voltage	V_F	-	1.2	1.4	V	$I_F = \pm 20\text{mA}$	Fig.6
Terminal Capacitance	C_t	-	60	-	pF	$V = 0, f = 1\text{MHz}$	
Collector Dark Current	I_{CEO}	-	-	100	nA	$V_{CE} = 48\text{V}, I_F = 0\text{mA}$	Fig.12
Collector-Emitter Breakdown Voltage	BV_{CEO}	80	-	-	V	$I_C = 0.5\text{mA}, I_F = 0\text{mA}$	
Emitter-Collector Breakdown Voltage	BV_{ECO}	7	-	-	V	$I_E = 100\ \mu\text{A}, I_F = 0\text{mA}$	
Current Transfer Ratio	CTR	20	-	400	%	$I_F = \pm 5\text{mA}, V_{CE} = 5\text{V}$	$\text{CTR} = (I_C/I_F) \times 100\%$
Saturated CTR	$\text{CTR}_{(\text{sat})}$	-	100	-	%	$I_F = \pm 1\text{mA}, V_{CE} = 0.4\text{V}$	
Collector-Emitter Saturation Voltage	$V_{CE(\text{sat})}$	-	-	0.4	V	$I_F = \pm 8\text{mA}, I_C = 2.4\text{mA}$	Fig.14
Isolation Resistance	Riso	5×10^{10}	1×10^{11}	-	Ω	DC500V, R.H. 40~60%	
Floating Capacitance	C_F	-	0.8	1	pF	$V = 0, f = 1\text{MHz}$	
Cut-off Frequency (-3dB)	F_C	-	80	-	kHz	$V_{CC} = 5\text{V}, I_C = 2\text{mA}, R_L = 100\Omega$	Fig. 2,19
Response Time (Rise)	t_r	-	2	-	μs	$V_{CC} = 10\text{V}, I_C = 2\text{mA}, R_L = 100\Omega$	Fig. 1
Response Time (Fall)	t_f	-	3	-	μs		
Turn-on Time	t_{on}	-	3	-	μs		
Turn-off Time	t_{off}	-	3	-	μs		
Turn-ON Time	t_{ON}	-	2	-	μs	$V_{CC} = 5\text{V}, I_F = 16\text{mA}, R_L = 1.9\text{k}\Omega$	Fig. 1, 17
Storage Time	T_S	-	25	-	μs		
Turn-OFF Time	t_{OFF}	-	40	-	μs		
Common Mode Rejection Voltage	CMR	-	10	-	$\text{kV}/\mu\text{s}$	$T_a = 25^\circ\text{C}, R_L = 470\Omega, V_{CM} = 1.5\text{kV}(\text{peak}), I_F = 0\text{mA}, V_{CC} = 9\text{V}, V_{np} = 100\text{mV}$	Fig.20

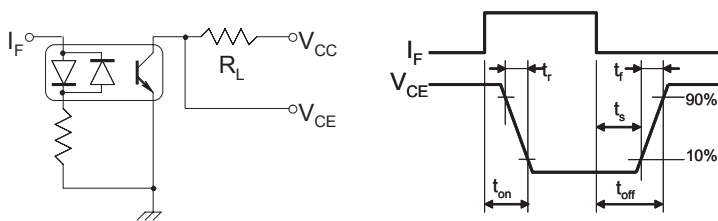

Figure 1. Switching Time Test Circuit

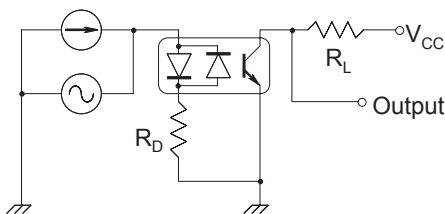

Figure 2. Frequency Response Test Circuit

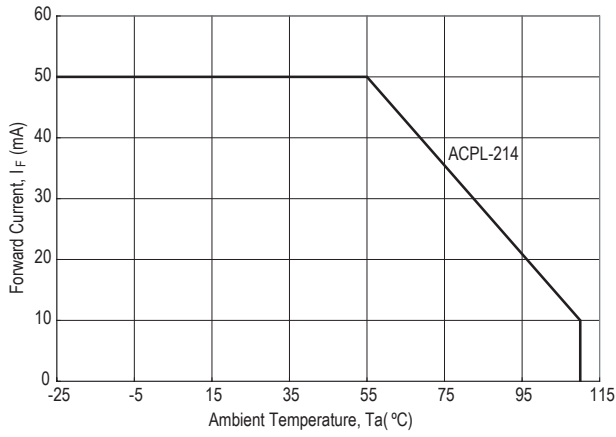

Figure 3. Forward Current vs. Ambient Temperature

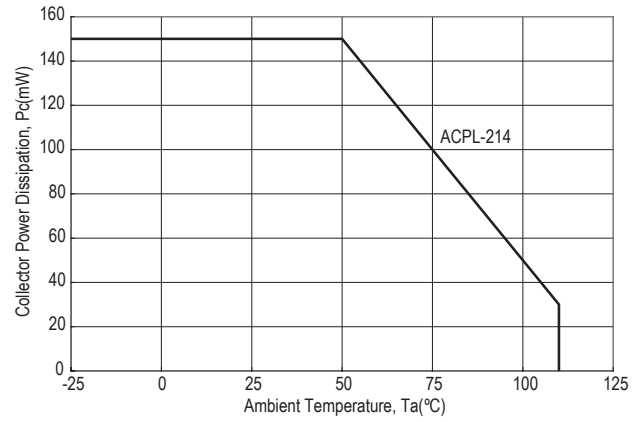

Figure 4. Collector Power Dissipation vs. Ambient Temperature

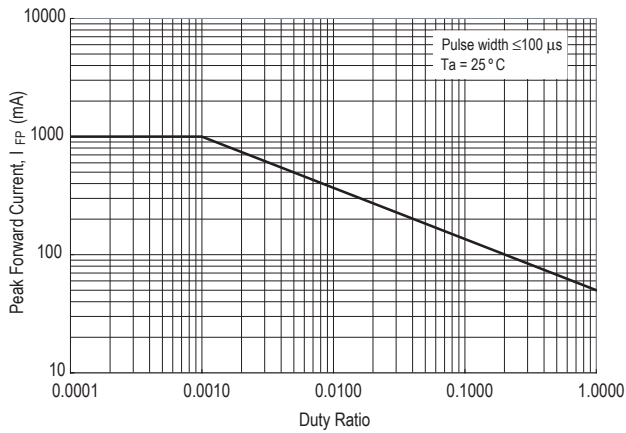

Figure 5. Pulse Forward Current vs. Duty Cycle Ratio

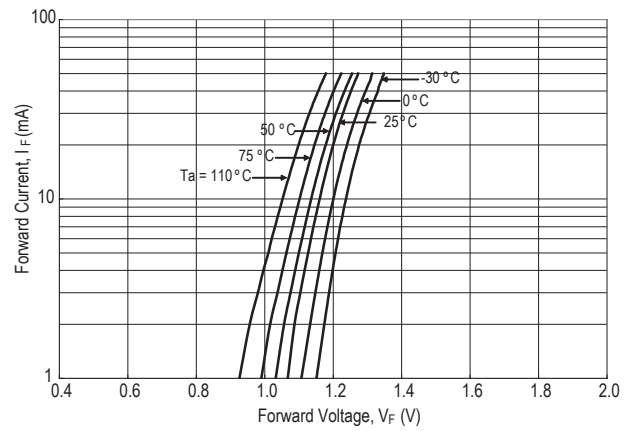

Figure 6. Forward Current vs. Forward Voltage

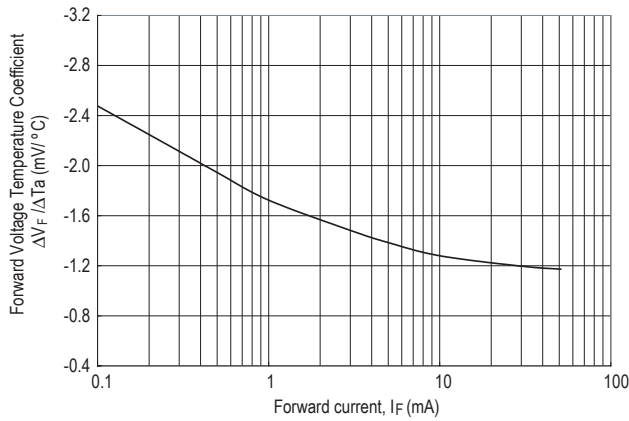

Figure 7. Forward Voltage Temperature Coefficient vs. Forward Current

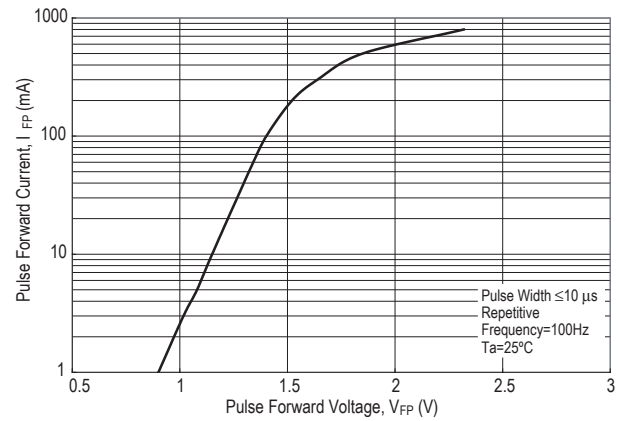

Figure 8. Pulse Forward Current vs. Pulse Forward Voltage

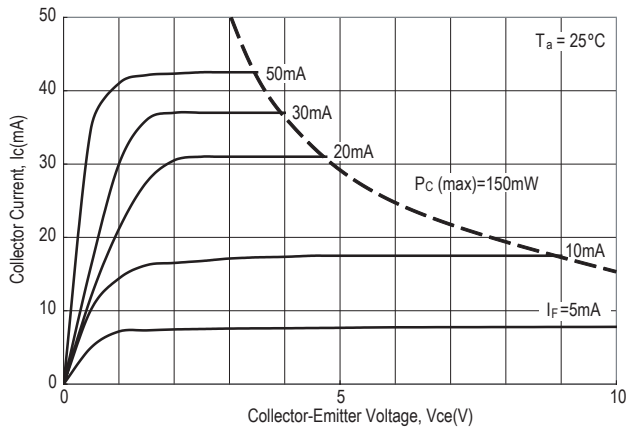

Figure 9. Collector Current vs. Collector-Emitter Voltage

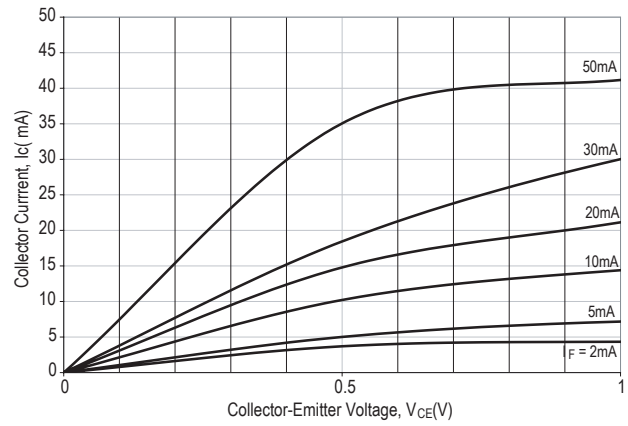

Figure 10. Collector Current vs. Small Collector-Emitter Voltage

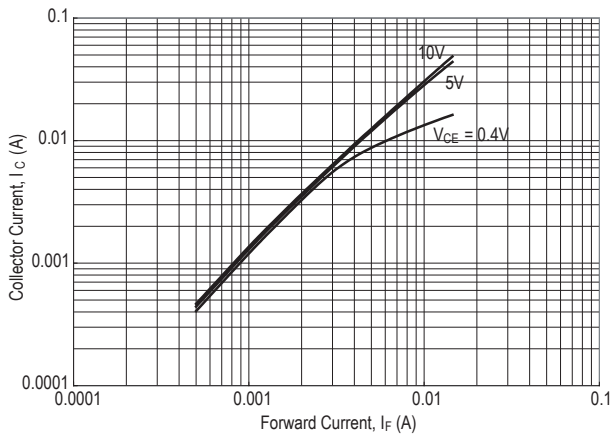

Figure 11. Collector Current vs. Forward Current

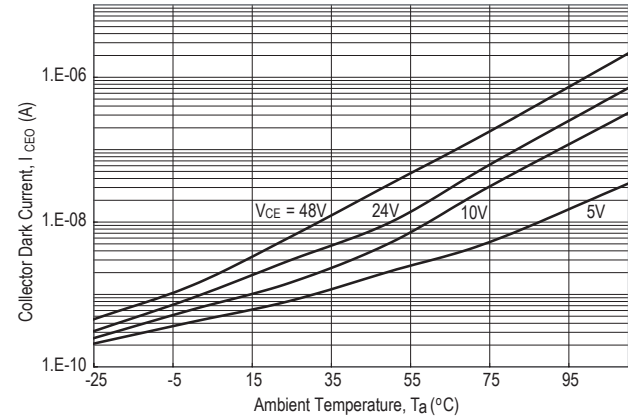

Figure 12. Collector Dark Current vs. Ambient Temperature

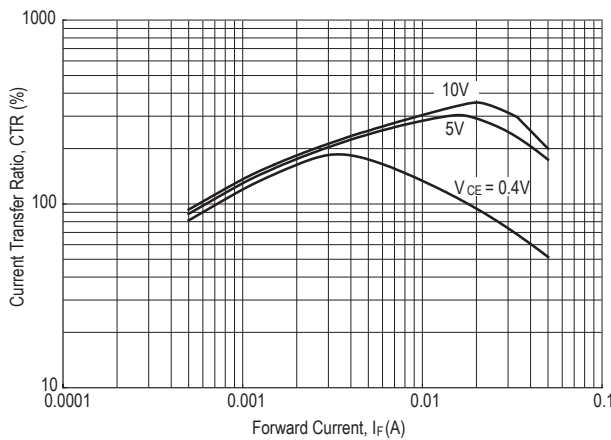

Figure 13. Current Transfer Ratio vs. Forward Current

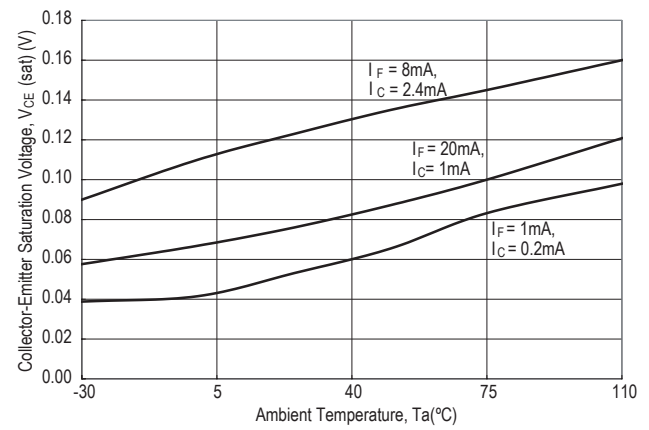

Figure 14. Collector-Emitter Saturation Voltage vs. Ambient Temperature

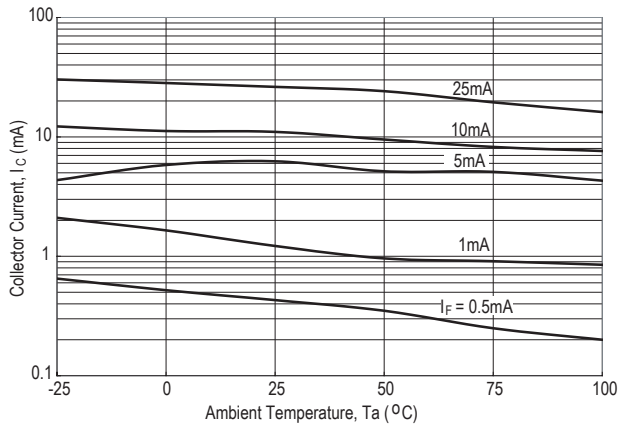

Figure 15. Collector Current vs. Ambient Temperature

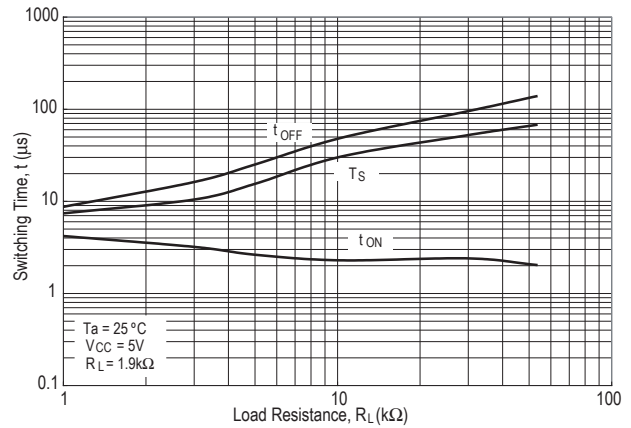

Figure 16. Switching Time vs. Load Resistance

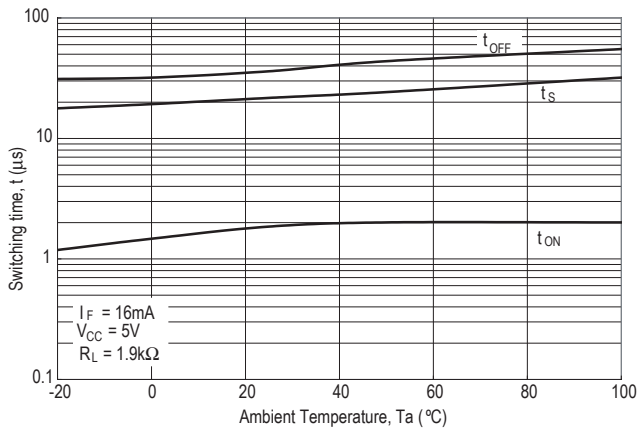

Figure 17. Switching Time vs. Ambient Temperature

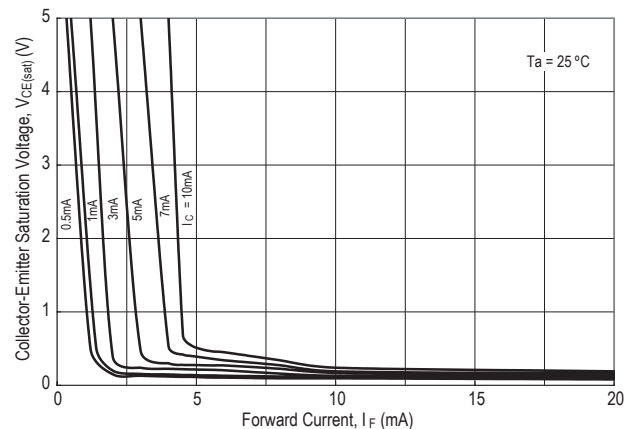

Figure 18. Collector-Emitter Saturation Voltage vs. Forward Current

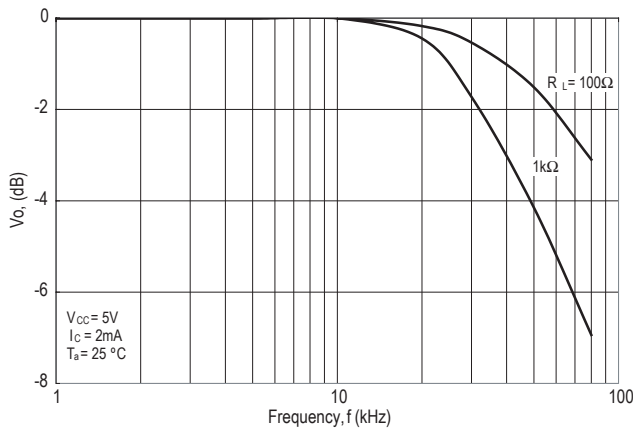

Figure 19. Frequency Response

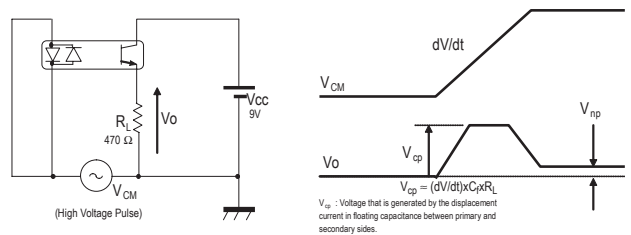

Figure 20. CMR Test Circuit

For product information and a complete list of distributors, please go to our web site: www.avagotech.com

Avago, Avago Technologies, and the A logo are trademarks of Avago Technologies Limited in the United States and other countries. Data subject to change. Copyright © 2008 Avago Technologies Limited. All rights reserved. AV02-0469EN - February 26, 2008