

# Accutek Microcircuit Corporation

## 4 Pin to 14 Pin DIP Adapters

# DIP ADAPTER MODULES ELIMINATE THE NEED TO REDESIGN MOTHERBOARDS OR MAY BE USED FOR BREADBOARD PROTOTYPING

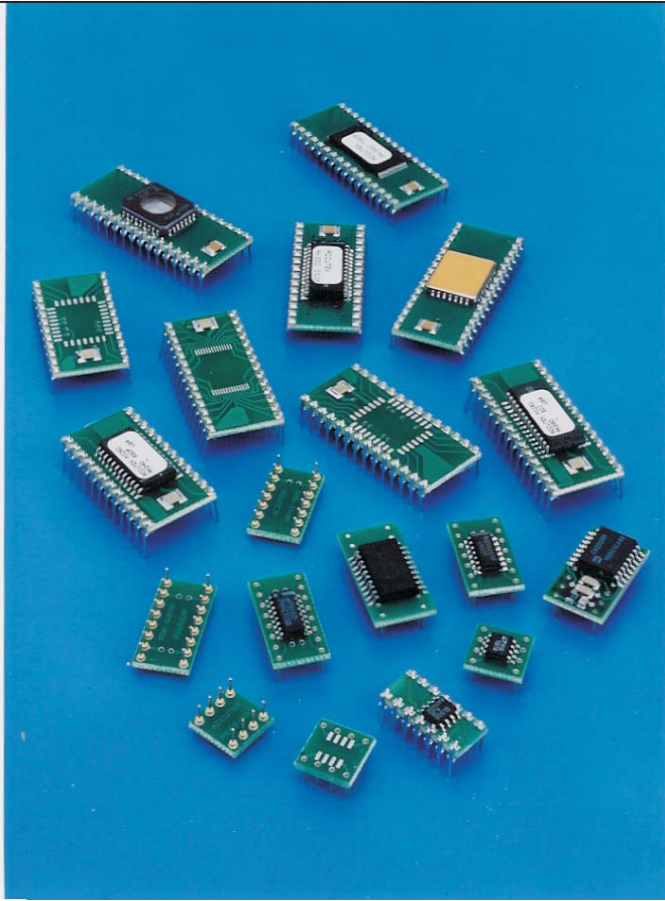

This new family of Accutek DIP Adapter Modules converts surface mount IC's to pin compatible DIP packages for creating drop-in replacements for end-of-life DIP IC's. Package types supported are: SOJ, PLCC, SOIC, SOP, TSOP, QSOP, HSOP, MSOP, LLP (Leadless Leadframe Package), CSP (Chip Scale Package) and CLCC.

These DIP Adapters were developed for users with motherboard designs that require DIP's, now obsolete by manufacturers. These adapter modules save costly motherboard redesigns.

Available with machined or flat contact pins. Accutek DIP Adapter Modules feature 4 to 84 pins, are fully assembled and tested and may include a decoupling capacitor. These DIP Adapters can be manufactured turnkey or from customer supplied surface mount chips. Modules range in length from 0.200" to 4.200" depending on number of pins and incorporate 0.300", 0.400", 0.600", 0.900", 1.200" and 1.400" row-to-row spacing with 0.100" lead spacing.

Custom configurations up to 200 pins, multi-chip and double sided modules are also available for special functions. A variety of pin lengths with varying diameters as well as custom sizes and spacing can be specified with different materials and finishes. All modules are designed in-house using PCB CAD workstations. Automated assembly and 100% testing are also performed in-house.

### FEATURES

- Saves costly redesign of current motherboards
- Fully tested with lifetime limited warranty
- May include an on board decoupling capacitor
- IC assembly and testing available
- EPROM and Flash programming available
- Custom lead lengths available
- Custom multi-chip and double-sided modules available

### ORDERING OPTIONS

- Adapter only
- Customer supplies chips - Accutek assembles on Accutek adapters, tests and delivers finished product in antistatic tubes.
- Complete turnkey - Accutek purchases IC's and passives. Then assembles, tests and delivers finished product in antistatic tubes.



#### ACCUTEK MICROCIRCUIT CORPORATION

BUSINESS CENTER at NEWBURYPORT  
2 NEW PASTURE ROAD, SUITE 1  
NEWBURYPORT, MA 01950-4054

PHONE: 978-465-6200 FAX: 978-462-3396  
E-Mail: sales@accutekmicro.com  
Internet: www.accutekmicro.com

**AK04D300-SOT**  
4 PIN SOT TO DIP

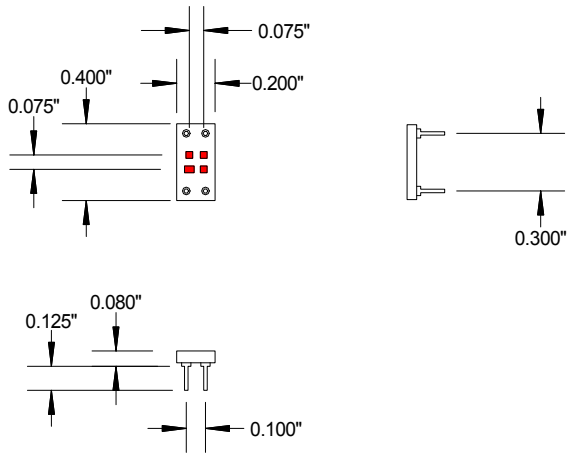

**AK06D300-SOT**  
6 PIN SOT TO DIP

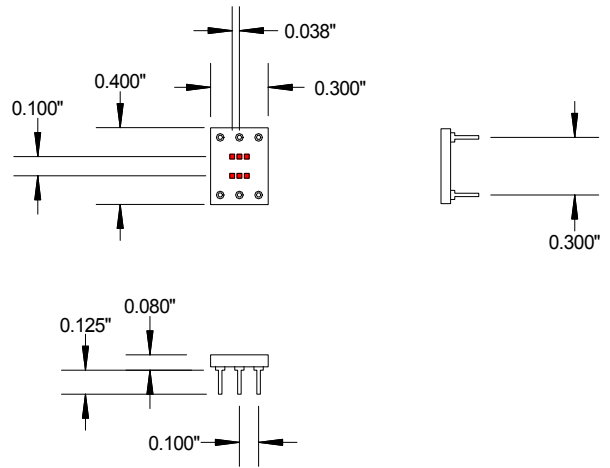

**AK06D300-QSOP**  
6 PIN QSOP TO DIP

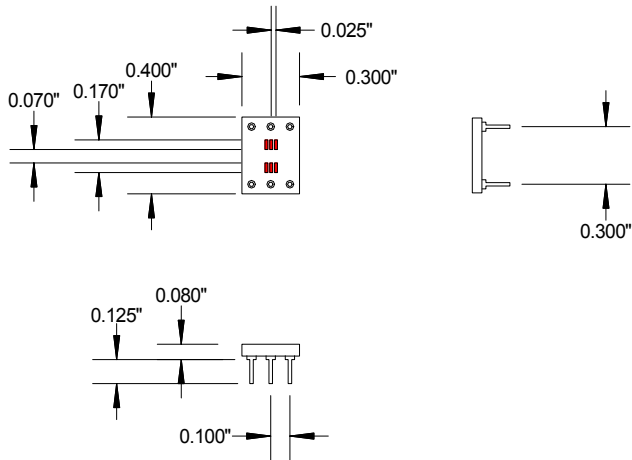

**AK08D300-SOT**  
8 PIN SOT TO DIP

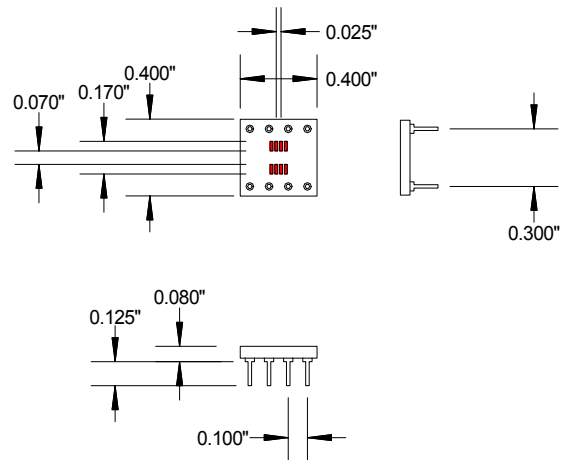

**AK08D300-QSOP**  
8 PIN QSOP & SSOP TO DIP

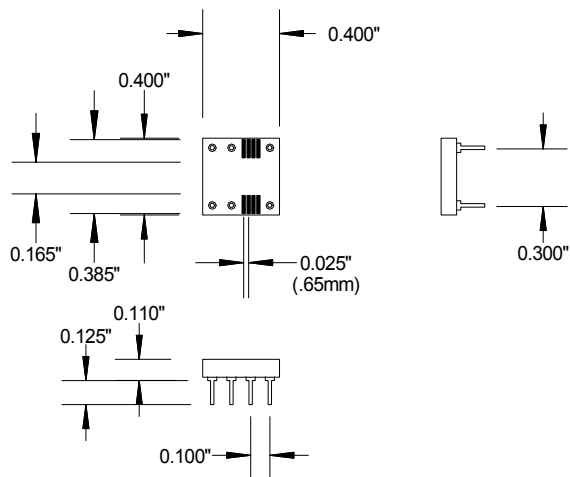

**AK08D300-TSOP**  
8 PIN TSOP & SSOP TO DIP

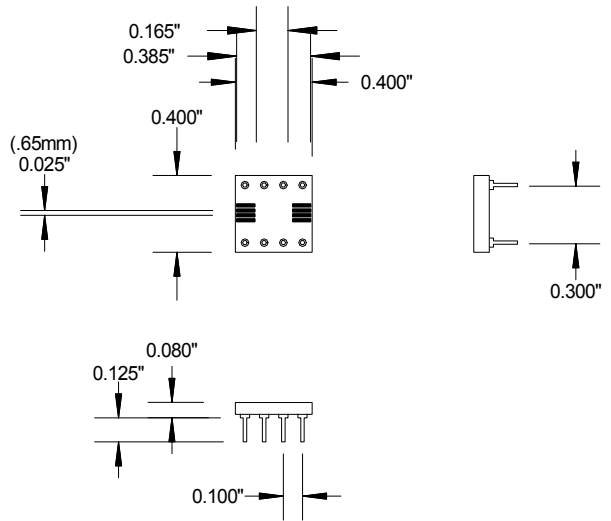

### AK08D300-MSOP.65

8 PIN .65MM PITCH MSOP(micro-soic) TO DIP

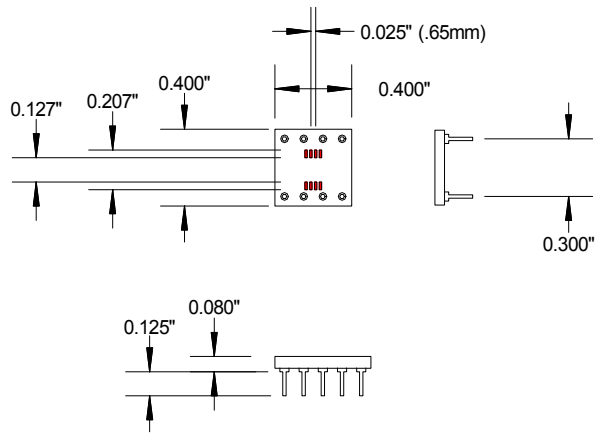

### AK08D300-MSOP.5

8 PIN .5MM PITCH MSOP(micro-soic) TO DIP

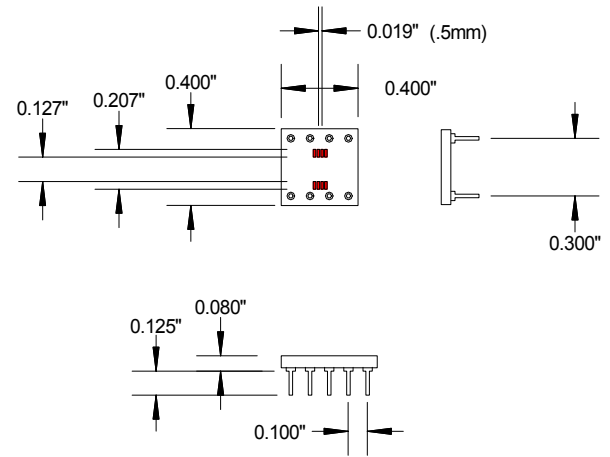

### AK08D-LLP3X3

LEADLESS LEADFRAME PACKAGE (3 X 3)  
TO 8 PIN DIP

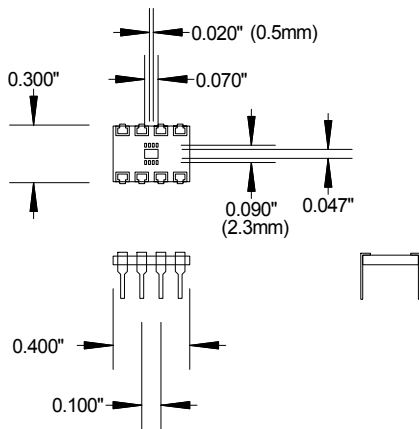

### AK08D-LLP4X4

LEADLESS LEADFRAME PACKAGE (4 X 4)  
TO 8 PIN DIP

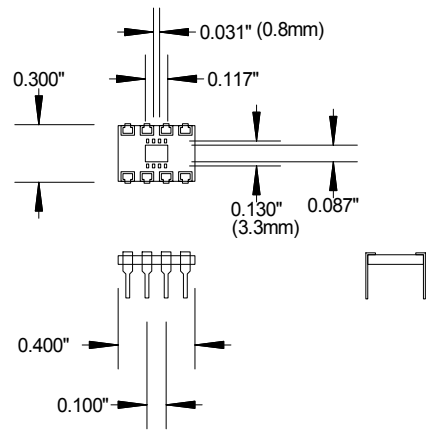

### AK08D300-NSO

8 PIN SOIC TO DIP

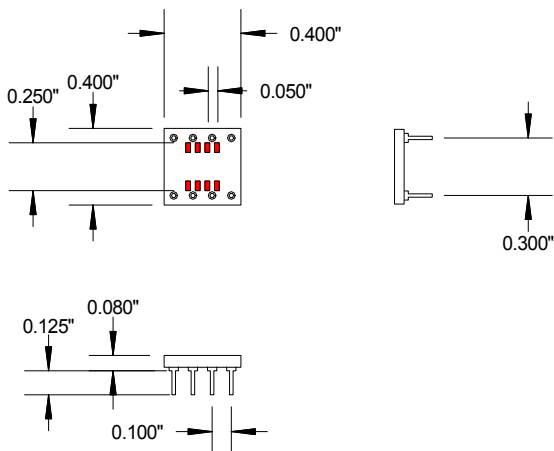

### AK08D300-CLCC

8 PIN CLCC TO DIP  
(CLCC=ceramic leadless chip carrier)

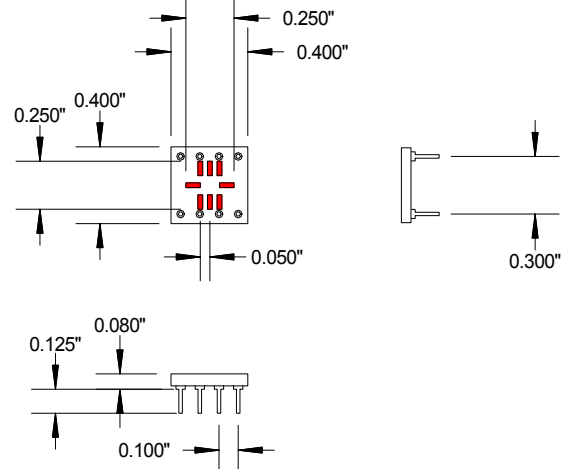

### AK08D300-HSOP

8 PIN HSOP TO DIP

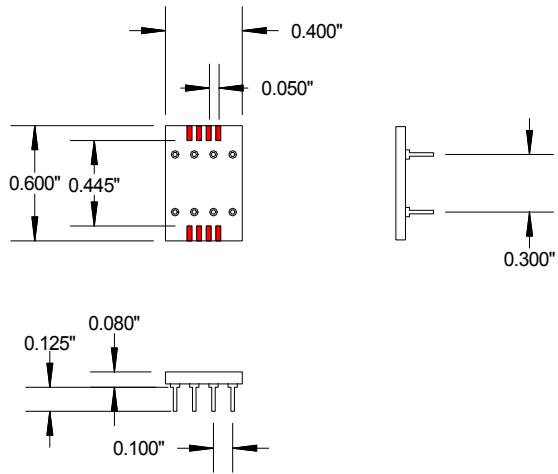

### AK08DS300-SOSPA

8 PIN PROGRAMMING ADAPTER  
FOR EEPROM SOIC ADAPTER  
SOCKET AK08SOIC-ST

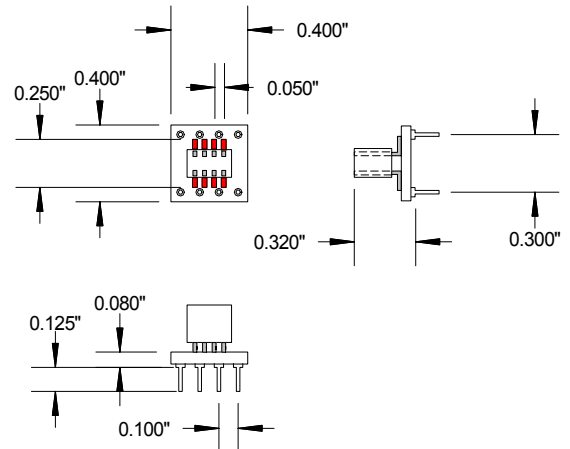

### AK10D-LLP3X3

LEADLESS LEADFRAME PACKAGE(3X3)  
TO 10 PIN DIP

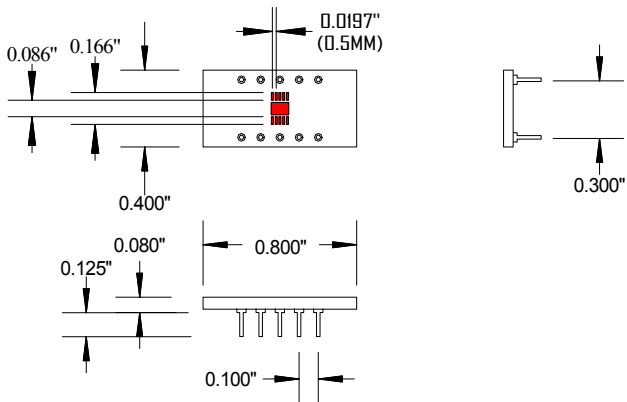

### AK10D300-MSOP

10 PIN MSOP(micro-soic) TO DIP

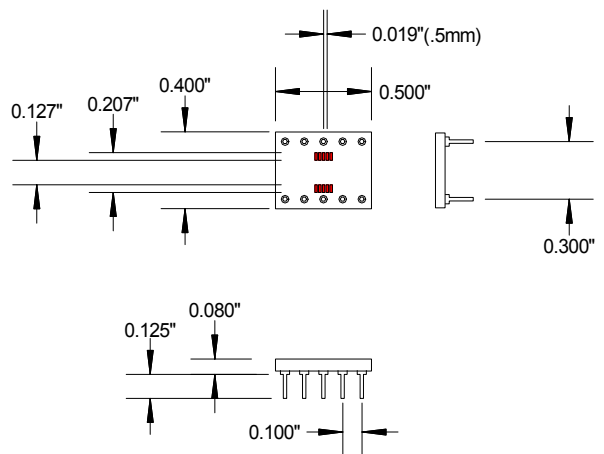

### AK12D400-VCO

12 PIN VCO TO DIP

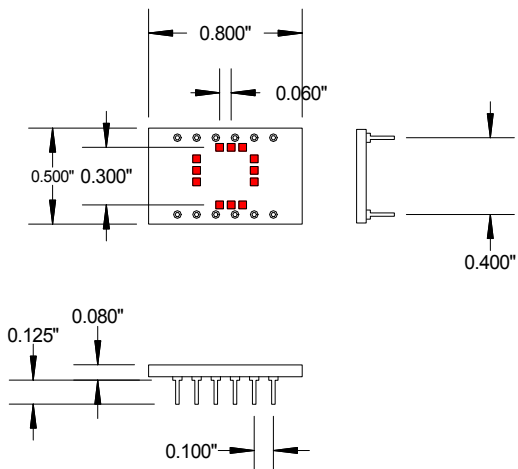

### AK14D-DFN5X5

LLP-DFN PACKAGE(5X5)  
TO 14 PIN DIP

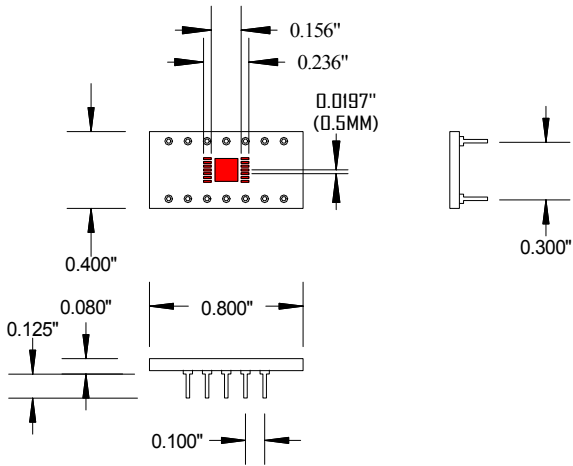

### AK14D300-QSOP

14 PIN QSOP & SSOP TO DIP

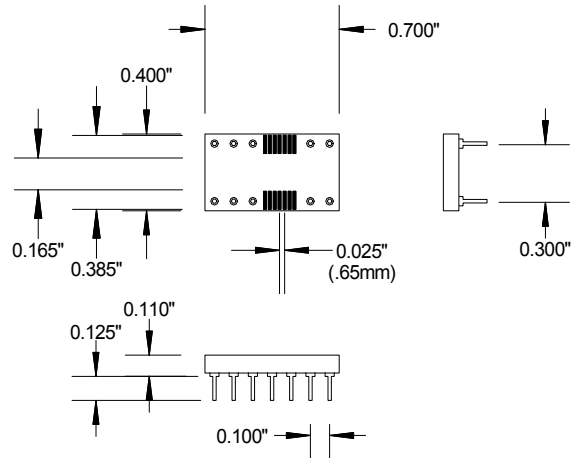

### AK14D300-TSOP

14 PIN TSOP & SSOP TO DIP

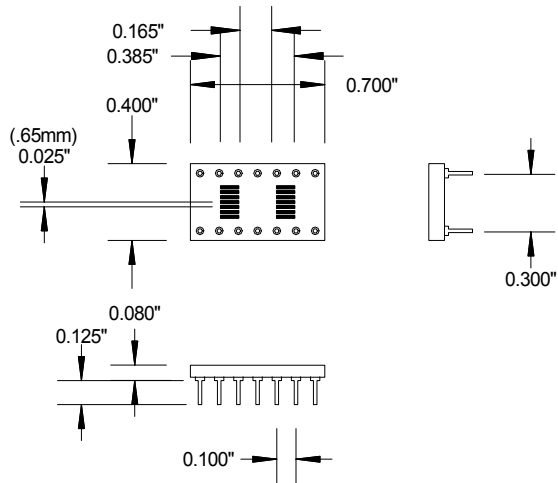

### AK14D300-NSO

14 PIN SOIC TO DIP

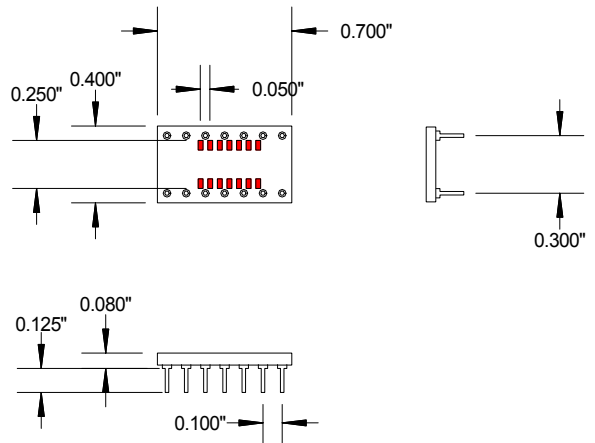

### AK14D300-WSO

14 PIN WIDE SOIC TO DIP

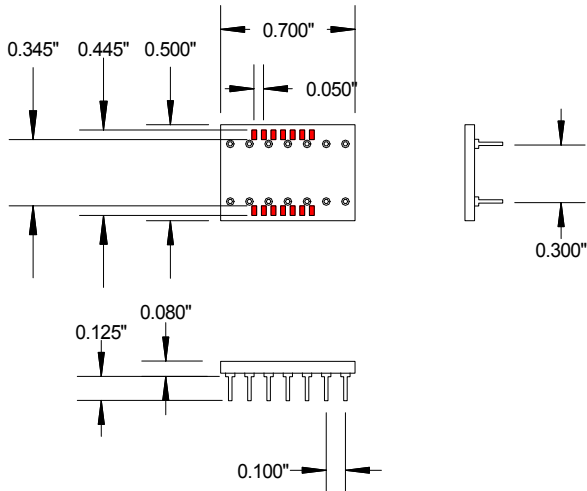

### AK14D300-HSOP

14 PIN HSOP TO DIP

