

General Purpose EMC Filter



- | EMC solution for industrial inverters and motor drives
- | Rated currents from 8 to 280 A
- | Selectable voltage level of 440 V and 520 V
- | High differential and common-mode attenuation
- | Compliant with IEC 60950



Performance indicators

Attenuation performance



Rated current [A]

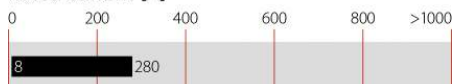

Approvals



FN 351 up to 110 A FN 351H up to 110 A

Features and benefits

- | Broad range of power ratings for fast and convenient filter selection
- | Available as 440 VAC (FN 351) and 520 VAC (FN 351H) versions for network-specific applications
- | FN 351 filters provide a broadband common and differential-mode attenuation performance, which remains available also when high interference levels are present
- | Solid, touch-safe filter terminals contribute to overall equipment safety and make the filters compliant with IEC 60950
- | Introduced as one of the very first motor drive EMC filters in the market, FN 351 has been widely imitated and has successfully proven its function over more than 10 years

Technical specifications

Design corresponding to	UL 1283, CSA 22.2 No. 8 1986, IEC/EN 60939
Flammability corresponding to	UL 94 V-2 or better
High potential test voltage	P → E 2600 VDC for 2 sec (FN 351) P → P 2250 VDC for 2 sec (FN 351H) P → E 2750 VDC for 2 sec (FN 351H) P → P 1900 VDC for 2 sec (FN 351)
Maximum continuous operating voltage	3x 440/250 VAC (FN 351) 3x 520/300 VAC (FN 351H)
MTBF @ 40°C/400V (Mil-HB-217F)	135,000 hours
Operating frequency	dc to 60 Hz
Overload capability	4x rated current at switch on, 1.5x rated current for 1 minute, once per hour
Protection category	IP20
Rated currents	8 to 280 A @ 40 °C
Temperature range (operation and storage)	-25 °C to +85 °C (25/085/21) (FN 351) -25 °C to +100 °C (25/100/21) (FN 351H)



Typical applications

- | Three-phase motor drives
- | Inverters and converters
- | Industrial automation equipment
- | UPS
- | SMPS
- | General purpose three-phase filtering

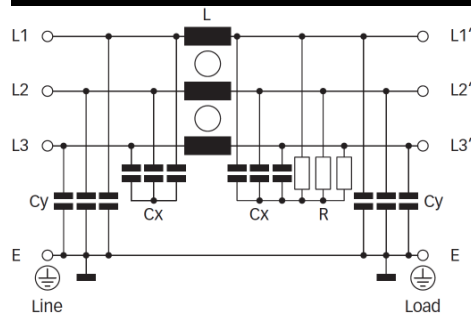
Typical electrical schematic



Filter selection table

Filter*	Rated current @ 40 °C (25 °C)	Typical drive power rating**	Leakage current*** @ 400 VAC/50 Hz	Power loss @ 25 °C/50 Hz	Input/Output connections		Weight [kg]
	[A]	[kW]	[mA]	[W]			
FN 351-8-29	8 (9.2)	3	1.9	7	-29		0.8
FN 351-16-29	16 (18.5)	5.5	1.9	8	-29		1.3
FN 351-25-33	25 (28.9)	11	28.0	8	-33		1.4
FN 351-36-33	36 (41.6)	15	28.0	9	-33		1.5
FN 351-50-..	50 (57.7)	22	29.5	11	-33	-34	1.6
FN 351-64-..	64 (73.9)	30	29.5	15	-33	-34	1.7
FN 351-80-34	80 (92.3)	37	31.8	23	-34		5.6
FN 351-110-35	110 (127)	55	31.8	25	-35		5.8
FN 351-180-36	180 (208)	90	29.6	49	-36		13.0
FN 351-280-37	280 (323)	132	35.7	70	-37		28.0
FN 351H-8-29	8 (9.2)	4	2.3	7	-29		1.1
FN 351H-16-29	16 (18.5)	7.5	2.3	8	-29		1.3
FN 351H-25-33	25 (28.9)	15	32.7	8	-33		1.4
FN 351H-36-33	36 (41.6)	18.5	32.7	9	-33		1.5
FN 351H-50-..	50 (57.7)	30	32.7	11	-33	-34	1.6
FN 351H-64-33	64 (73.9)	37	32.7	15	-33		1.7
FN 351H-80-34	80 (92.3)	45	38.0	23	-34		5.6
FN 351H-110-35	110 (127)	75	38.0	25	-35		5.8
FN 351H-180-36	180 (208)	110	35.6	49	-36		13.0
FN 351H-280-37	280 (323)	160	42.9	70	-37		28.0

* To compile a complete part number, please replace the .. with the required I/O connection style.

** Calculated at rated current, 400 VAC (FN 351)/480VAC (FN 351H) and cos phi = 0.8. The exact value depends upon the efficiency of the drive, the motor and the entire application.

*** Maximum leakage under normal operating conditions (FN 351 at 400 V, FN 351H at 480 V).

Note: if two phases are interrupted, worst case leakage could reach 6 times higher levels.

Typical filter attenuation

Per CISPR 17; A = 50 Ω/50 Ω sym; B = 50Ω/50Ω asym; C = 0.1 Ω/100 Ω sym; D = 100 Ω/0.1 Ω sym

8 A types

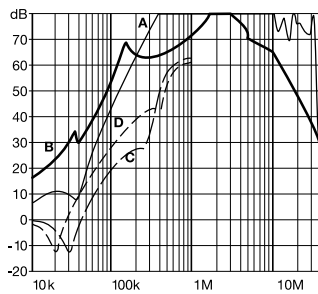

16 A types

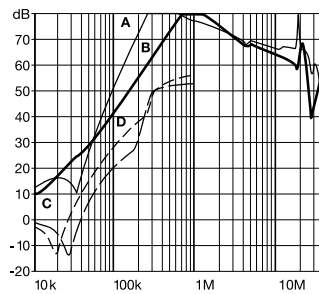

25 A types

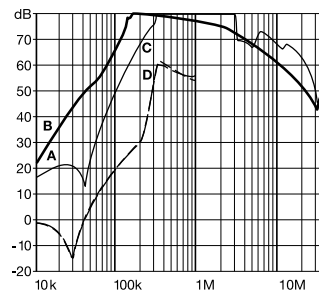

36 and 50 A types

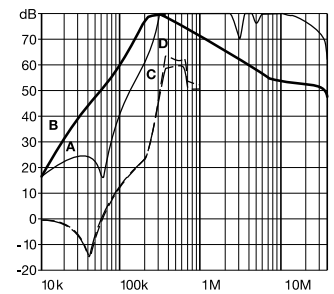

64 A types

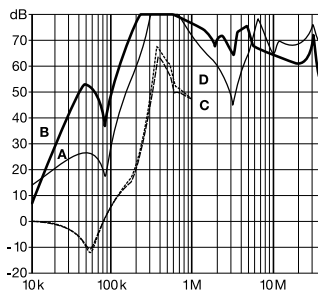

80 and 110 A types

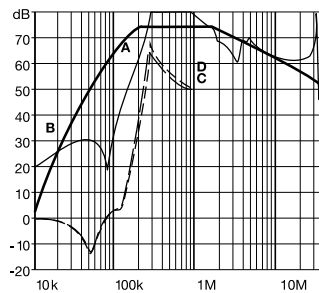

180 A types

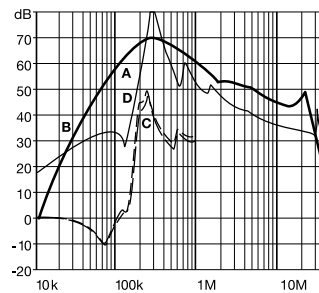

280 A types

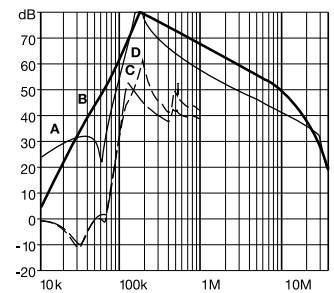

Mechanical data

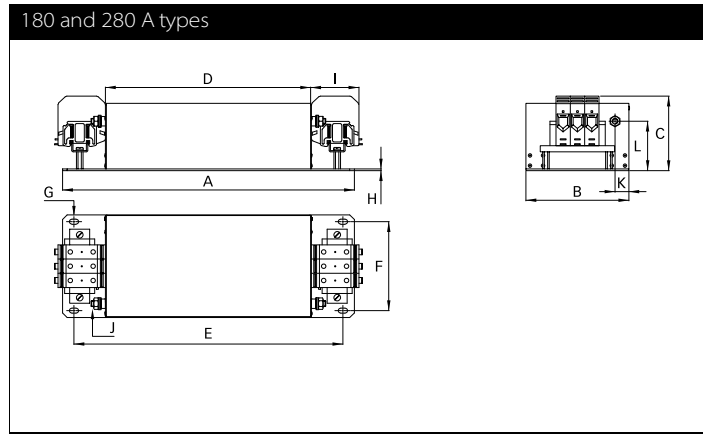
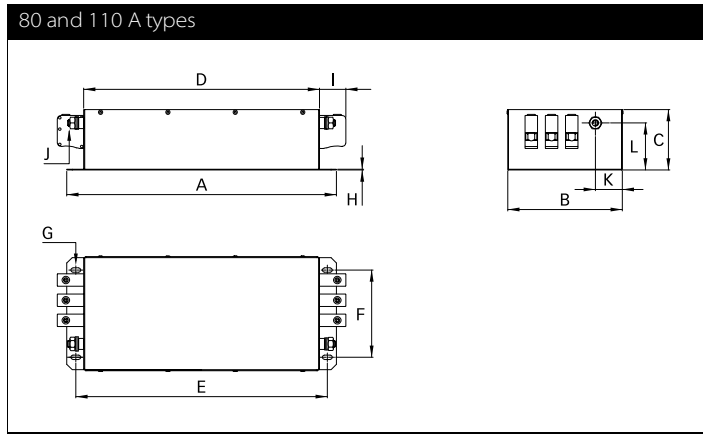
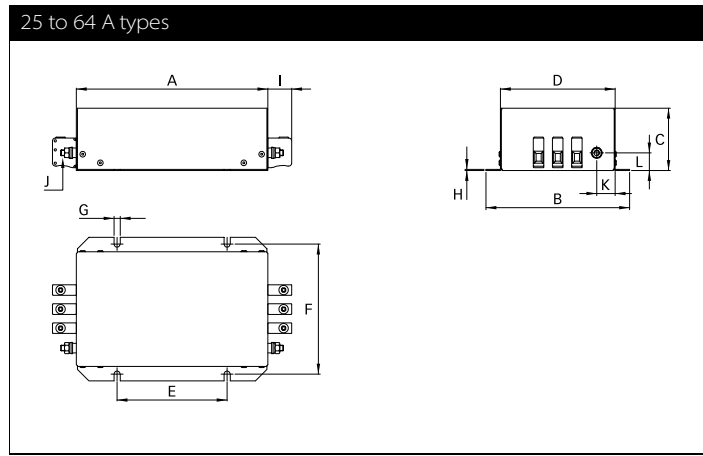
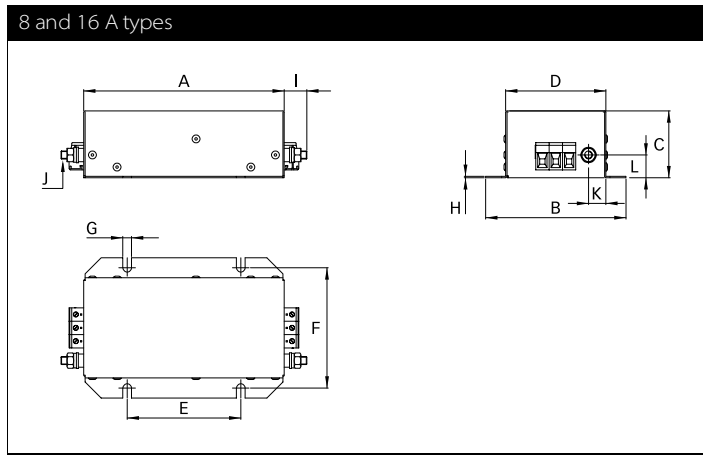







Dimensions

	8 A	8 A (-H)	16 A	25 A	36 A	50 A (-33)	50 A (-34)	64 A (-33)	64 A (-34)	80 A	110 A	180 A	280 A
A	180	200	200	200	200	200	200	200	200	400	400	510	700
B	115	150	150	150	150	150	150	150	150	170	170	180	260
C	60	65	65	65	65	65	65	65	80	90	90	133	155
D	85	120	120	120	120	120	120	120	120	350	350	360	530
E	115	115	115	115	115	115	115	115	115	373	373	470	660
F	100	136	136	136	136	136	136	136	136	130	130	156	220
G	6.5	6.5	6.5	6.5	6.5	6.5	6.5	6.5	6.5	15 x 6.5	15 x 6.5	16 x 9	16 x 9
H	1	1	1	1	1	1	1	1	1	1	1	4	4
I	17	17	17	25	25	25	39	25	39	39	45	83	110
J	M6	M6	M6	M6	M6	M6	M6	M6	M6	M10	M10	M10	M10
K	13	19.25	19.25	19.25	19.25	19.25	18.75	19.25	18.75	40	40	25	30
L	17	17	17	18.4	18.4	18.4	17	18.4	17	70	70	85	100

All dimensions in mm; 1 inch = 25.4 mm
Tolerances according: ISO 2768-m / EN 22768-m

Filter input/output connector cross sections

	-29	-33	-34	-35	-36	-37
						
Solid wire	6 mm ²	16 mm ²	35 mm ²	50 mm ²	95 mm ²	150 mm ²
Flex wire	4 mm ²	10 mm ²	25 mm ²	50 mm ²	95 mm ²	150 mm ²
AWG type wire	AWG 10	AWG 6	AWG 2	AWG 1/0	AWG 4/0	AWG 6/0
Recommended torque	0.6-0.8 Nm	1.5-1.8 Nm	4.0-4.5 Nm	7-8 Nm	17-20 Nm	27-30 Nm

Please visit www.schaffner.com to find more details on filter connectors.



Headquarters, global innovation and development center

Switzerland

Schaffner Group

Nordstrasse 11
4542 Luterbach
T +41 32 6816 626
F +41 32 6816 630
info@schaffner.com
<http://www.schaffner.com>



Sales and application centers

China

Schaffner EMC Ltd. Shanghai

T20-3, No 565 Chuangye Road
Pudong New Area
201201 Shanghai
T +86 21 3813 9500
F +86 21 3813 9501 / 02
cschina@schaffner.com
<http://www.schaffner.com.cn/>

Finland

Schaffner Oy

Sauvonrinne 19 H
08500 Lohja
T +358 19 35 72 71
finlandsales@schaffner.com

France

Schaffner EMC S.A.S.

112, Quai de Bezons
Boîte postale 133
95103 Argenteuil
T +33 1 34 34 30 60
F +33 1 39 47 02 28
francesales@schaffner.com

Germany

Schaffner Deutschland GmbH

Schoemperlenstrasse 12B
76185 Karlsruhe
T +49 721 56910
F +49 721 569110
germanysales@schaffner.com

Italy

Schaffner EMC S.r.l.

Via Galileo Galilei 47
20092 Cinisello Balsamo (MI)
T +39 02 66 04 30 45/47
F +39 02 61 23 943
italysales@schaffner.com

Japan

Schaffner EMC K.K.

1-32-12, Kamiyama, Setagaya-ku
7F Mitsui-seimei Sangenjaya Bldg.
154-0011 Tokyo
T +81 3 5712 3650
F +81 3 5712 3651
japansales@schaffner.com
<http://www.schaffner.jp>

Singapore

Schaffner EMC Pte Ltd.

Blk 3015A Ubi Road 1
05-09 Kampong Ubi Industrial Estate
408705 Singapore
T +65 6377 3283
F +65 6377 3281
singaporesales@schaffner.com

Spain

Schaffner EMC España

Calle Caléndula 93
Miniparc III, Edificio E
El Soto de la Moraleja
Alcobendas
28109 Madrid
T +34 618 176 133
spainsales@schaffner.com

Sweden

Schaffner EMC AB

Turebergstorg 1, 6
19147 Sollentuna
T +46 8 5792 1121 / 22
F +46 8 92 96 90
swedensales@schaffner.com

Switzerland

Schaffner EMV AG

Nordstrasse 11
4542 Luterbach
T +41 32 6816 626
F +41 32 6816 641
sales@schaffner.ch

Taiwan R.O.C.

Schaffner EMV Ltd.

6 Floor, No. 413
Rui Guang Road
114 Neihu District Taipei City
T +886 2 87525050
F +886 2 87518086
taiwansales@schaffner.com

Thailand

Schaffner EMC Co. Ltd.

Northern Region Industrial Estate
67 Moo 4 Tambon Ban Klang
Amphur Muang P.O. Box 14
51000 Lamphun
T +66 53 58 11 04
F +66 53 58 10 19
thailandsales@schaffner.com

UK

Schaffner Ltd.

5 Ashville Way
Molly Millars Lane
Wokingham
RG41 2PL Berkshire
T +44 118 9770070
F +44 118 9792969
uksales@schaffner.com
<http://www.schaffner.uk.com>

USA

Schaffner EMC Inc.

52 Mayfield Avenue
08837 Edison, New Jersey
T +1 800 367 5566
T +1 732 225 9533
F +1 732 225 4789
usasales@schaffner.com
<http://www.schaffner.com/us>

Schaffner MTC LLC

6722 Thirlane Road
24019 Roanoke, Virginia
T +1 276 228 7943
F +1 276 228 7953
<http://www.schaffner-mtc.com>

Schaffner Trencos LLC

2550 Brookpark Road
44134 Cleveland, Ohio
T +1 216 741 5282
F +1 216 741 4860
www.schaffner-trencos.com

To find your local partner within Schaffner's global network: www.schaffner.com

© 2014 Schaffner Group

The content of this document has been carefully checked and understood. However, neither Schaffner nor its subsidiaries assume any liability whatsoever for any errors or inaccuracies of this document and the consequences thereof. Published specifications are subject to change without notice. Product suitability for any area of application must ultimately be determined by the customer. In all cases, products must never be operated outside their published specifications. Schaffner does not guarantee the availability of all published products. This disclaimer shall be governed by substantive Swiss law and resulting disputes shall be settled by the courts at the place of business of Schaffner Holding AG. Latest publications and a complete disclaimer can be downloaded from the Schaffner website. All trademarks recognized.