

Cascadable Silicon Bipolar MMIC Amplifiers

Technical Data

MSA-0700

Features

- **Cascadable 50 Ω Gain Block**
- **Low Operating Voltage:**
4.0 V Typical V_d
- **3 dB Bandwidth:**
DC to 2.5 GHz
- **13.0 dB Typical Gain at
1.0 GHz**

Description

The MSA-0700 is a high performance silicon bipolar Monolithic Microwave Integrated Circuit (MMIC) chip. This MMIC is designed for use as a general purpose 50 Ω gain block. Typical applications include narrow and broad band IF and RF amplifiers in commercial, industrial and military applications.

The MSA-series is fabricated using HP's 10 GHz f_T , 25 GHz f_{MAX} , silicon bipolar MMIC process which uses nitride self-alignment, ion implantation, and gold metallization to achieve excellent performance, uniformity and reliability. The use of an external bias resistor for temperature and current stability also allows bias flexibility.

The recommended assembly procedure is gold-eutectic die attach at 400°C and either wedge or ball bonding using 0.7 mil gold wire.^[1] See APPLICATIONS section, "Chip Use".

Chip Outline^[1]

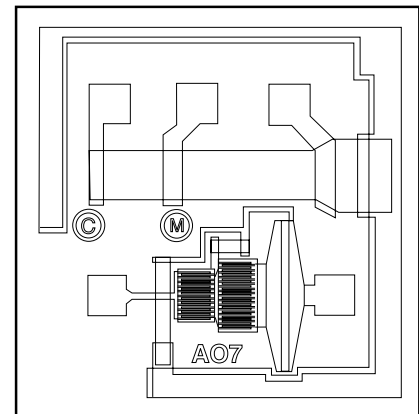

Note:

1. This chip contains additional biasing options. The performance specified applies only to the bias option whose bond pads are indicated on the chip outline. Refer to the APPLICATIONS section "Silicon MMIC Chip Use" for additional information.

Typical Biasing Configuration

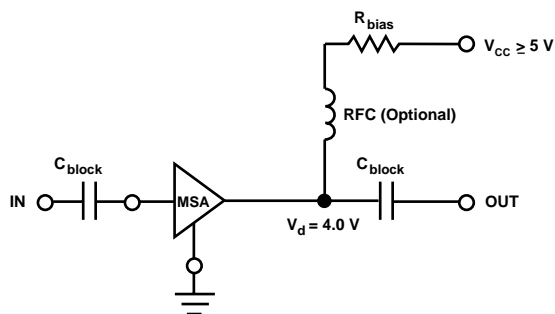

MSA-0700 Absolute Maximum Ratings

Parameter	Absolute Maximum ^[1]
Device Current	60 mA
Power Dissipation ^[2,3]	275 mW
RF Input Power	+13 dBm
Junction Temperature	200°C
Storage Temperature	-65 to 200°C

Thermal Resistance^[2,4]:

$$\theta_{jc} = 50^{\circ}\text{C/W}$$

Notes:

1. Permanent damage may occur if any of these limits are exceeded.
2. $T_{\text{Mounting Surface}} = 25^{\circ}\text{C}$.
3. Derate at 20 mW/°C for $T_{\text{Mounting Surface}} > 186^{\circ}\text{C}$.
4. The small spot size of this technique results in a higher, though more accurate determination of θ_{jc} than do alternate methods. See MEASUREMENTS section “Thermal Resistance” for more information.

Electrical Specifications^[1], $T_A = 25^{\circ}\text{C}$

Symbol	Parameters and Test Conditions ^[2] : $I_d = 22 \text{ mA}$, $Z_o = 50 \Omega$	Units	Min.	Typ.	Max.
G _P	Power Gain ($ S_{21} ^2$)	f = 0.1 GHz		13.5	
ΔG_P	Gain Flatness	f = 0.1 to 1.5 GHz		±0.6	
f _{3 dB}	3 dB Bandwidth			2.5	
VSWR	Input VSWR	f = 0.1 to 2.5 GHz		2.0:1	
	Output VSWR	f = 0.1 to 2.5 GHz		1.6:1	
NF	50 Ω Noise Figure	f = 1.0 GHz		4.5	
P _{1 dB}	Output Power at 1 dB Gain Compression	f = 1.0 GHz		5.5	
IP ₃	Third Order Intercept Point	f = 1.0 GHz		19.0	
t _D	Group Delay	f = 1.0 GHz		130	
V _d	Device Voltage		3.6	4.0	4.4
dV/dT	Device Voltage Temperature Coefficient			-7.0	

Notes:

1. The recommended operating current range for this device is 15 to 40 mA. Typical performance as a function of current is on the following page.
2. RF performance of the chip is determined by packaging and testing 10 devices per wafer in a dual ground configuration.

Part Number Ordering Information

Part Number	Devices Per Tray
MSA-0700-GP4	up to 100

MSA-0700 Typical Scattering Parameters^[1] ($Z_0 = 50 \Omega$, $T_A = 25^\circ\text{C}$, $I_d = 22 \text{ mA}$)

Freq. GHz	S_{11}		S_{21}			S_{12}			S_{22}		k
	Mag	Ang	dB	Mag	Ang	dB	Mag	Ang	Mag	Ang	
0.1	.04	-5	13.5	4.75	176	-18.6	.118	2	.20	-9	1.14
0.2	.05	-8	13.5	4.74	172	-18.4	.120	3	.19	-16	1.14
0.4	.06	-19	13.5	4.74	163	-18.3	.121	7	.20	-30	1.13
0.6	.08	-32	13.5	4.71	156	-18.1	.124	9	.21	-44	1.12
0.8	.10	-41	13.4	4.67	147	-17.5	.133	12	.23	-69	1.07
1.0	.12	-50	13.2	4.59	138	-17.6	.133	13	.23	-68	1.07
1.5	.20	-73	12.7	4.30	117	-16.6	.147	17	.23	-91	1.01
2.0	.31	-98	12.1	4.05	97	-15.8	.163	17	.22	-105	0.94
2.5	.38	-112	11.0	3.55	85	-15.3	.171	18	.18	-103	0.93
3.0	.43	-128	9.6	3.01	69	-15.3	.171	17	.19	-96	0.97
3.5	.48	-141	8.2	2.57	56	-15.3	.172	17	.21	-87	1.01
4.0	.48	-153	6.8	2.20	45	-15.2	.174	14	.26	-83	1.07
5.0	.49	-179	4.6	1.70	26	-15.2	.174	12	.31	-86	1.22
6.0	.54	154	2.5	1.34	9	-15.6	.166	13	.33	-98	1.38

Note:

- S-parameters are de-embedded from 70 mil package measured data using the package model found in the DEVICE MODELS section.

Typical Performance, $T_A = 25^\circ\text{C}$

(unless otherwise noted)

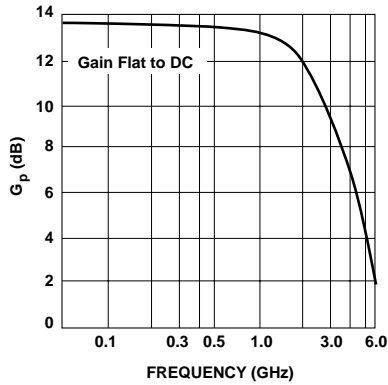

Figure 1. Typical Power Gain vs. Frequency, $I_d = 22 \text{ mA}$.

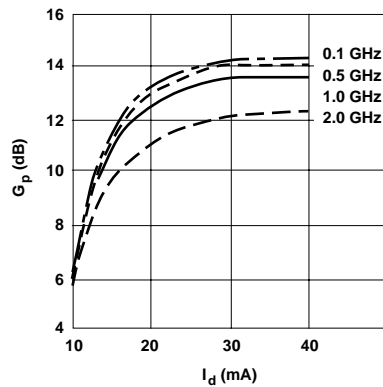

Figure 2. Power Gain vs. Current.

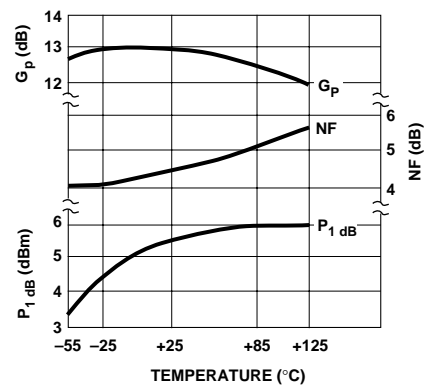

Figure 3. Output Power at 1 dB Gain Compression, NF and Power Gain vs. Mounting Surface Temperature, $f = 1.0 \text{ GHz}$, $I_d = 22 \text{ mA}$.

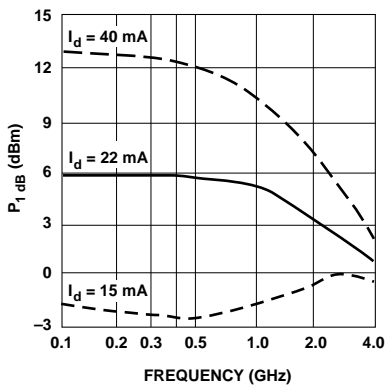

Figure 4. Output Power at 1 dB Gain Compression vs. Frequency.

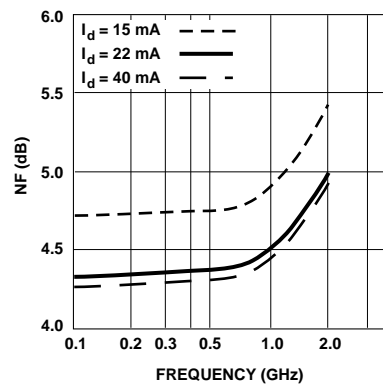
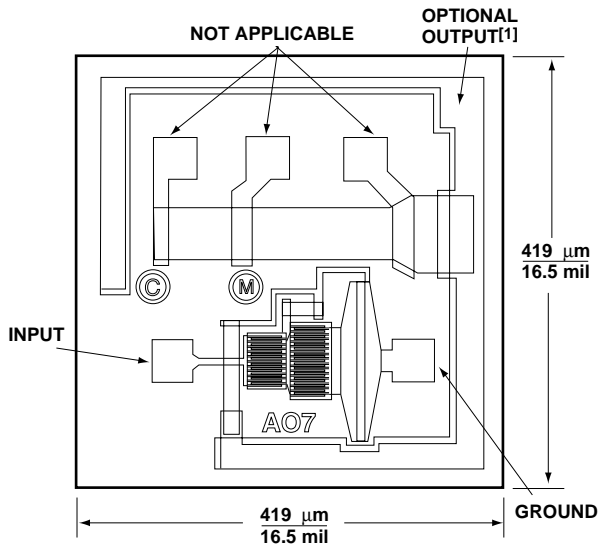

Figure 5. Noise Figure vs. Frequency.

MSA-0700 Chip Dimensions



Unless otherwise specified, tolerances are $\pm 13 \mu\text{m}/\pm 0.5 \text{ mils}$. Chip thickness is $114 \mu\text{m}/4.5 \text{ mil}$. Bond Pads are $41 \mu\text{m}/1.6 \text{ mil}$ typical on each side. Note 1: Output contact is made by die attaching the backside of the die.