

PRODUCT SPECIFICATION

Part Number
PDM8876x-B01

Details

- 0.76" (19.4mm) Dot Matrix Display
- 8x8 Array
- Available in Common Anode or Cathode
- Emitting Color: Blue

Features

- Low power consumption
- RoHS Compliant
- Gray or Black Face, White Segment
- Easy mounting on PCB or socket

Mechanical Dimensions

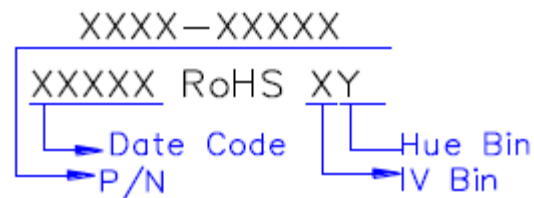
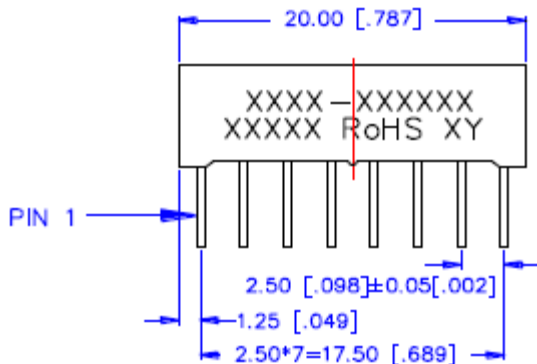
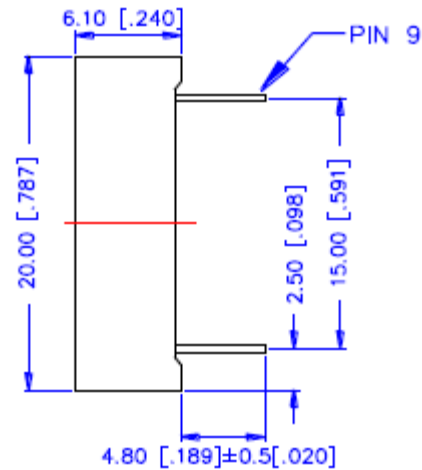
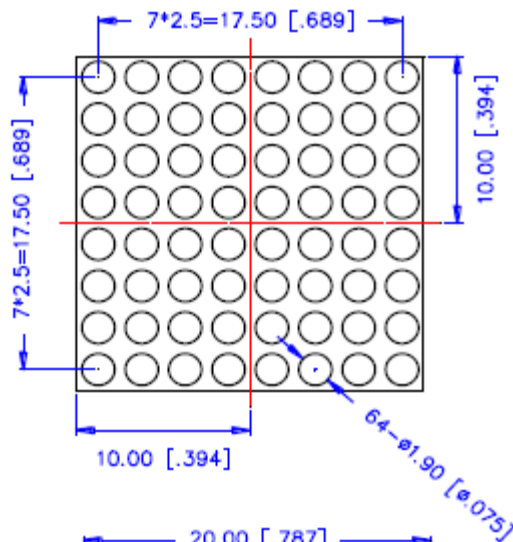

Notes:

1. Dimensions in millimeters [inch], and tolerance is ± 0.25 [.010] and angle is $\pm 1^\circ$ unless otherwise noted.
2. Bending \leq Length*1%
3. All pins are $\varnothing 0.45$ [.018] ± 0.1 [.004]
4. Specifications subject to change without notice



Device Selection Guide

Model Number	Chip		Description
	Material	Emitting Color	
PDM8876C-B01	InGaN	Blue	Common Cathode
PDM8876A-B01			Common Anode

Absolute Maximum Ratings at Ta=25°C

Parameter	Symbol	Rating	Unit
Power Dissipation per Dice	PAD	114	mW
Derating Liner from 25°C per Dice	--	0.4	mA/°C
Continuous Forward Current Per Dice	IAF	30	mA
Peak Current Per Dice (duty cycle 1/10, 1KHz)	IPF	100	mA
Reverse Voltage Per Dice	VR	5	V
Electrostatic Discharge (HBM)	ESD	1000	V
Operating Temperature	Topr	-35 ~ +85	°C
Storage Temperature	Tstg	-35 ~ +85	°C

Typical Electrical and Optical Characteristics at Ta=25°C

Parameter	Symbol	Min.	Typ.	Max.	Unit	Condition
Forward Voltage Per Segment	VF	--	3.2	3.8	V	IF=20mA
Luminous Intensity Per Segment	Iv	--	30	--	mcd	IF=10mA
Peak Emission Wavelength / Dominant Wavelength	$\lambda P/\lambda d$	--	*465	--	nm	IF=20mA
Reverse Current	IR	--	--	50	μ A	VR=5V
Luminous Intensity Matching Ratio	Iv-m	--	--	2:1	--	IF=10mA

Typical Electrical/Optical Characteristic Curves

($T_a = 25^\circ\text{C}$ Unless Otherwise Noted)

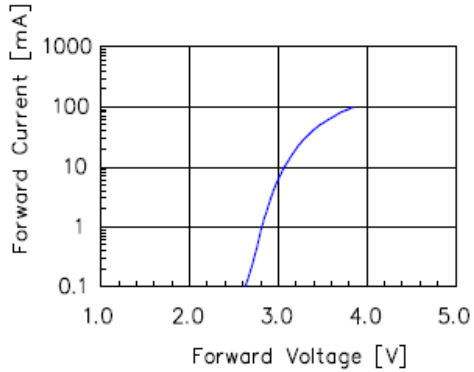

Fig 1. Forward Current vs. Forward Voltage

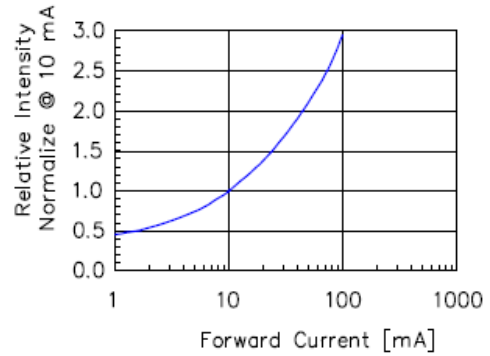

Fig 2. Relative Intensity vs. Forward Current

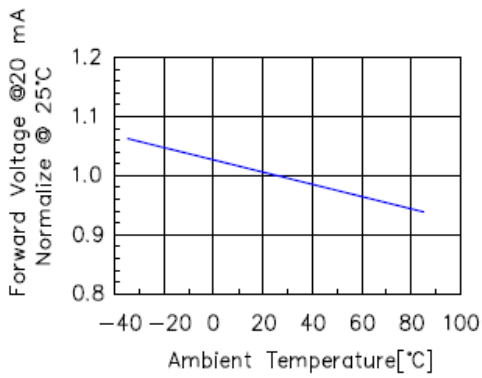

Fig 3. Forward Voltage vs. Temperature

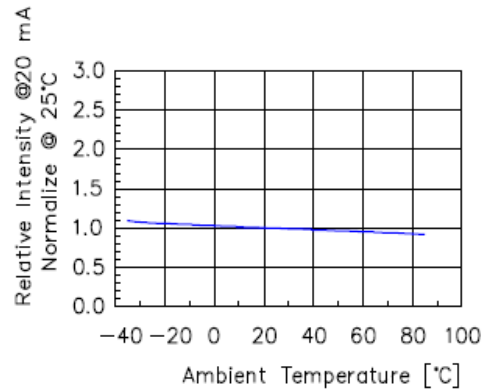

Fig 4. Relative Intensity vs. Temperature

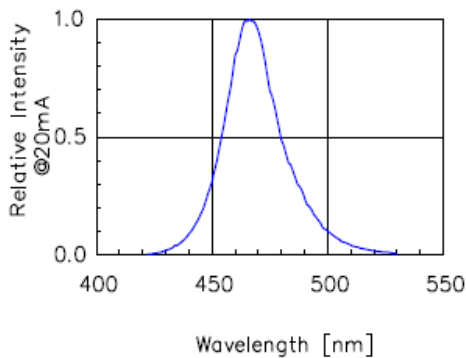

Fig 5. Relative Intensity vs. Wavelength

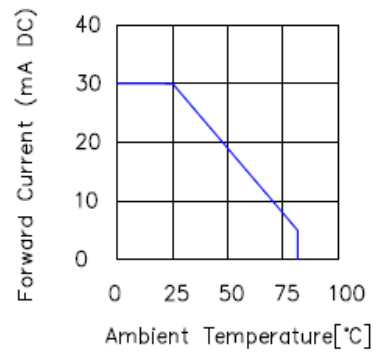

Fig 6. Forward Current vs. Ambient Temperature

Luminous General I_v Bin Grade (I_F = 10mA)

A	B	C	D	E	F	G	H	J	K	L	M
0.627	0.816	1.062	1.382	1.797	2.337	3.039	3.952	5.138	6.681	8.686	11.293
0.815	1.061	1.381	1.796	2.336	3.038	3.951	5.137	6.680	8.685	11.292	14.681
N	P	Q	R	S	T	U	V	W	X	Y	1
14.682	19.088	24.815	32.261	41.940	54.523	70.881	92.146	119.791	155.730	202.450	263.185
19.087	24.814	32.260	41.939	54.522	70.880	92.145	119.790	155.729	202.449	263.184	342.141
2	3	4	5	6	7	8	9				
342.142	444.786	578.222	751.690	977.198	1270.359	1651.467	2146.908				
444.785	578.221	751.689	977.197	1270.358	1651.466	2146.907	2790.981				

Remark: Unit=mcd

*Tolerance: ±20%

Color Rank Limits (I_F=20mA)

2	3	4	5	6
456.0	459.0	462.0	465.0	468.0
459.0	462.0	465.0	468.0	471.0

Remark: Unit=nm

*Tolerance: ±1

All Light-On Segments Feature & Pad Position

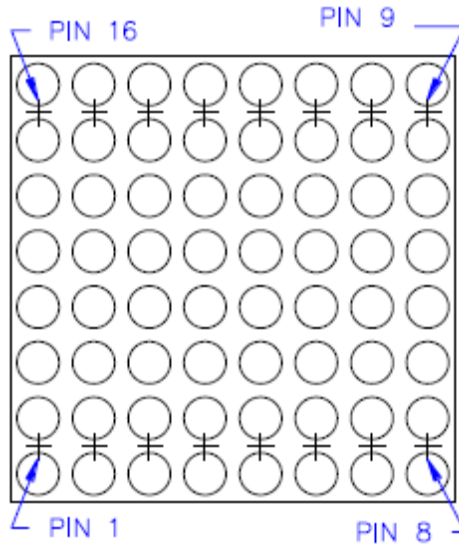

Internal Circuit Diagram

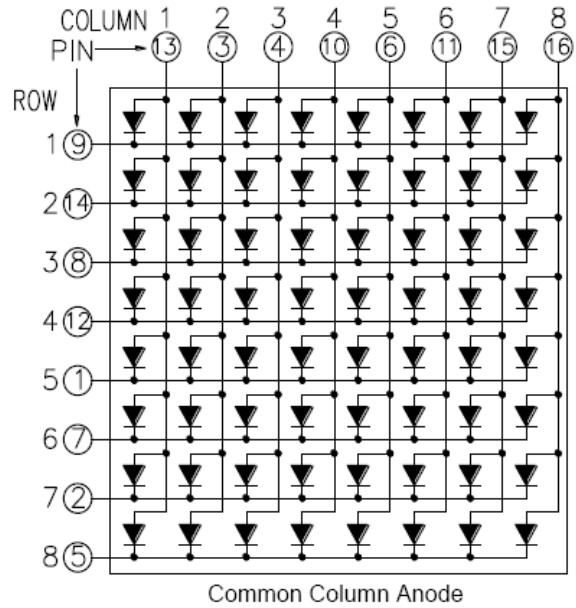
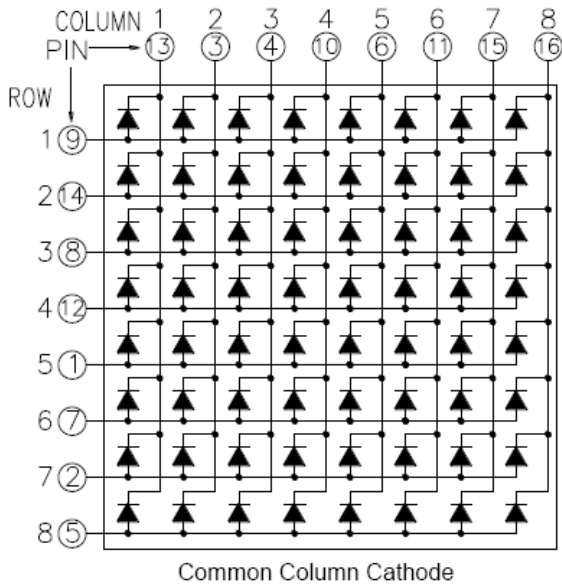

Precautions for Use

1. Recommended soldering conditions

1.1. Wave soldering

Basic SPEC is ≤ 5 sec. When 260°C . If temperature is higher, time should be shorter ($+10^{\circ}\text{C} \rightarrow -1$ sec.).

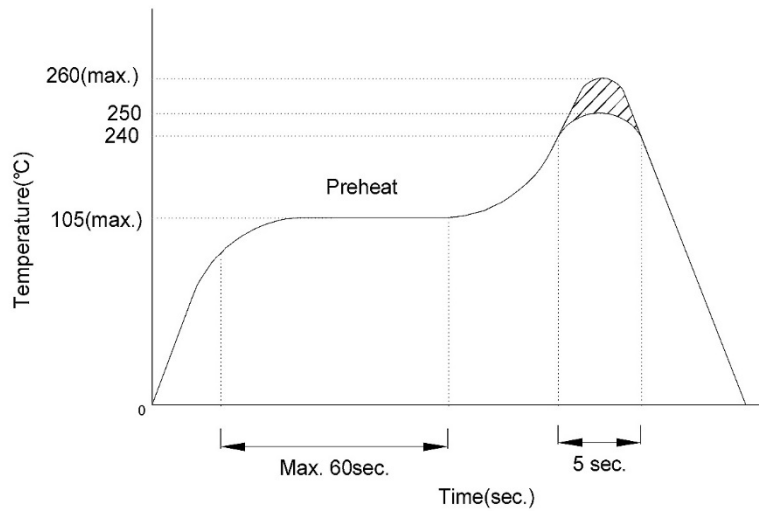

1.2. Soldering Iron:

Power dissipation of iron should be smaller than 15W and temp should be controllable. Soldering temperature should be under 260°C , time ≤ 3 sec.

Packing Specifications

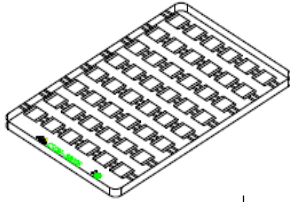

1 Tray From Box = 48 PCS
Tray Size:
L300 x W195 x H15mm

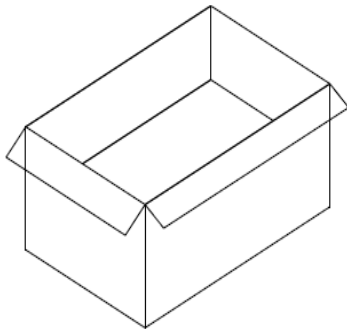
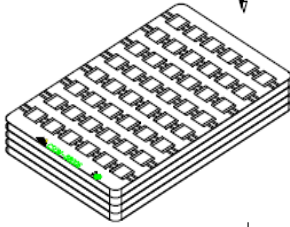

15 Trays Per Inner Box
Q'TY: 720 PCS.
Box Size:
L300 x W205 x H240mm

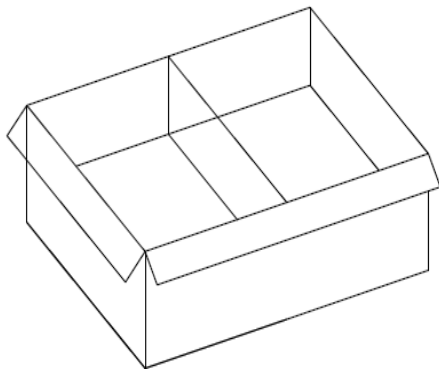

2 Inner Boxes Per Carton,
Total Q'TY: 1440 Pcs
Carton Size:
L431 x W320 x H252mm

Note: Specifications subject to change without notice