

Features

- Attenuation: 0.5 dB Steps to 31.5 dB
- Low DC Power Consumption
- Plastic SOIC, Wide Body, SMT Package
- Integral TTL Driver
- 50 ohm Impedance
- Test Boards are Available
- Tape and Reel Packaging Available
- SOW-24 Package

Description

M/A-COM's AT65-0107 is a GaAs FET 6-bit digital attenuator with a 0.5 dB minimum step size and a 31.5 dB total attenuation range. This device is in a SOIC-24 wide body, plastic surface mount package. The AT65-0107 is ideally suited for use where accuracy, fast speed, very low power consumption and low costs are required.

Schematic with Off-Chip Components

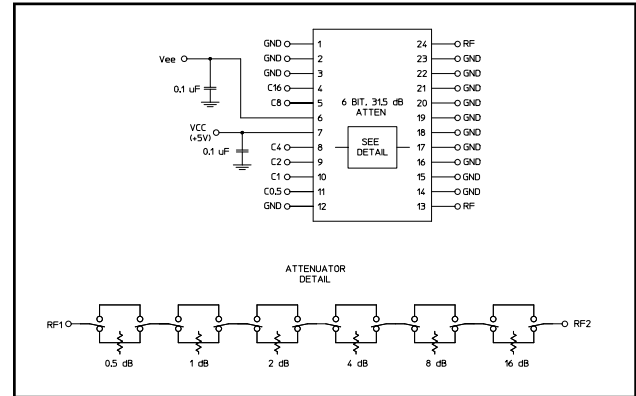

Ordering Information

Part Number	Package
AT65-0107	Bulk Packaging
AT65-0107TR	1000 piece reel
AT65-0107-TB	Sample Test Board

Note: Reference Application Note M513 for reel size information.

Pin Configuration

Pin No.	Function	Pin No.	Function
1	GND	13	RF
2	GND	14	GND
3	GND	15	GND
4	C16	16	GND
5	C8	17	GND
6	Vee	18	GND
7	Vcc	19	GND
8	C4	20	GND
9	C2	21	GND
10	C1	22	GND
11	C0.5	23	GND
12	GND	24	RF

Electrical Specifications: $T_A = 25^\circ\text{C}$

Parameter	Test Conditions	Frequency	Units	Min	Typ	Max
Insertion Loss	—	DC - 1.0 GHz	dB	—	3.1	3.6
		DC - 2.0 GHz	dB	—	3.6	4.2
Attenuation Accuracy	Any Bit or Combination of Bits	DC - 2.0 GHz	dB	—	—	$\pm(.3 + 4\% \text{ of atten.})$
VSWR	Full Range	DC - 2.0 GHz	Ratio	—	1.8:1	2:1
Switching Speed	50% Cntl to 90%/10% RF 10% to 90% or 90% to 10%	—	nS	—	75	150
		—	nS	—	20	50
1 dB Compression	—	50 MHz 0.5 - 2.0 GHz	dBm	—	+21	—
			dBm	—	+29	—
Input IP_3	Two-tone inputs up to +5 dBm	50 MHz 0.5-2.0 GHz	dB	—	+35	—
			dB	—	+48	—
V_{CC}^1	—	—	V	4.75	5.0	5.25
V_{EE}^1	—	—	V	-8.0	-5.0	-4.75
V_{IL} V_{IH}	LOW-level input voltage HIGH-level input voltage	—	V	0.0	—	0.8
		—	V	2.0	—	5.0
I_{in} (Input Leakage Current)	$V_{in} = V_{CC}$ or GND	—	μA	-1.0	—	1.0
I_{CC} (Quiescent Supply Current)	$V_{cntrl} = V_{CC}$ or GND	—	μA	—	250	400
ΔI_{CC} (Additional Supply Current Per TTL Input Pin)	$V_{CC} = \text{Max}$, $V_{cntrl} = V_{CC} - 2.1 \text{ V}$	—	mA	—	—	1.0
I_{EE}	V_{EE} min to max, $V_{in} = V_{IL}$ or V_{IH}	—	mA	-1.0	-0.2	—

- Decoupling capacitors (.1 μF) are required on Power Supply lines.

Absolute Maximum Ratings^{2,3}

Parameter	Absolute Maximum
Max. Input Power 0.05 GHz 0.5 - 2.0 GHz	+27 dBm +34 dBm
V_{CC}	$-0.5\text{V} \leq V_{CC} \leq +7.0\text{V}$
V_{EE}	$-8.5\text{V} \leq V_{EE} \leq +0.5\text{V}$
$V_{CC} - V_{EE}$	$-0.5\text{V} \leq V_{CC} - V_{EE} \leq 14.5\text{V}$
V_{in}^4	$-0.5\text{V} \leq V_{in} \leq V_{CC} + 0.5\text{V}$
Operating Temperature	-40°C to $+85^\circ\text{C}$
Storage Temperature	-65°C to $+125^\circ\text{C}$

- Exceeding any one or combination of these limits may cause permanent damage to this device.
- M/A-COM does not recommend sustained operation near these survivability limits.
- Standard CMOS TTL interface, latch-up will occur if logic signal is applied prior to power supply.

Handling Procedures

Please observe the following precautions to avoid damage:

Static Sensitivity

Gallium Arsenide Integrated Circuits are sensitive to electrostatic discharge (ESD) and can be damaged by static electricity. Proper ESD control techniques should be used when handling these devices.

Truth Table (Digital Attenuator)

C16	C8	C4	C2	C1	C0.5	Attenuation
0	0	0	0	0	0	Loss. Reference
0	0	0	0	0	1	0.5 dB
0	0	0	0	1	0	1.0 dB
0	0	0	1	0	0	2.0 dB
0	0	1	0	0	0	4.0 dB
0	1	0	0	0	0	8.0 dB
1	0	0	0	0	0	16.0 dB
1	1	1	1	1	1	31.5 dB

0 = TTL Low; 1 = TTL High

Typical Performance Curves

Loss vs. Temperature

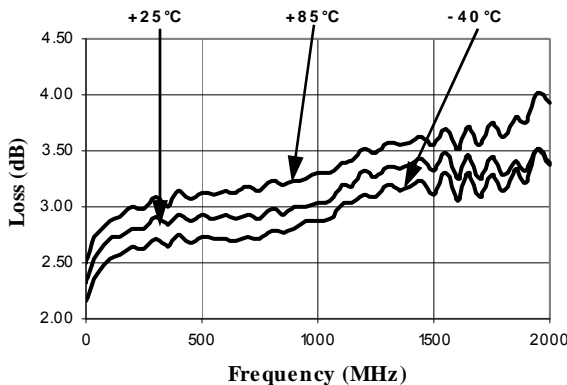

0.5 dB Bit vs. Temperature

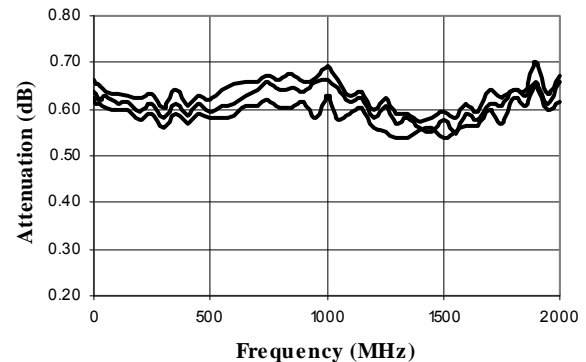

1 dB Bit vs. Temperature

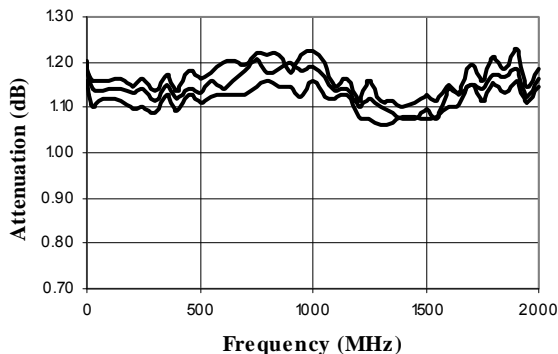

2 dB Bit vs. Temperature

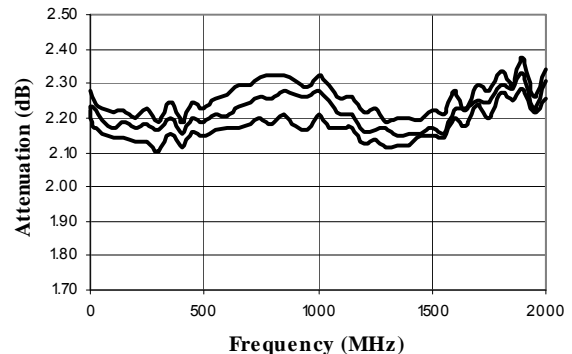

Typical Performance Curves

4 dB Bit vs. Temperature

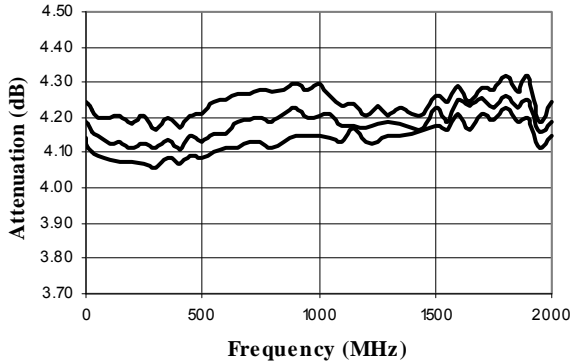

8 dB Bit vs. Temperature

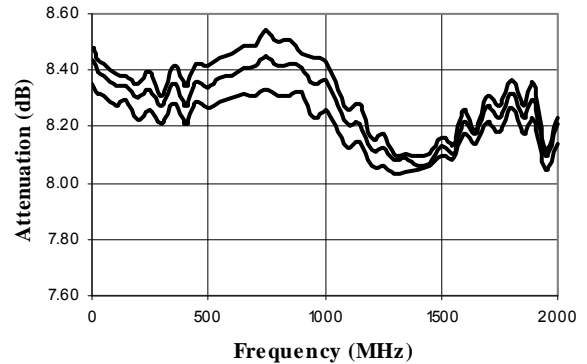

16 dB Bit vs. Temperature

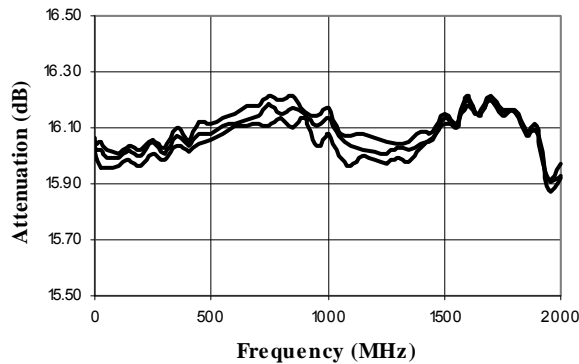

Max Attenuation vs. Temperature

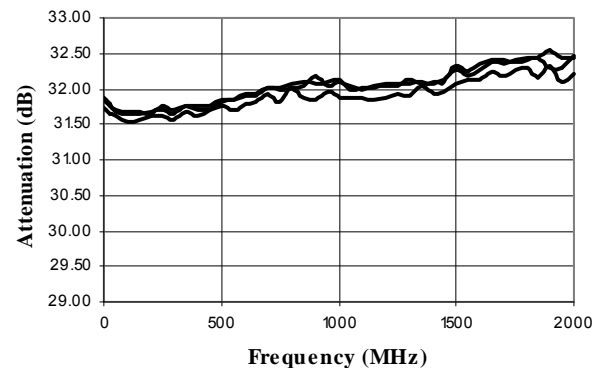

VSWR @ Insertion Loss

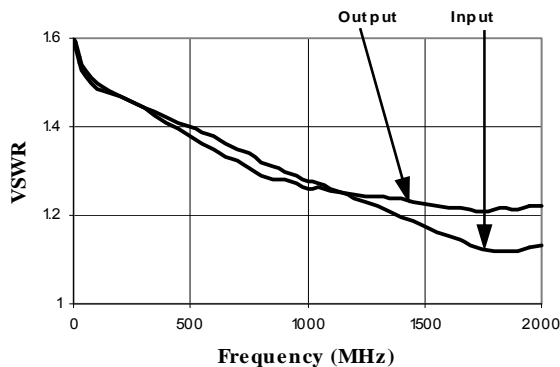

VSWR, 0.5 dB Bit

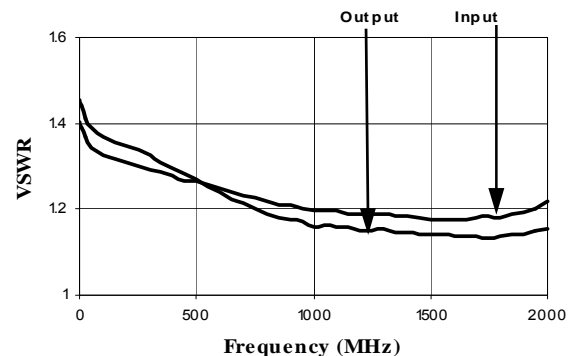

Typical Performance Curves

VSWR, 1 dB Bit

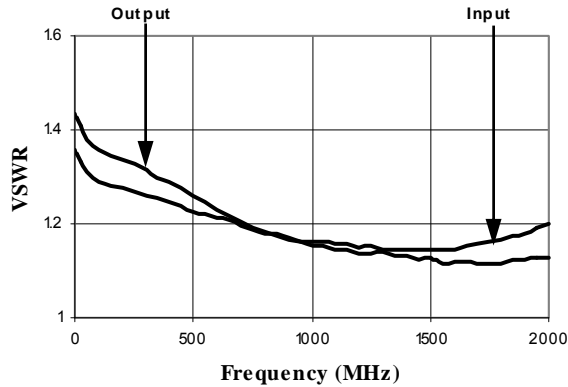

VSWR, 2 dB Bit

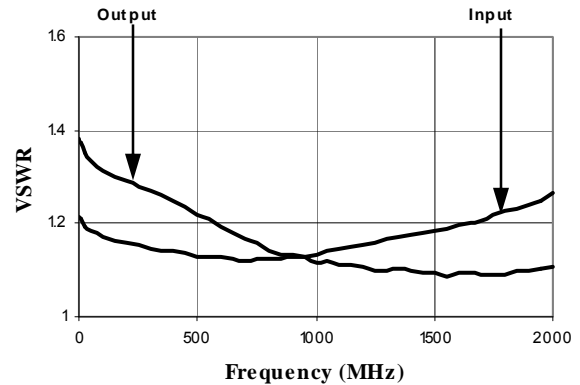

VSWR, 4 dB Bit

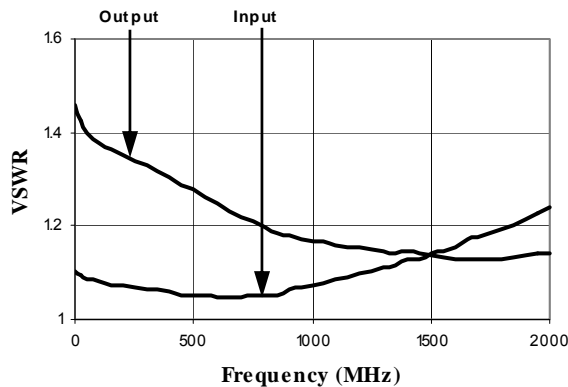

VSWR, 8 dB Bit

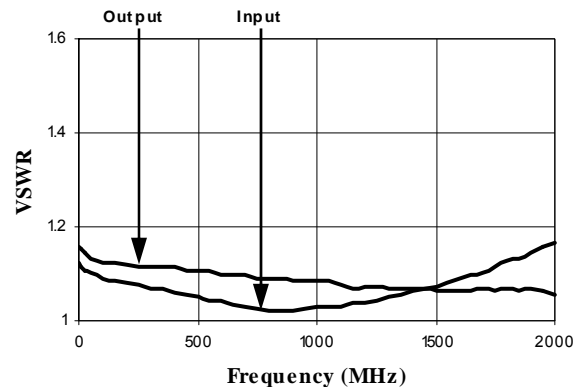

VSWR, 16 dB Bit

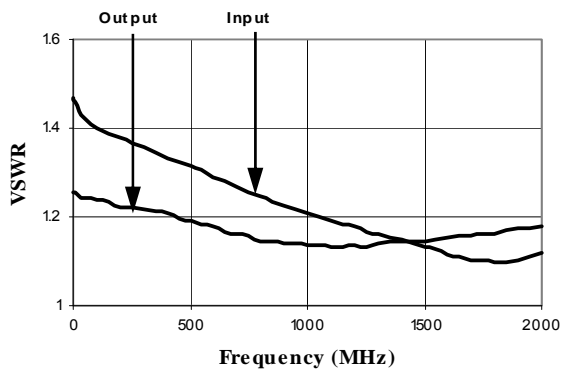

VSWR, Maximum Attenuation

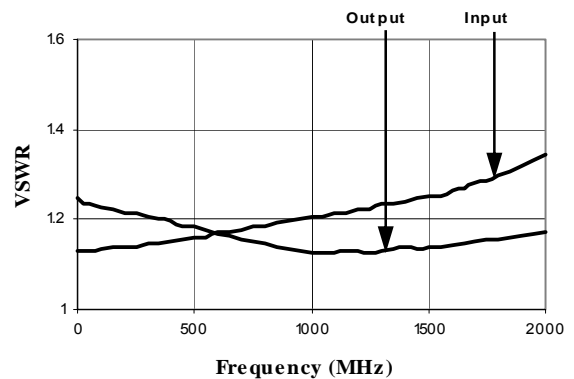

AT65-0107

Digital Attenuator
31.5 dB, 6-Bit, TTL Driver, DC-2.0 GHz

Rev. V6

SOW-24[†]

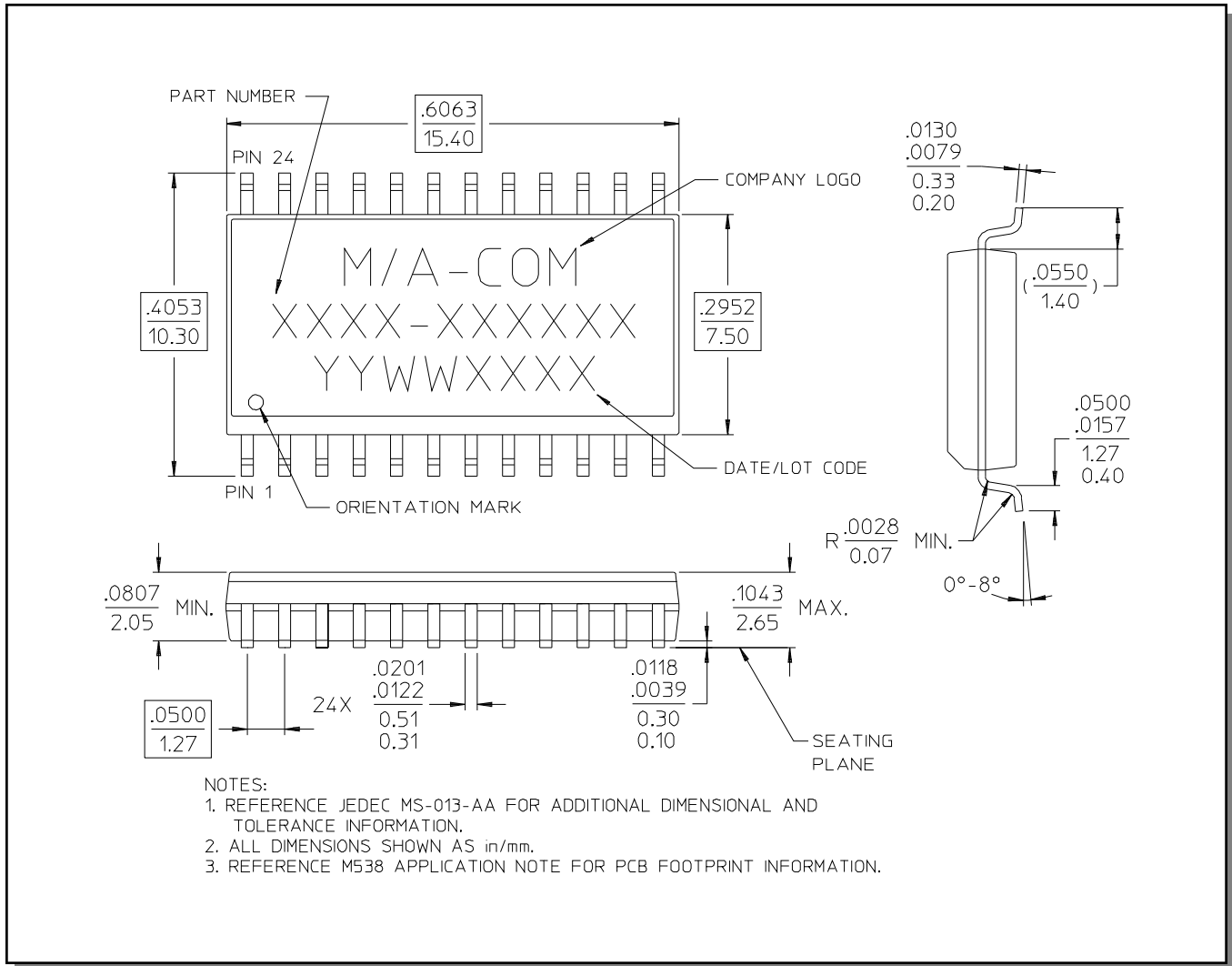

[†] Reference Application Note M538 for lead-free solder reflow recommendations.