

Electrical / Environmental

HM28



Buckle Style Core Common-Mode Chokes

- Insulation Resistance, Minimum 100 MΩ
- Voltage Rating 250VAC
- Insulation System Class B, 130°C
- Temperature Rise, Maximum 40°C

Schematic

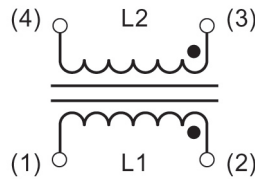

Specifications @ 25°C / Packaging

Part Number	Current Rating Amps AC	Inductance @ 1.0 kHz mH Min.	DCR Ω Max.	Figure	Carton Box Qty (Units)	Part Number	Current Rating Amps AC	Inductance @ 1.0 kHz mH Min.	DCR Ω Max.	Figure	Carton Box Qty (Units)
HM28-20001LF	0.50	9	1.40	1	400	HM28-25033LF	3.0	5	0.10	4	330
HM28-20002LF	0.60	4.5	0.75	1	400	HM28-32018LF	0.50	36	2.70	5	400
HM28-20003LF	0.70	2.5	0.40	1	400	HM28-32019LF	0.60	24	1.60	5	400
HM28-20004LF	0.90	1.1	0.25	1	400	HM28-32020LF	0.70	9.2	0.75	5	400
HM28-20005LF	1.0	0.45	0.13	1	400	HM28-32021LF	0.90	7.8	0.50	5	400
HM28-24006LF	0.50	9	1.40	2	400	HM28-32022LF	1.0	5.2	0.34	5	400
HM28-24007LF	0.60	4.5	0.75	2	400	HM28-32023LF	1.50	3.6	0.25	5	400
HM28-24008LF	0.70	2.5	0.40	2	400	HM28-32024LF	2.0	3.2	0.20	5	400
HM28-24009LF	0.90	1.1	0.25	2	400	HM28-35034LF	0.50	120	2.60	6	231
HM28-24010LF	1.0	0.45	0.13	2	400	HM28-35035LF	0.60	92	2.0	6	231
HM28-24011LF	0.50	36	2.70	3	300	HM28-35036LF	0.70	66	1.50	6	231
HM28-24012LF	0.60	24	1.60	3	300	HM28-35037LF	0.90	36	0.80	6	231
HM28-24013LF	0.70	9.2	0.75	3	300	HM28-35038LF	1.0	25	0.60	6	231
HM28-24014LF	0.90	7.8	0.50	3	300	HM28-35039LF	1.50	15.5	0.32	6	231
HM28-24015LF	1.0	5.2	0.34	3	300	HM28-35040LF	2.0	10	0.25	6	231
HM28-24016LF	1.50	3.6	0.25	3	300	HM28-35041LF	2.50	8	0.19	6	231
HM28-24017LF	2.0	3.2	0.20	3	300	HM28-35042LF	3.0	5	0.10	6	231
HM28-25025LF	0.50	120	2.60	4	330	HM28-42051LF	1.50	33	0.50	7	144
HM28-25026LF	0.60	92	2.0	4	330	HM28-42052LF	1.80	22	0.40	7	144
HM28-25027LF	0.70	66	1.50	4	330	HM28-42053LF	2.0	18	0.30	7	144
HM28-25028LF	0.90	36	0.80	4	330	HM28-42054LF	2.50	12	0.20	7	144
HM28-25029LF	1.0	25	0.60	4	330	HM28-42055LF	2.70	10	0.15	7	144
HM28-25030LF	1.50	15.5	0.32	4	330	HM28-42056LF	3.0	8.1	0.12	7	144
HM28-25031LF	2.0	10	0.25	4	330	HM28-42057LF	3.50	6	0.10	7	144
HM28-25032LF	2.50	8	0.19	4	330	HM28-42058LF	4.0	4.7	0.08	7	144

Ordering Information

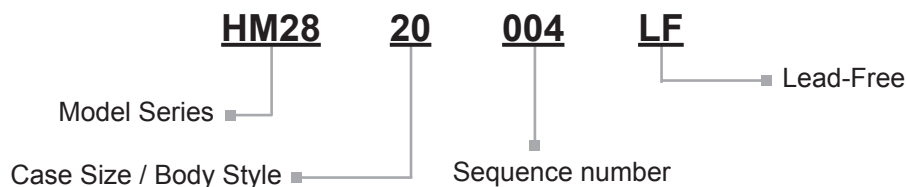

Outline Dimensions (mm)

Figure 1

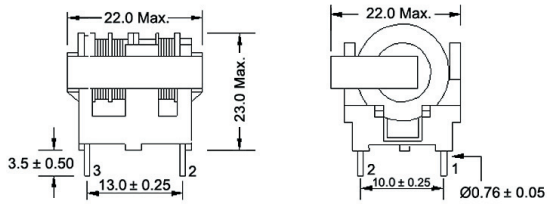

Figure 2

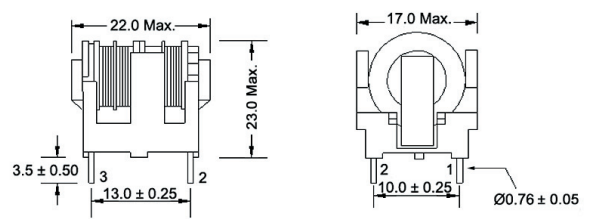

Figure 3

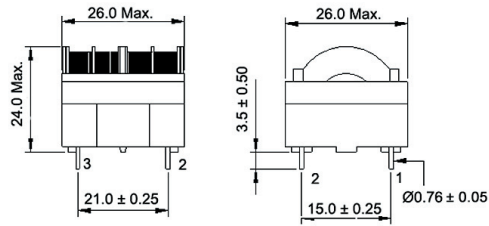

Figure 4

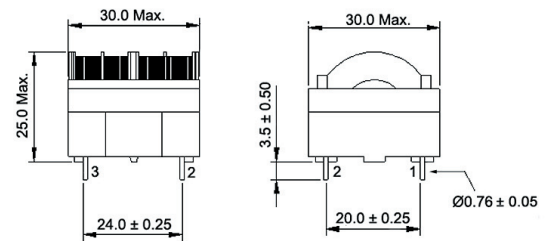

Figure 5

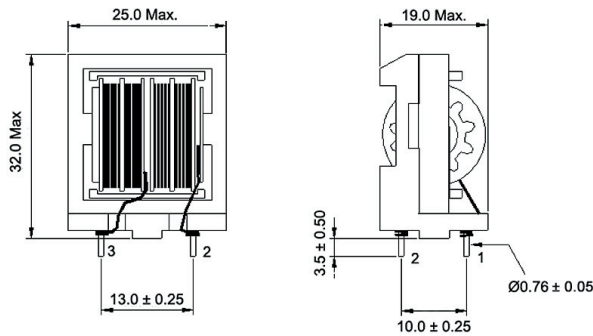

Figure 6

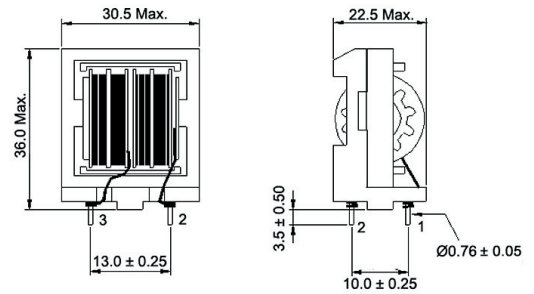

Figure 7

