

MITSUBISHI IGBT MODULES
CM200DU-34KA

HIGH POWER SWITCHING USE

CM200DU-34KA



- IC200A
- VCES 1700V
- Insulated Type
- 2-elements in a pack

APPLICATION

General purpose inverters & Servo controls, etc

OUTLINE DRAWING & CIRCUIT DIAGRAM

Dimensions in mm

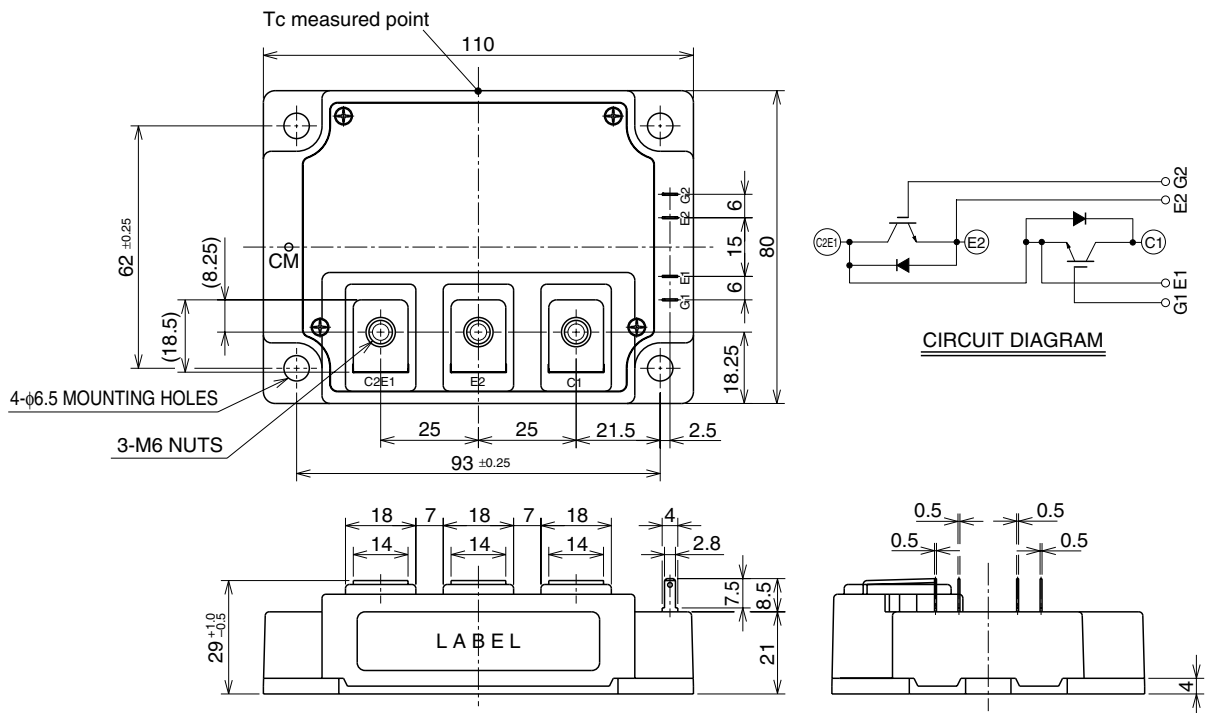

CM200DU-34KA

HIGH POWER SWITCHING USE

MAXIMUM RATINGS (T_j = 25°C)

Symbol	Parameter	Conditions	Ratings	Unit
V _{CE} S	Collector-emitter voltage	G-E Short	1700	V
V _{GE} S	Gate-emitter voltage	C-E Short	±20	V
I _C	Collector current	T _c = 25°C	200	A
I _{CM}		Pulse (Note 2)	400	
I _E (Note 1)	Emitter current	T _c = 25°C	200	A
I _{EM} (Note 1)		Pulse (Note 2)	400	
P _C (Note 3)	Maximum collector dissipation	T _c = 25°C	1100	W
T _j	Junction temperature		-40 ~ +150	°C
T _{stg}	Storage temperature		-40 ~ +125	°C
V _{iso}	Isolation voltage	Main terminal to base plate, AC 1 min.	3500	V
—	Torque strength	Main Terminal M6	3.5 ~ 4.5	N • m
		Mounting holes M6	3.5 ~ 4.5	N • m
—	Weight	Typical value	580	g

ELECTRICAL CHARACTERISTICS (T_j = 25°C)

Symbol	Parameter	Test conditions	Limits			Unit
			Min.	Typ.	Max.	
I _{CE} S	Collector cutoff current	V _{CE} = V _{CE} S, V _{GE} = 0V	—	—	1	mA
V _{GE(th)}	Gate-emitter threshold voltage	I _C = 20mA, V _{CE} = 10V	4	5.5	7	V
I _{GE} S	Gate leakage current	V _{GE} = V _{GE} S, V _{CE} = 0V	—	—	0.5	µA
V _{CE(sat)}	Collector-emitter saturation voltage	T _j = 25°C	—	3.2	4.0	V
		T _j = 125°C	—	3.8	—	
C _{ies}	Input capacitance	V _{CE} = 10V V _{GE} = 0V	—	—	29	nF
C _{oes}	Output capacitance		—	—	4.8	
C _{res}	Reverse transfer capacitance		—	—	1.5	
Q _G	Total gate charge	V _{CC} = 1000V, I _C = 200A, V _{GE} = 15V	—	900	—	nC
t _{d(on)}	Turn-on delay time	V _{CC} = 1000V, I _C = 200A V _{GE1} = V _{GE2} = 15V R _G = 1.6Ω, Inductive load switching operation I _E = 200A	—	—	600	ns
t _r	Turn-on rise time		—	—	200	
t _{d(off)}	Turn-off delay time		—	—	700	
t _f	Turn-off fall time		—	—	800	
t _{rr} (Note 1)	Reverse recovery time		—	—	600	
Q _{rr} (Note 1)	Reverse recovery charge	—	9.6	—	µC	
V _{EC} (Note 1)	Emitter-collector voltage	I _E = 200A, V _{GE} = 0V, T _j = 25°C	—	—	4.6	V
		I _E = 200A, V _{GE} = 0V, T _j = 125°C	—	2.2	—	V
R _{th(j-c)Q}	Thermal resistance*1	IGBT part (1/2 module)	—	—	0.11	°C/W
R _{th(j-c)R}		FWDi part (1/2 module)	—	—	0.18	
R _{th(c-f)}	Contact thermal resistance	Case to fin, Thermal compound applied*2 (1/2 module)	—	0.02	—	
R _{th(j-c)Q}	Thermal resistance	T _c measured point is just under the chips	—	—	0.05*3	

Note 1. I_E, V_{EC}, t_{rr}, Q_{rr}, die/dt represent characteristics of the anti-parallel, emitter to collector free-wheel diode. (FWDi).

2. Pulse width and repetition rate should be such that the device junction temp. (T_j) does not exceed T_{jmax} rating.

3. Junction temperature (T_j) should not increase beyond 150°C.

4. Pulse width and repetition rate should be such as to cause negligible temperature rise.

*1 : T_c measured point is indicated in OUTLINE DRAWING.

*2 : Typical value is measured by using Shin-etsu Silicone "G-746".

*3 : If you use this value, R_{th(f-a)} should be measured just under the chips.

PERFORMANCE CURVES

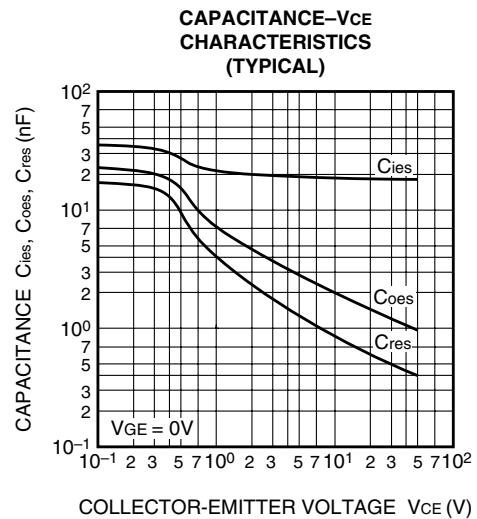
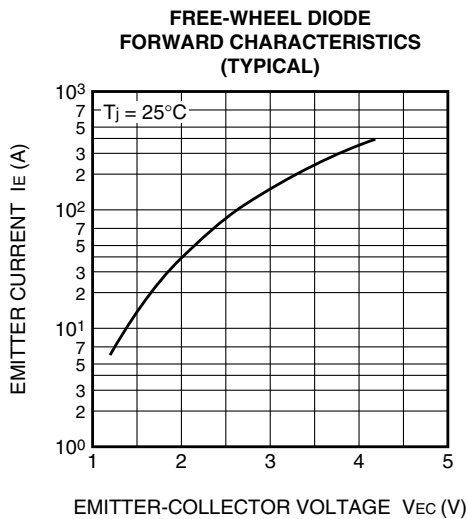
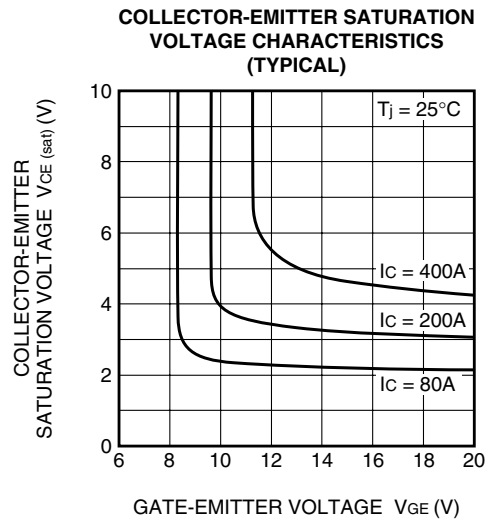
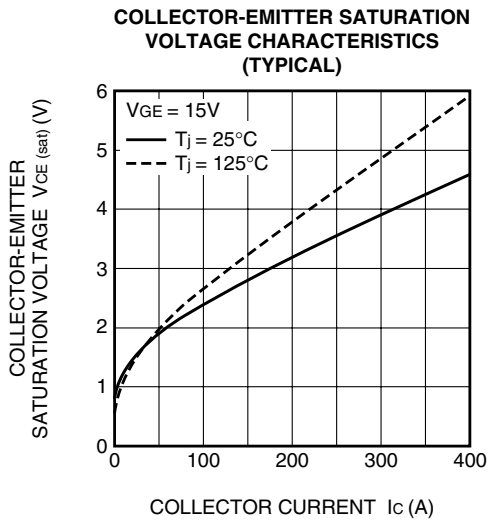
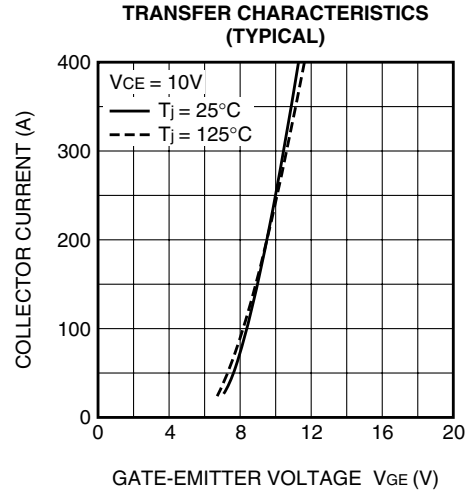
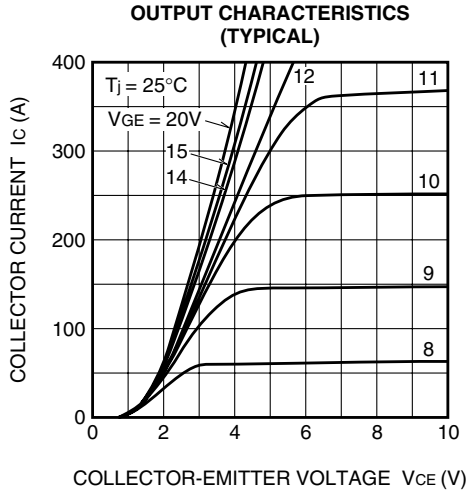

CM200DU-34KA

HIGH POWER SWITCHING USE

HALF-BRIDGE SWITCHING CHARACTERISTICS (TYPICAL)

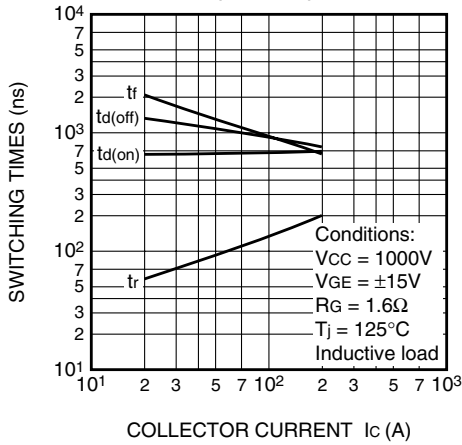

REVERSE RECOVERY CHARACTERISTICS OF FREE-WHEEL DIODE (TYPICAL)

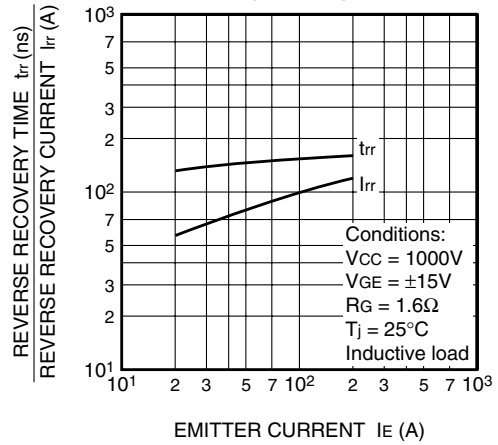

TRANSIENT THERMAL IMPEDANCE CHARACTERISTICS (IGBT part & FWDi part)

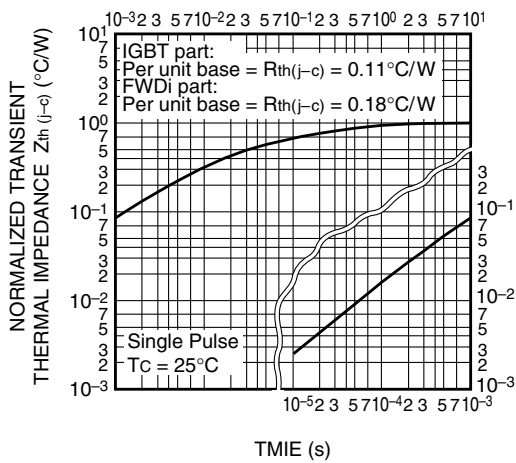

GATE CHARGE CHARACTERISTICS (TYPICAL)

