

LEGEND:

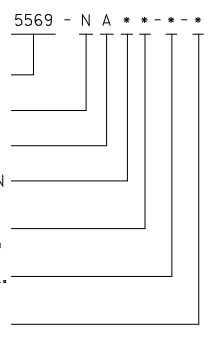

CIRCUIT SIZE	DIM. "A"	DIM. "B"
6	.54 (13.8)	.33 (8.4)
8	.71 (18.0)	.50 (12.6)
10	.87 (22.2)	.66 (16.8)
12	1.04 (26.4)	.83 (21.0)
14	1.20 (30.6)	.99 (25.2)
16	1.37 (34.8)	1.16 (29.4)
18	1.54 (39.0)	1.32 (33.6)
20	1.70 (43.2)	1.49 (37.8)
22	1.87 (47.4)	1.65 (42.0)
24	2.03 (51.6)	1.82 (46.2)

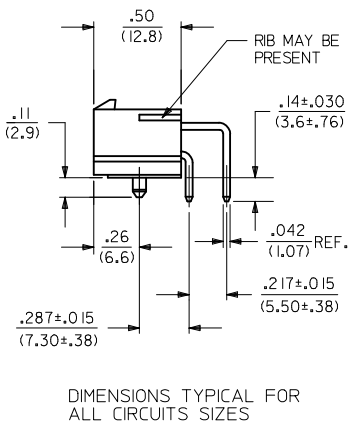

DIMENSIONS TYPICAL FOR ALL CIRCUIT SIZES

- NOTES:**
- MATERIAL:**
HOUSING:
"BLANK" = NYLON (PA66), UNFILLED, UL94V-2, COLOR: NATURAL
"BL" = NYLON (PA66), UNFILLED, UL94V-2, COLOR: BLACK
"210" = NYLON (PA66), UNFILLED, UL94V-0, COLOR: NATURAL
"400" = NYLON (PA66), UNFILLED, UL94V-0, COLOR: BLACK
TERMINAL:
BRASS ALLOY
 - FINISH (PLATING):**
"BLANK" = .000200/(0.00508) MIN. BRIGHT TIN OVER
.000100/(0.00254) MIN. COPPER
G = .000030/(0.00076) MIN. GOLD OVER
.000050/(0.00127) MIN. NICKEL
G2 = .000015/(0.00038) MIN. GOLD OVER
.000030/(0.00076) MIN. NICKEL
G3 = .000050/(0.00127) MIN. GOLD OVER
.000050/(0.00127) MIN. NICKEL
GS = .000030/(0.00076) MIN. SELECT GOLD OVER
.000100/(0.00254) MIN. SELECT MATTE TIN OVER
.000050/(0.00127) MIN. NICKEL OVERALL
GS2 = .000015/(0.00038) MIN. SELECT GOLD OVER
.000100/(0.00254) MIN. SELECT MATTE TIN OVER
.000050/(0.00127) MIN. NICKEL OVERALL
GS3 = .000050/(0.00127) MIN. SELECT GOLD OVER
.000100/(0.00254) MIN. SELECT MATTE TIN OVER
.000050/(0.00127) MIN. NICKEL OVERALL
S = .000100/(0.00254) MIN. BRIGHT TIN OVER
.000050/(0.00127) MIN. NICKEL
RM = .000060/(0.00152) MIN. REFLOWED MATTE TIN OVER
.000050/(0.00127) MIN. NICKEL OVERALL
 - PRODUCT SPECIFICATION: PS-5556-001
 - PACKAGING:
"BLANK" = BULK PACKED PER PK-5569-002
"T" = TRAY PACKED PER PK-5569-003
 - PART MATES WITH MINI-FIT JR. RECEPTACLE SERIES 5557.
 - MOUNTING OPTIONS:
1 = SCREW MOUNT (SEE SD-5569-NA* SERIES DRAWING)
2 = PEG MOUNT
 - DISCOLORATION IN THE BANDOLIER CARRIER AREA OF THE PIN IS INHERENT TO THE PLATING PROCESS AND IS DUE TO THE MASKING EFFECT OF THE CARRIER. THIS DISCOLORATION IS IN A NON-FUNCTIONAL AREA OF THE PIN AND WILL NOT AFFECT THE PERFORMANCE OF THE HEADER ASSEMBLY.
 - PART CONFORMS TO CLASS "B" REQUIREMENTS OF COSMETIC SPECIFICATION PS-45499-002.
 - CONNECTORS ARE NOT TO BE MATED AND UNMATED WHILE CIRCUITS ARE LIVE.
 - PARTS ARE NOT DESIGNED FOR CURRENT SHARING.

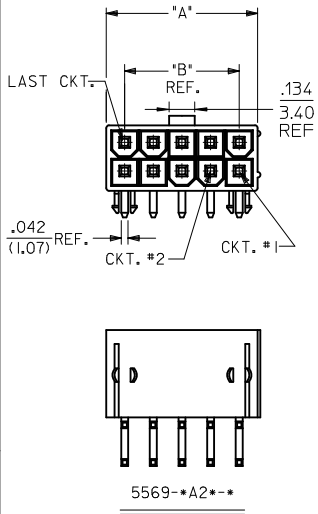

5569-A2**

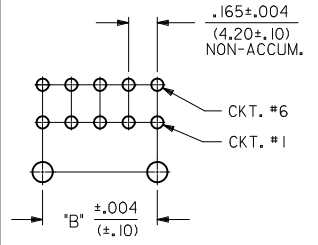

RECOMMENDED HOLE LAYOUT FOR .070/(1.78) MAX. THICK P.C. BOARD VIEWED FROM COMPONENT SIDE

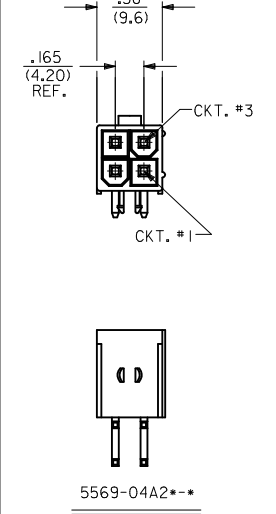

5569-04A2**

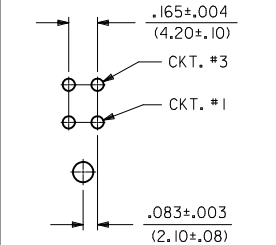

RECOMMENDED HOLE LAYOUT FOR .070/(1.78) MAX. THICK P.C. BOARD VIEWED FROM COMPONENT SIDE

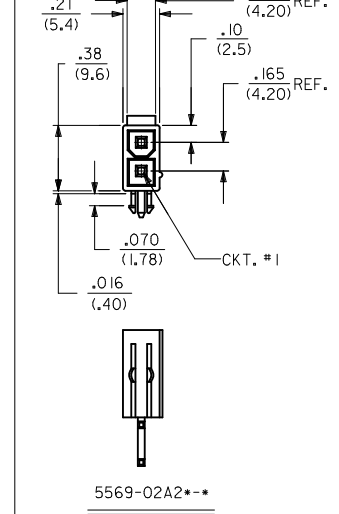

5569-02A2**

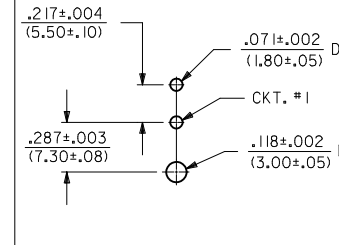

RECOMMENDED HOLE LAYOUT FOR .070/(1.78) MAX. THICK P.C. BOARD VIEWED FROM COMPONENT SIDE

DIMENSIONS IN THIS VIEW ARE TYPICAL FOR CIRCUIT SIZES 6 THRU 24

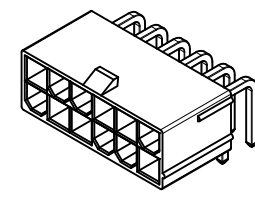

2-6	GENERAL DOCS.	L6
1	MEIO	L7
SHT.	SOFTWARE	REV.

ADD CKT DIM NOTES EC NO: UCP2011-2965 DRWNG: JAGUILAR 2011/03/28 CHKD: JEBELL 2011/03/28 APPR: FSMITH 2011/04/04	QUALITY SYMBOLS ∇=0 ∇=0 ∇=0	GENERAL TOLERANCES (UNLESS SPECIFIED)		DIMENSION STYLE IN/MM		SCALE 2:1	DESIGN UNITS METRIC		THIRD ANGLE PROJECTION												
		<table border="1"> <tr> <th>mm</th> <th>INCH</th> </tr> <tr> <td>4 PLACES ± ---</td> <td>± ---</td> </tr> <tr> <td>3 PLACES ± ---</td> <td>± .010</td> </tr> <tr> <td>2 PLACES ± .25</td> <td>± .015</td> </tr> <tr> <td>1 PLACE ± .38</td> <td>± ---</td> </tr> </table>		mm	INCH	4 PLACES ± ---	± ---	3 PLACES ± ---	± .010	2 PLACES ± .25	± .015	1 PLACE ± .38	± ---	DRAWN BY RJF		DATE 1988/02/16		TITLE MINI-FIT JR RIGHT ANGLE HEADER ASSEMBLIES WITH MOUNTING PEGS			
		mm	INCH																		
		4 PLACES ± ---	± ---																		
3 PLACES ± ---	± .010																				
2 PLACES ± .25	± .015																				
1 PLACE ± .38	± ---																				
ANGULAR ±1/2°		CHECKED BY GT		DATE 1988/02/16																	
DRAFT WHERE APPLICABLE MUST REMAIN WITHIN DIMENSIONS		APPROVED BY FSMITH		DATE 2010/12/06		MOLEX INCORPORATED		DOCUMENT NO. SDA-5569-NA2*-**		SHEET NO. 1 OF 6											
THIS DRAWING CONTAINS INFORMATION THAT IS PROPRIETARY TO MOLEX INCORPORATED AND SHOULD NOT BE USED WITHOUT WRITTEN PERMISSION																					

BULK PACKAGED PER PK-5569-002

PART NUMBER	ENG. NUMBER	CKT. SIZE	PLATING (NOTE 2)	HSG MAT'L	PART NUMBER	ENG. NUMBER	CKT. SIZE	PLATING (NOTE 2)	HSG MAT'L
39-30-1020	5569-02A2	2	TIN OVER COPPER SEE NOTE 2 OPTION "BLANK"	94V-2	39-30-0020	5569-02A2-210	2	TIN OVER COPPER SEE NOTE 2 OPTION "BLANK"	94V-0
39-30-1040	5569-04A2	4			39-30-0040	5569-04A2-210	4		
39-30-1060	5569-06A2	6			39-30-0060	5569-06A2-210	6		
39-30-1080	5569-08A2	8			39-30-0080	5569-08A2-210	8		
39-30-1100	5569-10A2	10			39-30-0100	5569-10A2-210	10		
39-30-1120	5569-12A2	12			39-30-0120	5569-12A2-210	12		
39-30-1140	5569-14A2	14			39-30-0140	5569-14A2-210	14		
39-30-1160	5569-16A2	16			39-30-0160	5569-16A2-210	16		
39-30-1180	5569-18A2	18			39-30-0180	5569-18A2-210	18		
39-30-1200	5569-20A2	20			39-30-0200	5569-20A2-210	20		
39-30-1220	5569-22A2	22			39-30-0220	5569-22A2-210	22		
39-30-1240	5569-24A2	24			39-30-0240	5569-24A2-210	24		

39-30-1021	5569-02A2G	2	30 μ" GOLD SEE NOTE 2 OPTION "G"	94V-2	39-30-1022	5569-02A2G-210	2	30 μ" GOLD SEE NOTE 2 OPTION "G"	94V-0
39-30-1041	5569-04A2G	4			39-30-1042	5569-04A2G-210	4		
39-30-1061	5569-06A2G	6			39-30-1062	5569-06A2G-210	6		
39-30-1081	5569-08A2G	8			39-30-1082	5569-08A2G-210	8		
39-30-1101	5569-10A2G	10			39-30-1102	5569-10A2G-210	10		
39-30-1121	5569-12A2G	12			39-30-1122	5569-12A2G-210	12		
39-30-1141	5569-14A2G	14			39-30-1142	5569-14A2G-210	14		
39-30-1161	5569-16A2G	16			39-30-1162	5569-16A2G-210	16		
39-30-1181	5569-18A2G	18			39-30-1182	5569-18A2G-210	18		
39-30-1201	5569-20A2G	20			39-30-1202	5569-20A2G-210	20		
39-30-1221	5569-22A2G	22			39-30-1222	5569-22A2G-210	22		
39-30-1241	5569-24A2G	24			39-30-1242	5569-24A2G-210	24		

39-30-0021	5569-02A2G2	2	15 μ" GOLD SEE NOTE 2 OPTION "G2"	94V-2	39-30-0022	5569-02A2G2-210	2	15 μ" GOLD SEE NOTE 2 OPTION "G2"	94V-0
39-30-0041	5569-04A2G2	4			39-30-0042	5569-04A2G2-210	4		
39-30-0061	5569-06A2G2	6			39-30-0062	5569-06A2G2-210	6		
39-30-0081	5569-08A2G2	8			39-30-0082	5569-08A2G2-210	8		
39-30-0101	5569-10A2G2	10			39-30-0102	5569-10A2G2-210	10		
39-30-0121	5569-12A2G2	12			39-30-0122	5569-12A2G2-210	12		
39-30-0141	5569-14A2G2	14			39-30-0142	5569-14A2G2-210	14		
39-30-0161	5569-16A2G2	16			39-30-0162	5569-16A2G2-210	16		
39-30-0181	5569-18A2G2	18			39-30-0182	5569-18A2G2-210	18		
39-30-0201	5569-20A2G2	20			39-30-0202	5569-20A2G2-210	20		
39-30-0221	5569-22A2G2	22			39-30-0222	5569-22A2G2-210	22		
39-30-0241	5569-24A2G2	24			39-30-0242	5569-24A2G2-210	24		

NOT TOOLED	5569-02A2G3	2	50 μ" GOLD SEE NOTE 2 OPTION "G3"	94V-2	NOT TOOLED	5569-02A2G3-210	2	50 μ" GOLD SEE NOTE 2 OPTION "G3"	94V-0
15-27-1514	5569-04A2G3	4			NOT TOOLED	5569-04A2G3-210	4		
15-27-1511	5569-06A2G3	6			NOT TOOLED	5569-06A2G3-210	6		
15-27-1512	5569-08A2G3	8			NOT TOOLED	5569-08A2G3-210	8		
15-27-1503	5569-10A2G3	10			15-27-1504	5569-10A2G3-210	10		
NOT TOOLED	5569-12A2G3	12			NOT TOOLED	5569-12A2G3-210	12		
NOT TOOLED	5569-14A2G3	14			NOT TOOLED	5569-14A2G3-210	14		
15-27-1513	5569-16A2G3	16			NOT TOOLED	5569-16A2G3-210	16		
NOT TOOLED	5569-18A2G3	18			NOT TOOLED	5569-18A2G3-210	18		
NOT TOOLED	5569-20A2G3	20			NOT TOOLED	5569-20A2G3-210	20		
NOT TOOLED	5569-22A2G3	22			NOT TOOLED	5569-22A2G3-210	22		
NOT TOOLED	5569-24A2G3	24			NOT TOOLED	5569-24A2G3-210	24		

REVISION: L6	ECR/ECN INFORMATION: EC No: UCP2010-1417 DATE: 2010/11/30	TITLE: MINI-FIT JR.® RIGHT ANGLE HEADER ASSEMBLIES WITH MOUNTING PEGS	SHEET No. - 2 -
----------------------------	---	---	------------------------

DOCUMENT NUMBER: SDA-5569-NA2*-*	Drawn By: JJAGUILAR	Checked By: JBELL	Approved By: FSMITH
--	-------------------------------	-----------------------------	-------------------------------

BULK PACKAGED PK-5569-002

PART NUMBER	ENG. NUMBER	CKT. SIZE	PLATING (NOTE 2)	HSG MAT'L	PART NUMBER	ENG. NUMBER	CKT. SIZE	PLATING (NOTE 2)	HSG MAT'L
39-30-0023	5569-02A2GS	2	30 μ" SELECT GOLD SEE NOTE 2 OPTION "GS"	94V-2	39-30-0024	5569-02A2GS-210	2	30 μ" SELECT GOLD SEE NOTE 2 OPTION "GS"	94V-0
39-30-0043	5569-04A2GS	4			39-30-0044	5569-04A2GS-210	4		
39-30-0063	5569-06A2GS	6			39-30-0064	5569-06A2GS-210	6		
39-30-0083	5569-08A2GS	8			39-30-0084	5569-08A2GS-210	8		
39-30-0103	5569-10A2GS	10			39-30-0104	5569-10A2GS-210	10		
39-30-0123	5569-12A2GS	12			39-30-0124	5569-12A2GS-210	12		
39-30-0143	5569-14A2GS	14			39-30-0144	5569-14A2GS-210	14		
39-30-0163	5569-16A2GS	16			39-30-0164	5569-16A2GS-210	16		
39-30-0183	5569-18A2GS	18			39-30-0184	5569-18A2GS-210	18		
39-30-0203	5569-20A2GS	20			39-30-0204	5569-20A2GS-210	20		
39-30-0223	5569-22A2GS	22			39-30-0224	5569-22A2GS-210	22		
39-30-0243	5569-24A2GS	24			39-30-0244	5569-24A2GS-210	24		

39-30-1023	5569-02A2GS2	2	15 μ" SELECT GOLD SEE NOTE 2 OPTION "GS2"	94V-2	39-30-1024	5569-02A2GS2-210	2	15 μ" SELECT GOLD SEE NOTE 2 OPTION "GS2"	94V-0
39-30-1043	5569-04A2GS2	4			39-30-1044	5569-04A2GS2-210	4		
39-30-1063	5569-06A2GS2	6			39-30-1064	5569-06A2GS2-210	6		
39-30-1083	5569-08A2GS2	8			39-30-1084	5569-08A2GS2-210	8		
39-30-1103	5569-10A2GS2	10			39-30-1104	5569-10A2GS2-210	10		
39-30-1123	5569-12A2GS2	12			39-30-1124	5569-12A2GS2-210	12		
39-30-1143	5569-14A2GS2	14			39-30-1144	5569-14A2GS2-210	14		
39-30-1163	5569-16A2GS2	16			39-30-1164	5569-16A2GS2-210	16		
39-30-1183	5569-18A2GS2	18			39-30-1184	5569-18A2GS2-210	18		
39-30-1203	5569-20A2GS2	20			39-30-1204	5569-20A2GS2-210	20		
39-30-1223	5569-22A2GS2	22			39-30-1224	5569-22A2GS2-210	22		
39-30-1243	5569-24A2GS2	24			39-30-1244	5569-24A2GS2-210	24		

39-34-4026	5569-02A2GS3	2	50 μ" SELECT GOLD SEE NOTE 2 OPTION "GS3"	94V-2	39-34-4027	5569-02A2GS3-210	2	50 μ" SELECT GOLD SEE NOTE 2 OPTION "GS3"	94V-0
39-34-4046	5569-04A2GS3	4			39-34-4047	5569-04A2GS3-210	4		
NOT TOOLED	5569-06A2GS3	6			NOT TOOLED	5569-06A2GS3-210	6		
NOT TOOLED	5569-08A2GS3	8			NOT TOOLED	5569-08A2GS3-210	8		
NOT TOOLED	5569-10A2GS3	10			NOT TOOLED	5569-10A2GS3-210	10		
NOT TOOLED	5569-12A2GS3	12			NOT TOOLED	5569-12A2GS3-210	12		
NOT TOOLED	5569-14A2GS3	14			NOT TOOLED	5569-14A2GS3-210	14		
NOT TOOLED	5569-16A2GS3	16			NOT TOOLED	5569-16A2GS3-210	16		
NOT TOOLED	5569-18A2GS3	18			NOT TOOLED	5569-18A2GS3-210	18		
NOT TOOLED	5569-20A2GS3	20			NOT TOOLED	5569-20A2GS3-210	20		
NOT TOOLED	5569-22A2GS3	22			NOT TOOLED	5569-22A2GS3-210	22		
NOT TOOLED	5569-24A2GS3	24			NOT TOOLED	5569-24A2GS3-210	24		

39-30-7025	5569-02A2S	2	TIN OVER NICKEL SEE NOTE 2 OPTION "S"	94V-2	39-30-7026	5569-02A2S-210	2	TIN OVER NICKEL SEE NOTE 2 OPTION "S"	94V-0
39-30-7045	5569-04A2S	4			39-30-7046	5569-04A2S-210	4		
39-30-7065	5569-06A2S	6			39-30-7066	5569-06A2S-210	6		
39-30-7085	5569-08A2S	8			39-30-7086	5569-08A2S-210	8		
39-30-7105	5569-10A2S	10			39-30-7106	5569-10A2S-210	10		
39-30-7125	5569-12A2S	12			39-30-7126	5569-12A2S-210	12		
39-30-7145	5569-14A2S	14			39-30-7146	5569-14A2S-210	14		
39-30-7165	5569-16A2S	16			39-30-7166	5569-16A2S-210	16		
39-30-7185	5569-18A2S	18			39-30-7186	5569-18A2S-210	18		
39-30-7205	5569-20A2S	20			39-30-7206	5569-20A2S-210	20		
39-30-7225	5569-22A2S	22			39-30-7226	5569-22A2S-210	22		
39-30-7245	5569-24A2S	24			39-30-7246	5569-24A2S-210	24		

REVISION: L6	ECR/ECN INFORMATION: EC No: UCP2010-1417 DATE: 2010/11/30	TITLE: MINI-FIT JR.® RIGHT ANGLE HEADER ASSEMBLIES WITH MOUNTING PEGS	SHEET No. - 3 -
----------------------------	---	---	------------------------

DOCUMENT NUMBER: SDA-5569-NA2*-*	Drawn By: JJAGUILAR	Checked By: JBELL	Approved By: FSMITH
--	-------------------------------	-----------------------------	-------------------------------

BULK PACKAGED PER PK-5569-002

PART NUMBER	ENG. NUMBER	CKT. SIZE	PLATING (NOTE 2)	HSG MAT'L	PART NUMBER	ENG. NUMBER	CKT. SIZE	PLATING (NOTE 2)	HSG MAT'L
		2			39-31-1021	5569-02A2-BL	2	TIN OVER COPPER SEE NOTE 2 OPTION "BLANK"	BLACK 94V-2
		4			39-31-1041	5569-04A2-BL	4		
		6			39-31-1061	5569-06A2-BL	6		
		8			39-31-1081	5569-08A2-BL	8		
		10			39-31-1101	5569-10A2-BL	10		
		12			39-31-1121	5569-12A2-BL	12		
		14			39-31-1141	5569-14A2-BL	14		
		16			39-31-1161	5569-16A2-BL	16		
		18			39-31-1181	5569-18A2-BL	18		
		20			39-31-1201	5569-20A2-BL	20		
		22			39-31-1221	5569-22A2-BL	22		
		24			39-31-1241	5569-24A2-BL	24		

		2			39-31-6029	5569-02A2G-BL	2	30 μ" GOLD SEE NOTE 2 OPTION "G"	BLACK 94V-2
		4			39-31-6049	5569-04A2G-BL	4		
		6			39-31-6069	5569-06A2G-BL	6		
		8			39-31-6089	5569-08A2G-BL	8		
		10			39-31-6109	5569-10A2G-BL	10		
		12			39-31-6129	5569-12A2G-BL	12		
		14			39-31-6149	5569-14A2G-BL	14		
		16			39-31-6169	5569-16A2G-BL	16		
		18			39-31-6189	5569-18A2G-BL	18		
		20			39-31-6209	5569-20A2G-BL	20		
		22			39-31-6229	5569-22A2G-BL	22		
		24			39-31-6249	5569-24A2G-BL	24		

		2							
		4							
		6							
		8							
		10							
		12							
		14							
		16							
		18							
		20							
		22							
		24							

39-34-9021	5569-02A2S-400	2	TIN OVER NICKEL SEE NOTE 2 OPTION "S"	BLACK 94V-0						
39-34-9041	5569-04A2S-400	4								
39-34-9061	5569-06A2S-400	6								
39-34-9081	5569-08A2S-400	8								
39-34-9101	5569-10A2S-400	10								
39-34-9121	5569-12A2S-400	12								
39-34-9141	5569-14A2S-400	14								
39-34-9161	5569-16A2S-400	16								
39-34-9181	5569-18A2S-400	18								
39-34-9201	5569-20A2S-400	20								
39-34-9221	5569-22A2S-400	22								
39-34-9241	5569-24A2S-400	24								

REVISION: L6	ECR/ECN INFORMATION: EC No: UCP2010-1417 DATE: 2010/11/30	TITLE: MINI-FIT JR.® RIGHT ANGLE HEADER ASSEMBLIES WITH MOUNTING PEGS	SHEET No. - 4 -
----------------------------	---	---	------------------------

DOCUMENT NUMBER: SDA-5569-NA2*-*	Drawn By: JJAGUILAR	Checked By: JBELL	Approved By: FSMITH
--	-------------------------------	-----------------------------	-------------------------------

TRAY PACKAGED PER PK-5569-003					BULK PACKAGED PER PK-5569-002				
PART NUMBER	ENG. NUMBER	CKT. SIZE	PLATING (NOTE 2)	HSG MAT'L	PART NUMBER	ENG. NUMBER	CKT. SIZE	PLATING (NOTE 2)	HSG MAT'L
46999-0061	5569-02A2RM-T	2	TIN OVER NICKEL SEE NOTE 2 OPTION "RM"	94V-2	39-31-9029	5569-02A2S-BL	2	TIN OVER NICKEL SEE NOTE 2 OPTION "S"	BLACK 94V-2
46999-0062	5569-04A2RM-T	4			39-31-9049	5569-04A2S-BL	4		
46999-0063	5569-06A2RM-T	6			39-31-9069	5569-06A2S-BL	6		
46999-0064	5569-08A2RM-T	8			39-31-9089	5569-08A2S-BL	8		
46999-0065	5569-10A2RM-T	10			39-31-9109	5569-10A2S-BL	10		
46999-0066	5569-12A2RM-T	12			39-31-9129	5569-12A2S-BL	12		
46999-0067	5569-14A2RM-T	14			39-31-9149	5569-14A2S-BL	14		
46999-0068	5569-16A2RM-T	16			39-31-9169	5569-16A2S-BL	16		
46999-0069	5569-18A2RM-T	18			39-31-9189	5569-18A2S-BL	18		
46999-0070	5569-20A2RM-T	20			39-31-9209	5569-20A2S-BL	20		
46999-0071	5569-22A2RM-T	22			39-31-9229	5569-22A2S-BL	22		
46999-0072	5569-24A2RM-T	24			39-31-9249	5569-24A2S-BL	24		

46999-0073	5569-02A2RM-210-T	2	TIN OVER NICKEL SEE NOTE 2 OPTION "RM"	94V-0						
46999-0074	5569-04A2RM-210-T	4								
46999-0075	5569-06A2RM-210-T	6								
46999-0076	5569-08A2RM-210-T	8								
46999-0077	5569-10A2RM-210-T	10								
46999-0078	5569-12A2RM-210-T	12								
46999-0079	5569-14A2RM-210-T	14								
46999-0080	5569-16A2RM-210-T	16								
46999-0081	5569-18A2RM-210-T	18								
46999-0082	5569-20A2RM-210-T	20								
46999-0083	5569-22A2RM-210-T	22								
46999-0084	5569-24A2RM-210-T	24								

REVISION: L6	ECR/ECN INFORMATION: EC No: UCP2010-1417 DATE: 2010/11/30	TITLE: MINI-FIT JR.® RIGHT ANGLE HEADER ASSEMBLIES WITH MOUNTING PEGS	SHEET No. - 5 -
-----------------------------------	--	--	-------------------------------

DOCUMENT NUMBER: SDA-5569-NA2*-*	Drawn By: JJAGUILAR	Checked By: JBELL	Approved By: FSMITH
---	--------------------------------------	------------------------------------	--------------------------------------

TRAY PACKAGED PER PK-5569-003

PART NUMBER	ENG. NUMBER	CKT. SIZE	PLATING (NOTE 2)	HSG MAT'L	PART NUMBER	ENG. NUMBER	CKT. SIZE	PLATING (NOTE 2)	HSG MAT'L	
26-01-3127	5569-02A2GS2-210-T	2	15 μ" SELECT GOLD SEE NOTE 2 OPTION "GS2"	94V-0			2			
26-01-3128	5569-04A2GS2-210-T	4						4		
NOT TOOLED	5569-06A2GS2-210-T	6						6		
NOT TOOLED	5569-08A2GS2-210-T	8						8		
NOT TOOLED	5569-10A2GS2-210-T	10						10		
NOT TOOLED	5569-12A2GS2-210-T	12						12		
NOT TOOLED	5569-14A2GS2-210-T	14						14		
NOT TOOLED	5569-16A2GS2-210-T	16						16		
NOT TOOLED	5569-18A2GS2-210-T	18						18		
NOT TOOLED	5569-20A2GS2-210-T	20						20		
NOT TOOLED	5569-22A2GS2-210-T	22						22		
NOT TOOLED	5569-24A2GS2-210-T	24						24		

26-01-3141	5569-02A2GS3-T	2	50 μ" SELECT GOLD SEE NOTE 2 OPTION "GS3"	94V-2			2			
26-01-3142	5569-04A2GS3-T	4						4		
26-01-3143	5569-06A2GS3-T	6						6		
26-01-3144	5569-08A2GS3-T	8						8		
NOT TOOLED	5569-10A2GS3-T	10						10		
NOT TOOLED	5569-12A2GS3-T	12						12		
NOT TOOLED	5569-14A2GS3-T	14						14		
26-01-3148	5569-16A2GS3-T	16						16		
NOT TOOLED	5569-18A2GS3-T	18						18		
NOT TOOLED	5569-20A2GS3-T	20						20		
NOT TOOLED	5569-22A2GS3-T	22						22		
NOT TOOLED	5569-24A2GS3-T	24						24		

46999-0001	5569-02A2S-BL-T	2	TIN OVER NICKEL SEE NOTE 2 OPTION "S"	BLACK 94V-2			2			
46999-0002	5569-04A2S-BL-T	4						4		
46999-0003	5569-06A2S-BL-T	6						6		
46999-0004	5569-08A2S-BL-T	8						8		
46999-0005	5569-10A2S-BL-T	10						10		
46999-0006	5569-12A2S-BL-T	12						12		
46999-0007	5569-14A2S-BL-T	14						14		
46999-0008	5569-16A2S-BL-T	16						16		
46999-0009	5569-18A2S-BL-T	18						18		
46999-0010	5569-20A2S-BL-T	20						20		
46999-0011	5569-22A2S-BL-T	22						22		
46999-0012	5569-24A2S-BL-T	24						24		

46999-0013	5569-02A2S-400-T	2	TIN OVER NICKEL SEE NOTE 2 OPTION "S"	BLACK 94V-0			2			
46999-0014	5569-04A2S-400-T	4						4		
46999-0015	5569-06A2S-400-T	6						6		
46999-0016	5569-08A2S-400-T	8						8		
46999-0017	5569-10A2S-400-T	10						10		
46999-0018	5569-12A2S-400-T	12						12		
46999-0019	5569-14A2S-400-T	14						14		
46999-0020	5569-16A2S-400-T	16						16		
46999-0021	5569-18A2S-400-T	18						18		
46999-0022	5569-20A2S-400-T	20						20		
46999-0023	5569-22A2S-400-T	22						22		
46999-0024	5569-24A2S-400-T	24						24		

REVISION: L6	ECR/ECN INFORMATION: EC No: UCP2010-1417 DATE: 2010/11/30	TITLE: MINI-FIT JR.® RIGHT ANGLE HEADER ASSEMBLIES WITH MOUNTING PEGS	SHEET No. - 6 -
---------------------	---	---	-------------------------------

DOCUMENT NUMBER: SDA-5569-NA2*-*	Drawn By: JJAGUILAR	Checked By: JBELL	Approved By: FSMITH
--	-------------------------------	-----------------------------	-------------------------------

TRAY PACKAGED PER PK-5569-003

PART NUMBER	ENG. NUMBER	CKT. SIZE	PLATING (NOTE 2)	HSG MAT'L	PART NUMBER	ENG. NUMBER	CKT. SIZE	PLATING (NOTE 2)	HSG MAT'L
50-36-1757	5569-02A2S-T	2	TIN OVER NICKEL SEE NOTE 2 OPTION "S"	94V-2	50-36-1758	5569-02A2S-210-T	2	TIN OVER NICKEL SEE NOTE 2 OPTION "S"	94V-0
50-36-1767	5569-04A2S-T	4			50-36-1768	5569-04A2S-210-T	4		
50-36-1777	5569-06A2S-T	6			50-36-1778	5569-06A2S-210-T	6		
50-36-1787	5569-08A2S-T	8			50-36-1788	5569-08A2S-210-T	8		
50-36-1797	5569-10A2S-T	10			50-36-1798	5569-10A2S-210-T	10		
50-36-1807	5569-12A2S-T	12			50-36-1808	5569-12A2S-210-T	12		
50-36-1817	5569-14A2S-T	14			50-36-1818	5569-14A2S-210-T	14		
50-36-1827	5569-16A2S-T	16			50-36-1828	5569-16A2S-210-T	16		
50-36-1837	5569-18A2S-T	18			50-36-1838	5569-18A2S-210-T	18		
50-36-1847	5569-20A2S-T	20			50-36-1848	5569-20A2S-210-T	20		
50-36-1857	5569-22A2S-T	22			50-36-1858	5569-22A2S-210-T	22		
50-36-1867	5569-24A2S-T	24			50-36-1868	5569-24A2S-210-T	24		

50-36-1755	5569-02A2GS-T	2	30 μ" SELECT GOLD SEE NOTE 2 OPTION "GS"	94V-2	50-36-1756	5569-02A2GS-210-T	2	30 μ" SELECT GOLD SEE NOTE 2 OPTION "GS"	94V-0
50-36-1765	5569-04A2GS-T	4			50-36-1766	5569-04A2GS-210-T	4		
50-36-1775	5569-06A2GS-T	6			50-36-1776	5569-06A2GS-210-T	6		
50-36-1785	5569-08A2GS-T	8			50-36-1786	5569-08A2GS-210-T	8		
50-36-1795	5569-10A2GS-T	10			50-36-1796	5569-10A2GS-210-T	10		
50-36-1805	5569-12A2GS-T	12			50-36-1806	5569-12A2GS-210-T	12		
50-36-1815	5569-14A2GS-T	14			50-36-1816	5569-14A2GS-210-T	14		
50-36-1825	5569-16A2GS-T	16			50-36-1826	5569-16A2GS-210-T	16		
50-36-1835	5569-18A2GS-T	18			50-36-1836	5569-18A2GS-210-T	18		
50-36-1845	5569-20A2GS-T	20			50-36-1846	5569-20A2GS-210-T	20		
50-36-1855	5569-22A2GS-T	22			50-36-1856	5569-22A2GS-210-T	22		
50-36-1865	5569-24A2GS-T	24			50-36-1866	5569-24A2GS-210-T	24		

26-01-3177	5569-02AGS3-210-T	2	50 μ" SELECT GOLD SEE NOTE 2 OPTION "GS3"	94V-0	26-01-3101	5569-02A2GS-BL-T	2	30 μ" SELECT GOLD SEE NOTE 2 OPTION "GS"	BLACK 94V-2
26-01-3178	5569-04AGS3-210-T	4			NOT TOOLED	5569-04A2GS-BL-T	4		
		6			NOT TOOLED	5569-06A2GS-BL-T	6		
		8			NOT TOOLED	5569-08A2GS-BL-T	8		
26-01-3094	5569-10AGS3-210-T	10			NOT TOOLED	5569-10A2GS-BL-T	10		
		12			NOT TOOLED	5569-12A2GS-BL-T	12		
		14			NOT TOOLED	5569-14A2GS-BL-T	14		
		16			26-01-3108	5569-16A2GS-BL-T	16		
		18			NOT TOOLED	5569-18A2GS-BL-T	18		
		20			NOT TOOLED	5569-20A2GS-BL-T	20		
		22			NOT TOOLED	5569-22A2GS-BL-T	22		
		24			NOT TOOLED	5569-24A2GS-BL-T	24		

26-01-3114	5569-02A2GS2-T	2	15 μ" SELECT GOLD SEE NOTE 2 OPTION "GS2"	94V-2		2		
26-01-3115	5569-04A2GS2-T	4				4		
26-01-3116	5569-06A2GS2-T	6				6		
NOT TOOLED	5569-08A2GS2-T	8				8		
NOT TOOLED	5569-10A2GS2-T	10				10		
26-01-3119	5569-12A2GS2-T	12				12		
NOT TOOLED	5569-14A2GS2-T	14				14		
NOT TOOLED	5569-16A2GS2-T	16				16		
NOT TOOLED	5569-18A2GS2-T	18				18		
NOT TOOLED	5569-20A2GS2-T	20				20		
NOT TOOLED	5569-22A2GS2-T	22				22		
26-01-3126	5569-24A2GS2-T	24				24		

REVISION: L6	ECR/ECN INFORMATION: EC No: UCP2010-1417 DATE: 2010/11/30	TITLE: MINI-FIT JR.® RIGHT ANGLE HEADER ASSEMBLIES WITH MOUNTING PEGS	SHEET No. - 7 -
---------------------	--	--	------------------------

DOCUMENT NUMBER: SDA-5569-NA2*-*	Drawn By: JJAGUILAR	Checked By: JBELL	Approved By: FSMITH
---	----------------------------	--------------------------	----------------------------