

Applications

- Point-to-Point Radio



28-pin 5x5mm QFN package

Product Features

- RF Frequency Range: 36 – 45 GHz
- IF Frequency: DC – 3.5 GHz
- LO Frequency: 8.1 – 10.4 GHz
- LO Input Power: +2 to +8 dBm
- Conversion Gain: 11 dB
- Package Dimensions: 5.0 x 5.0 mm

General Description

The TriQuint TGC4546-SM is a Ka-Band Upconverter with integrated LO buffer amplifier and quadrupler, housed in a 28 lead 5x5 mm QFN package. The TGC4546-SM operates from an RF of 36 to 45 GHz and LO from 8.1 to 10.4 GHz with IF inputs from DC to 3.5 GHz and is designed using TriQuint's pHEMT production process.

The TGC4546-SM typically provides 27 dBm of output TOI, and 11 dB of conversion gain.

Lead-free and RoHS compliant.

Functional Block Diagram

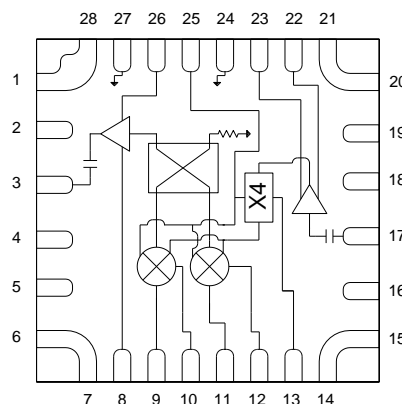

Pin Configuration

Pin No.	Label
1, 2, 4, 5, 6, 7, 14, 15, 16 18, 19, 20, 21, 28	NC
3	RF OUT
8	VGRF
9	IF2+
10	IF2-
11	IF1-
12	IF1+
13	VGMU
17	LO IN
22	VGLO
23	VDLO
24, 27	GND
25	VGX
26	VDRF

Ordering Information

Part No.	ECCN	Description
TGC4546-SM	EAR99	36 – 45 GHz Upconverter with x4

Standard T/R size = 200 pieces on a 7" reel

Absolute Maximum Ratings

Parameter	Rating
VDRF	6 V
VGRF	-3 to +1.5 V
IDRF	380 mA
VDLO	6 V
VGLO	-3 to +1.5 V
IDLO	320 mA
VGX	-3 to 0 V
LO Input Power	+15 dBm
IF Input Power, 50Ω, T = 25°C	+15 dBm
Channel Temperature, T _{ch}	200 °C
Storage Temperature	-65 to 125 °C

Operation of this device outside the parameter ranges given above may cause permanent damage.

Recommended Operating Conditions

Parameter	Min	Typ	Max	Units
Operating Temp. Range	-40	25	+85	°C
VDRF		5		V
IDRF		230		mA
VGRF		-0.68		V
VDLO		4		V
IDLO		250		mA
VGLO		-0.62		V
VGX		-1.1		V
VGMU		-1		V
LO Input Power	+2		+8	dBm
IF Input Power		-10		dBm

Electrical specifications are measured at specified test conditions. Specifications are not guaranteed over all recommended operating conditions.

Electrical Specifications

Test conditions unless otherwise noted: VDRF= +5 V, IDRf= 230 mA, VGRF = -0.68 V, VDLO= +4 V, IDLO= 250 mA, VGLO= -0.62 V, VGX= -1.1 V, VGMU = -1 V, IF = 2.5 GHz at -10 dBm, LO nulling applied, Temperature = 25°C

Parameter	Min	Typ	Max	Units
RF Frequency Range	36		45	GHz
LO Frequency Range	8.1		10.4	GHz
IF Frequency Range	DC		3.5	GHz
Conversion Gain		11		dB
2LO-to-RF Leakage		-45		dBm
4LO-to-RF Leakage		-35		dBm
OIP3		27		dBm
Output P1dB		18		dBm
Image Rejection		9		dB
RF Return Loss		10		dB
IF Return Loss		10		dB
LO Return Loss		8		dB

Specifications

Thermal and Reliability Information

Parameter	Conditions	Rating
Thermal Resistance, θ_{JC} , measured to back of package	Tbase = 85 °C	$\theta_{JC} = 20.8 \text{ }^{\circ}\text{C/W}$
Channel Temperature (Tch), and Median Lifetime (Tm)	Tbase = 85 °C Pdiss = 5V*245mA + 4V*290mA = 2.4 W	Tch = 135 °C Tm = 5.8E+6 Hours

Median Lifetime (Tm) vs. Channel Temperature (Tch)

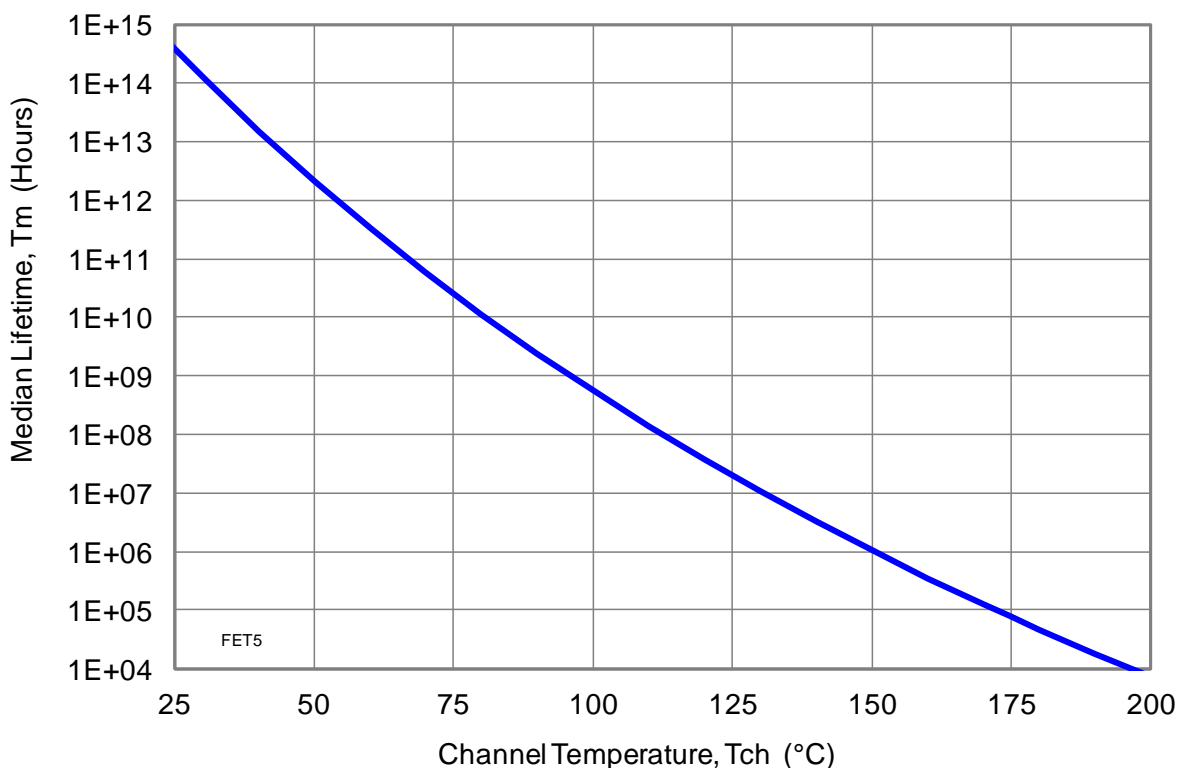

Typical Performance

Test conditions unless otherwise noted: VDRF= +5 V, IDRf= 230 mA, VGRF = -0.68 V, VDLO= +4 V, IDLO= 250 mA, VGLO= -0.62 V, VGX= -1.1 V, VGMU = -1 V, IF = 2.5 GHz at -10 dBm, LO nulling applied

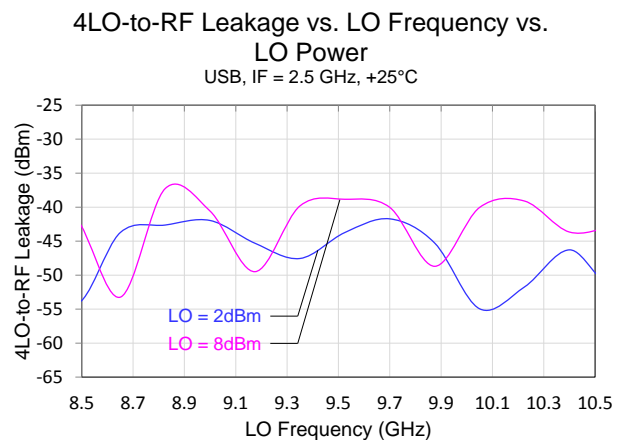
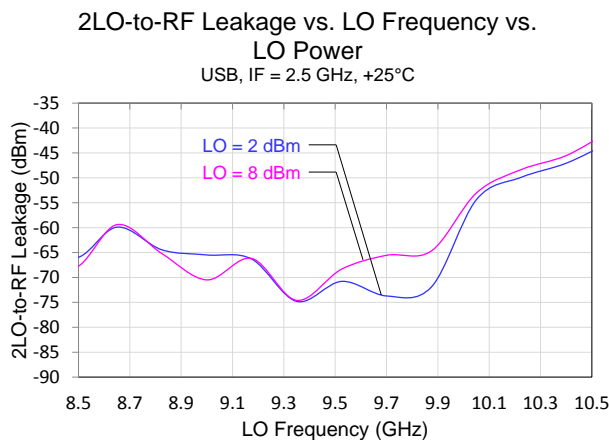
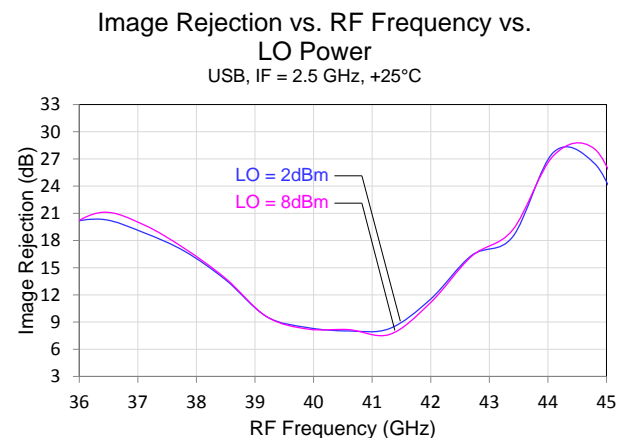
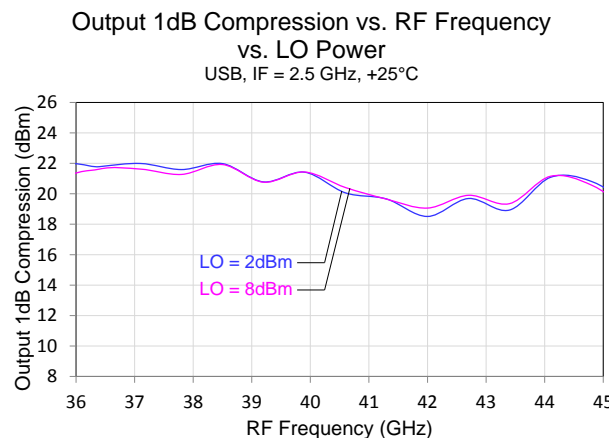
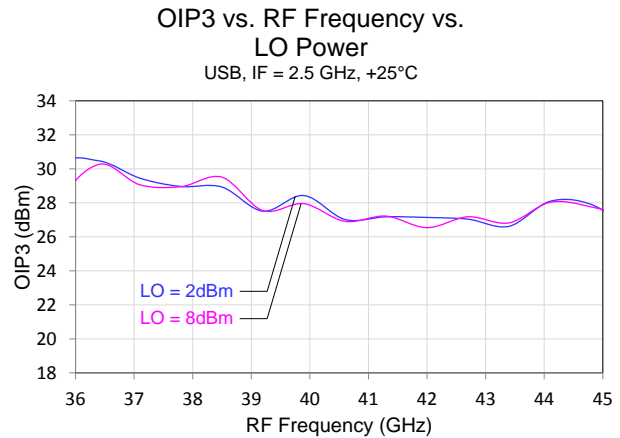
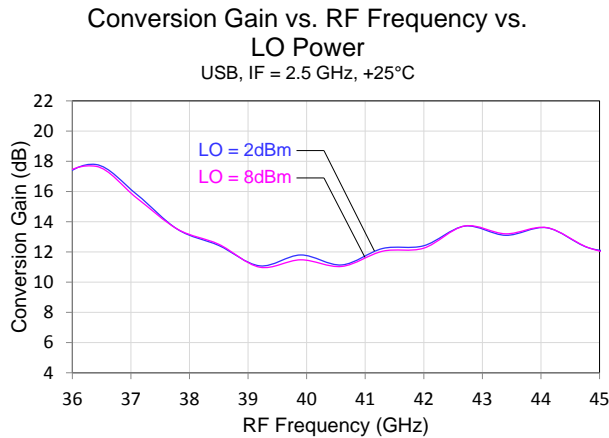

Typical Performance

Test conditions unless otherwise noted: VDRF= +5 V, IDRF= 230 mA, VGRF = -0.68 V, VDLO= +4 V, IDLO= 250 mA, VGLO= -0.62 V, VGX= -1.1 V, VGMU = -1 V, IF = 2.5 GHz at -10 dBm, LO nulling applied

RF Port Return Loss vs. Frequency

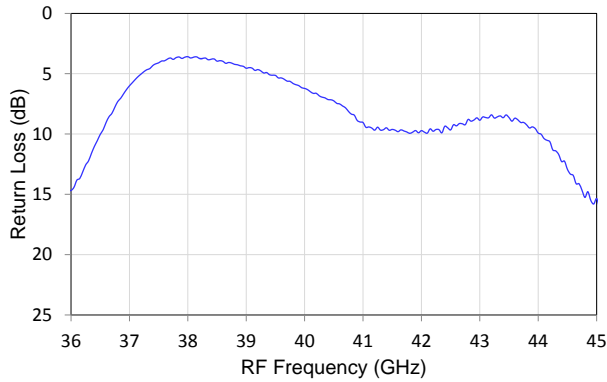

IF Port Return Loss vs. Frequency

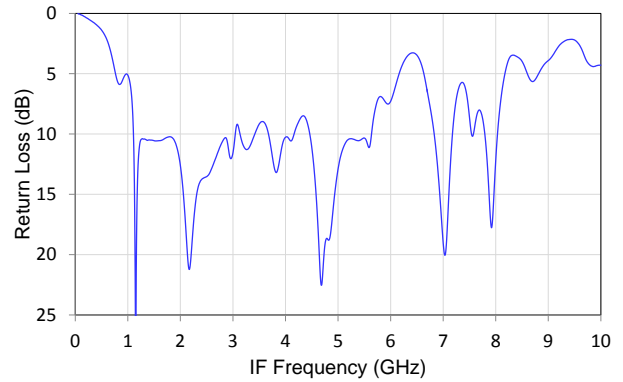

LO Port Return Loss vs. Frequency vs. LO Power

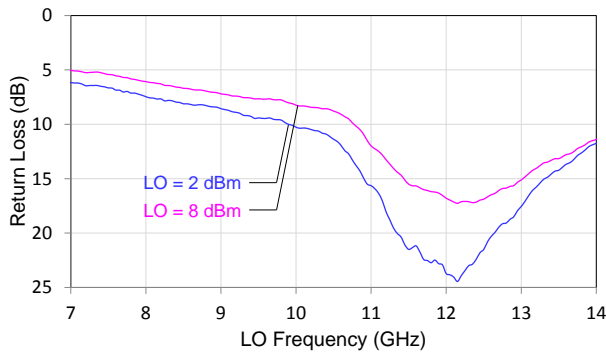

LO Nulling Voltage vs. LO Frequency vs. LO Power

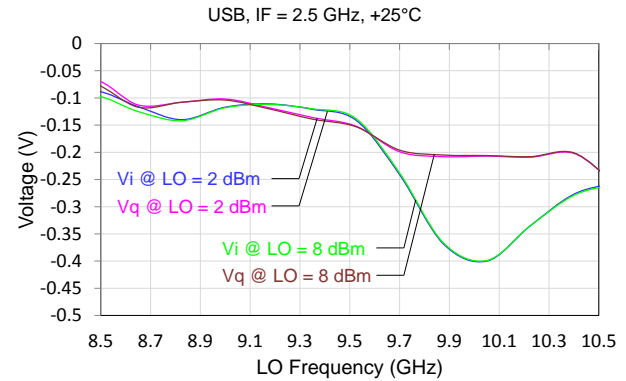

Current for LO Nulling Voltage vs. LO Frequency vs. LO Power

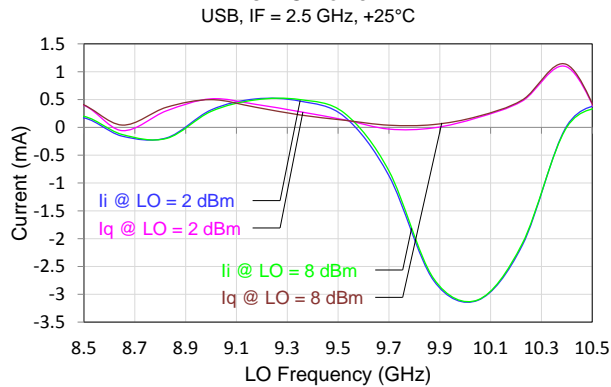

Typical Performance

Test conditions unless otherwise noted: VDRF= +5 V, IDRF= 230 mA, VGRF = -0.68 V, VDLO= +4 V, IDLO= 250 mA, VGLO= -0.62 V, VGX= -1.1 V, VGMU = -1 V, IF = 2.5 GHz at -10 dBm, LO nulling applied

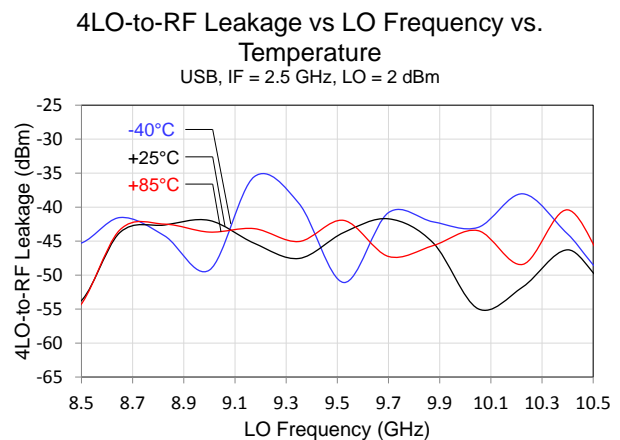
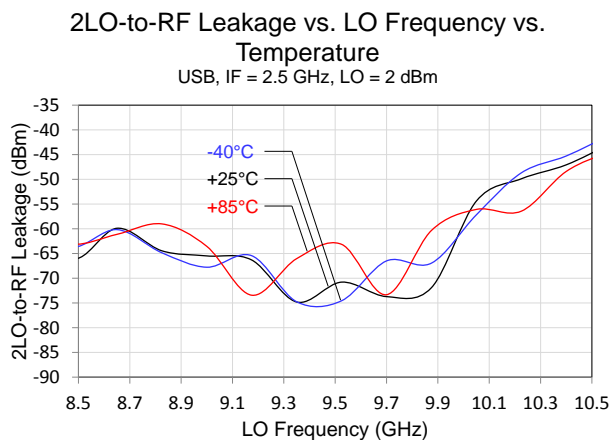
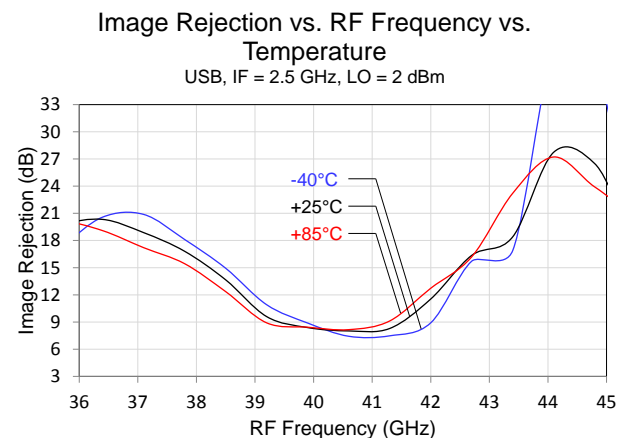
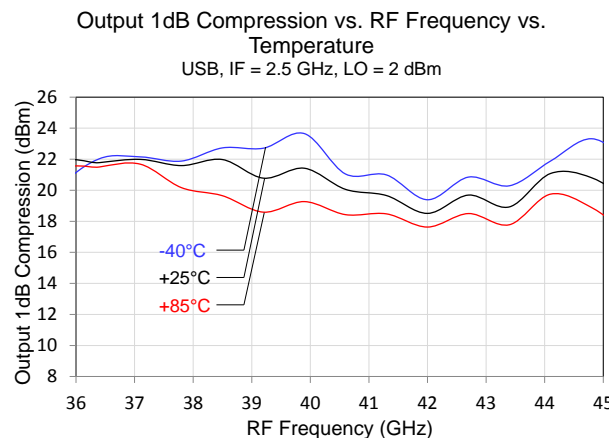
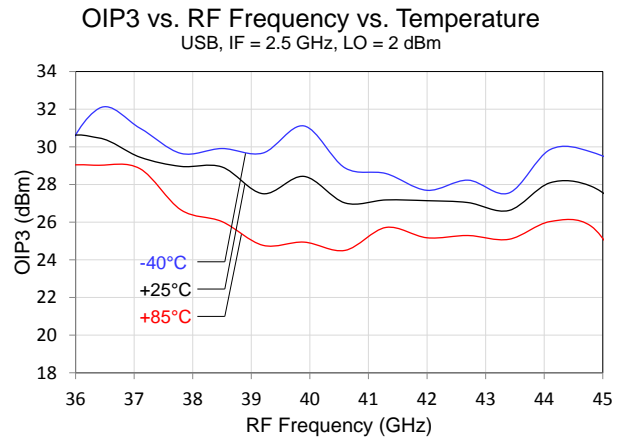
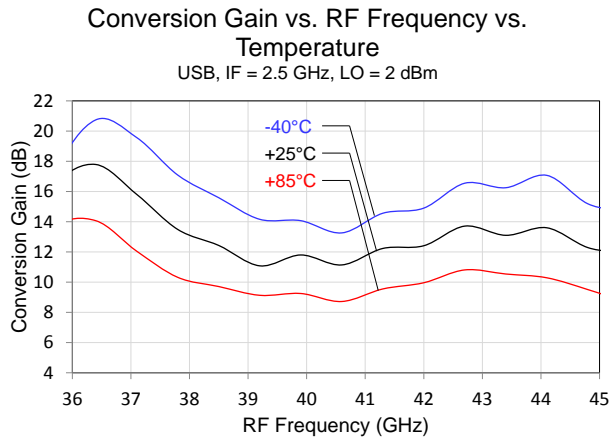

Typical Performance

Test conditions unless otherwise noted: $V_{DRF} = +5\text{ V}$, $I_{DRF} = 230\text{ mA}$, $V_{GRF} = -0.68\text{ V}$, $V_{DLO} = +4\text{ V}$, $I_{DLO} = 250\text{ mA}$, $V_{GLO} = -0.62\text{ V}$, $V_{GX} = -1.1\text{ V}$, $V_{GMU} = -1\text{ V}$, $f_{IF} = 2.5\text{ GHz}$ at -10 dBm , LO nulling applied

Spur Tables

Spur tables are $M \times f_{LO} + N \times f_{RF}$ mixer spurious products for -10 dBm IF input power. All values in dBc below the RF output power level.

M x N Spurious Outputs for USB, $f_{IF} = 2.5\text{ GHz}$

		M x f_{LO}					
		0	1	2	3	4	5
N x f_{RF}	-2		77	73	71	44	42
	-1		77	65	36	8	13
	0		44	32	17	38	-7
	1	48	67	57	15	0	-5
	2	79	62	69	44	27	32

Pin Configuration and Description

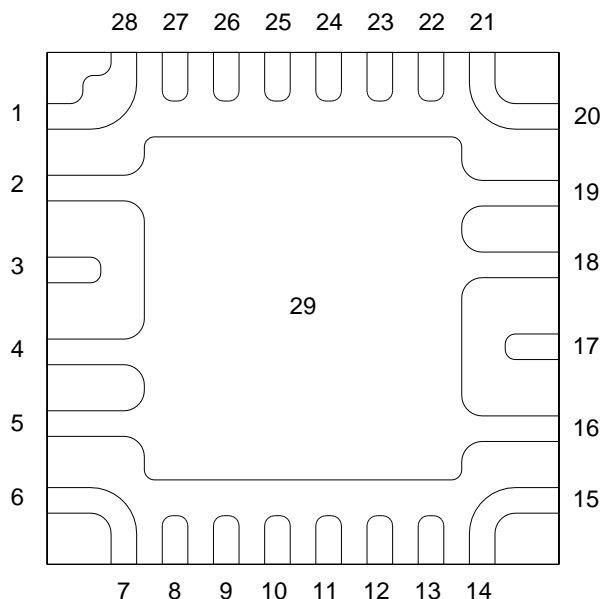

Pin No.	Label	Description
1, 2, 4, 5, 6, 7, 14, 15, 16, 18, 19, 20, 21, 28	NC	No internal connection; must be grounded on PCB.
3	RF OUT	RF Output, matched to 50 ohms, AC Coupled.
8	VGRF	RF Gate Voltage. Bias network is required; see Application Circuit on page 10 as an example
9	IF2+	IF differential input
10	IF2-	IF differential input
11	IF1-	IF differential input
12	IF1+	IF differential input
13	VGMU	Multiplier Voltage.
17	LO IN	LO Input, matched to 50 ohms, AC coupled.
22	VGLO	LO Gate Voltage. Bias network is required; see Application Circuit on page 10 as an example.
23	VDLO	LO Drain Voltage. Bias network is required; see Application Circuit on page 10 as an example.
24, 27	GND	Internal Grounding; must be grounded on PCB.
25	VGX	Mixer Voltage. Bias network is required; see Application Circuit on page 10 as an example.
26	VDRF	RF Drain Voltage. Bias network is required; see Application Circuit on page 10 as an example.
29	GND	Backside Paddle. Multiple vias should be employed to minimize inductance and thermal resistance; see Mounting Configuration on page 13 for suggested footprint.

Application Circuit

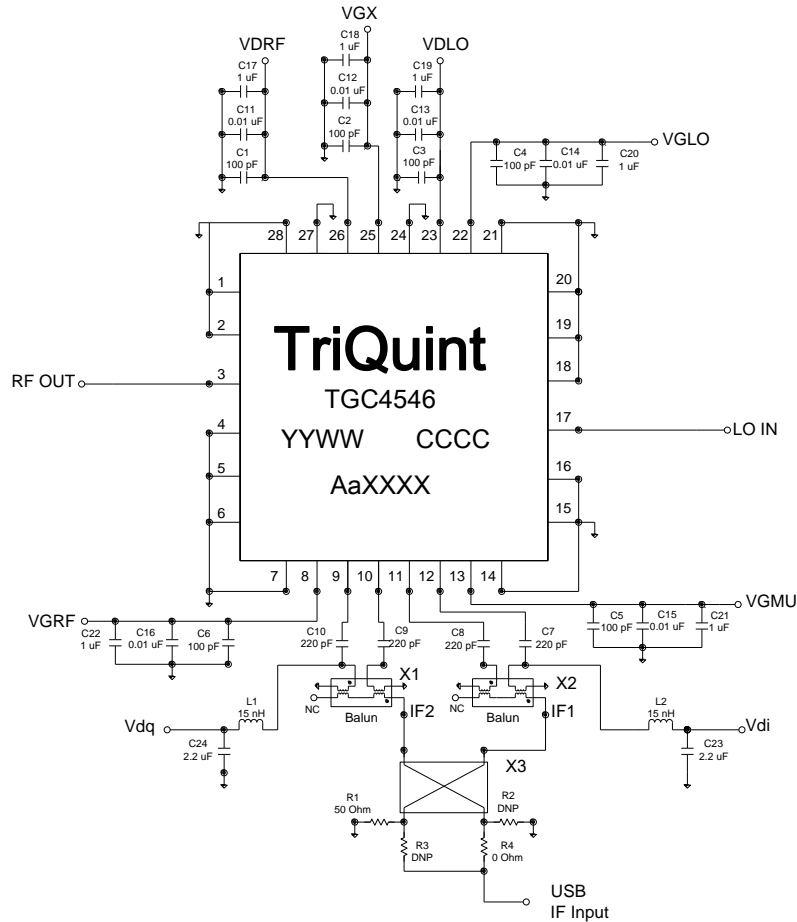

Bias-up Procedure	Bias-down Procedure
Set VGX to -1.1 V	Turn off RF signal
Set VGMU to -1V	Reduce VDLO to 0 V
Set VGLO to -2 V	Reduce VDRF to 0 V
Set VDLO to +5.0 V	Reduce VGLO to 0 V
Increase VGLO to get IDLO = 250 mA	Reduce VGRF to 0 V
Set VGRF to -2 V	Reduce VGMU to 0 V
Set VDRF to +5.0 V	Reduce VGX to 0 V
Increase VGRF to get IDRF = 230 mA	
Apply RF signal	

Application Circuit

PC Board Layout

Board material is RO4003 0.008" thickness with 1/2 oz copper cladding.

For further technical information, refer to the [TGC4546-SM](#) Product Information page.

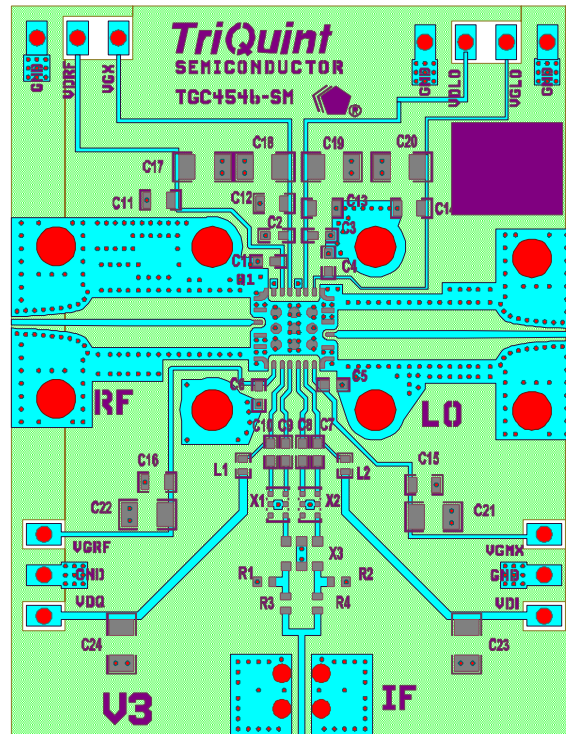

Bill of Material

Ref Des	Value	Description	Manufacturer	Part Number
C1 – C6	100 pF	Cap, 0402, 50V, 5%, NPO	various	
C7 – C10	220 pF	Cap, 0402, 50V, 5%, NPO	various	
C11 – C16	0.01 µF	Cap, 0603, 25V, 5%, COG	various	
C17 – C22	1 µF	Cap, 0805, 25V, 5%, X5R	various	
C23, C24	2.2 µF	Cap, 0805, 25V, 5%, X5R	various	
L1, L2	15 nH	Inductor, 0402, 460mA, SMD	various	
R1	0 Ohm	Res, 0402, 0.01W, SMD	various	
R4	50 Ohm	Res, 0402, 0.05W, 0.1%, SMD	various	
R2, R3		DNP		
Q1		Ku-Band Upconverter	TriQuint	TGC4546-SM
X1, X2		Balun	Mini-Circuits	NCS1- 292
X3		Power Splitter	Mini-Circuits	QCN-34+

Mechanical Information

Package Marking and Dimensions

All dimensions are in millimeters.

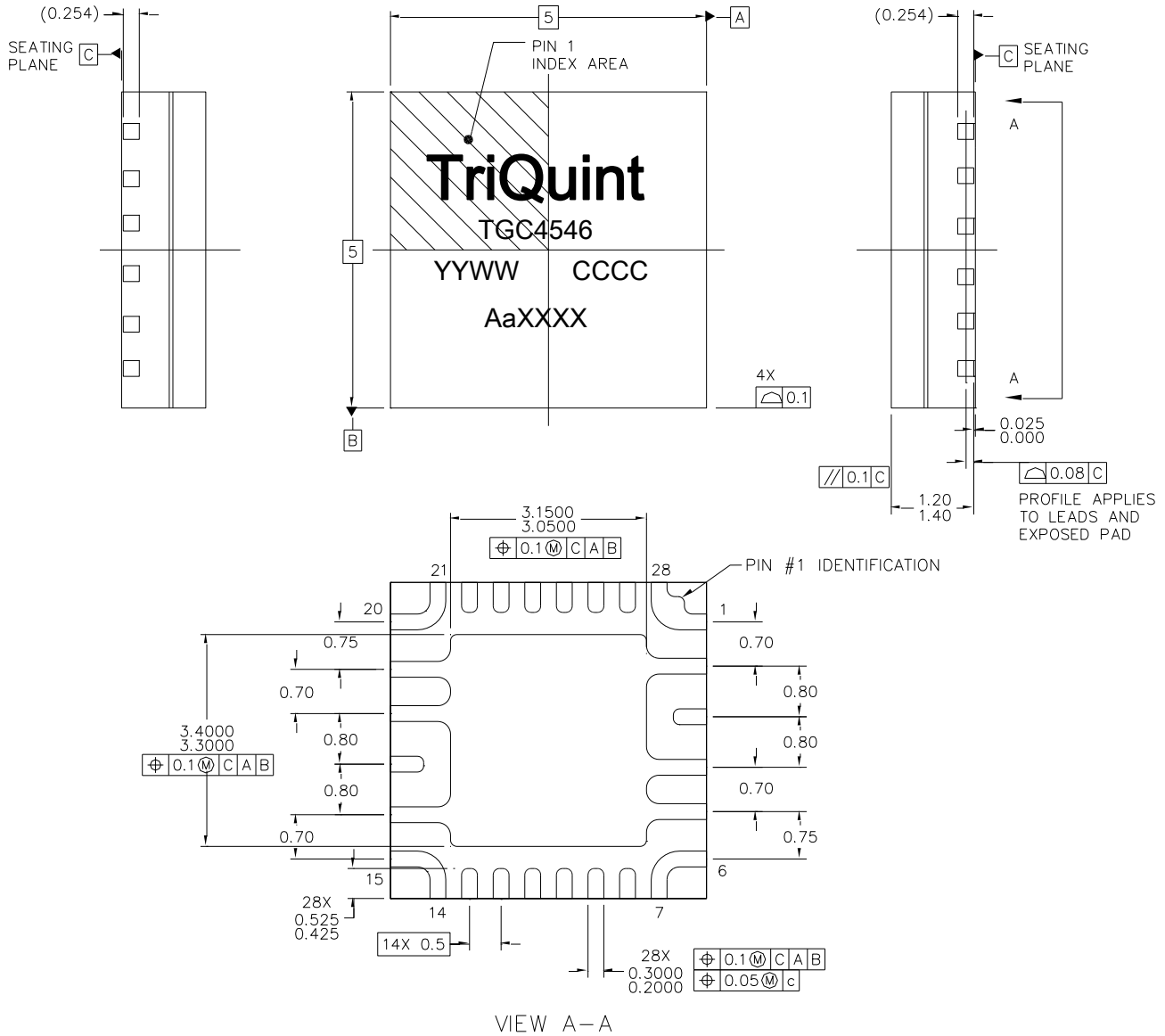

The TGC4546-SM will be marked with the “YYWW” designator and a lot code marked below the part designator. The “YY” represents the last two digits of the year the part was manufactured, the “WW” is the work week, the “CCCC” is the country code, the “Aa” is the vendor, and the “XXXX” is the last 4 digit of lot number.

This package is lead-free/RoHS-compliant with a copper alloy base (CDA194), and the plating material on the leads is NiPdAu. It is compatible with a lead-free (maximum 260 °C reflow temperature) soldering process.

Mechanical Information

PCB Mounting Pattern

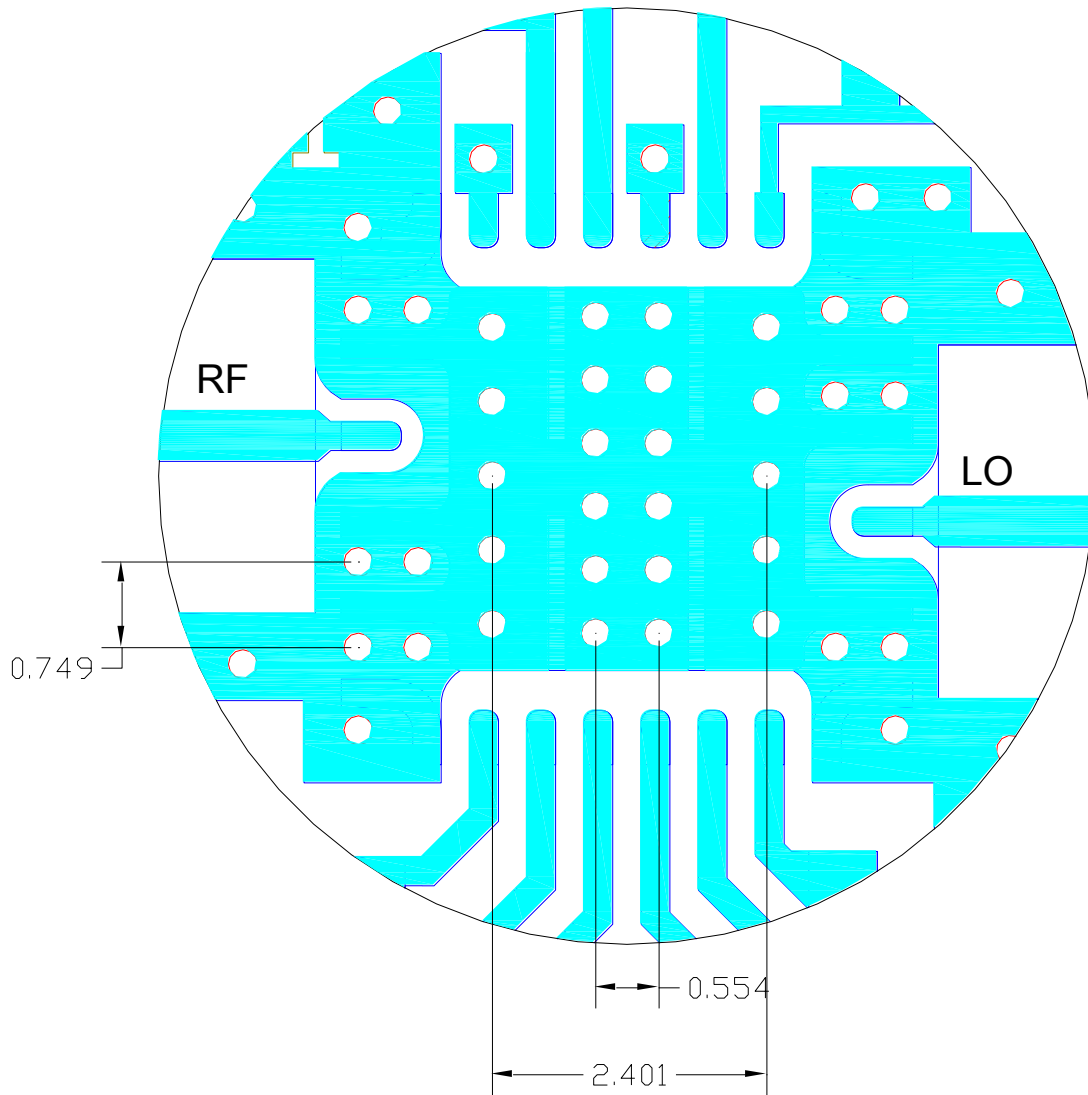

Notes:

1. The pad pattern shown has been developed and tested for optimized assembly at TriQuint Semiconductor. The PCB land pattern has been developed to accommodate lead and package tolerances. Since surface mount processes vary from company to company, careful process development is recommended.
2. Ground vias are critical for the proper performance of this device. Vias should use a .35mm (#80 / .0135") diameter drill and have a final plated thru diameter of .25 mm (.010").

Tape and Reel Information

Standard T/R size = 200 pieces on a 7" reel.

Material		Cavity (mm)				Distance Between Centerline (mm)		Carrier Tape (mm)	Cover Carrier (mm)
Vendor	Vendor P/N	Length (A0)	Width (B0)	Depth (K0)	Pitch (P1)	Length direction (P2)	Width Direction (F)	Width (W)	Width (W)
Tek-Pak	QFN0500X0 500F-L500	5.3	5.3	1.65	8.0	2.00	5.50	12.0	9.20

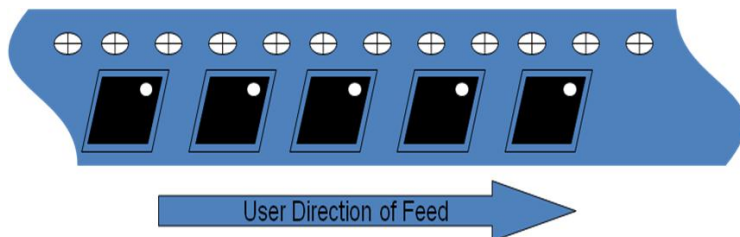
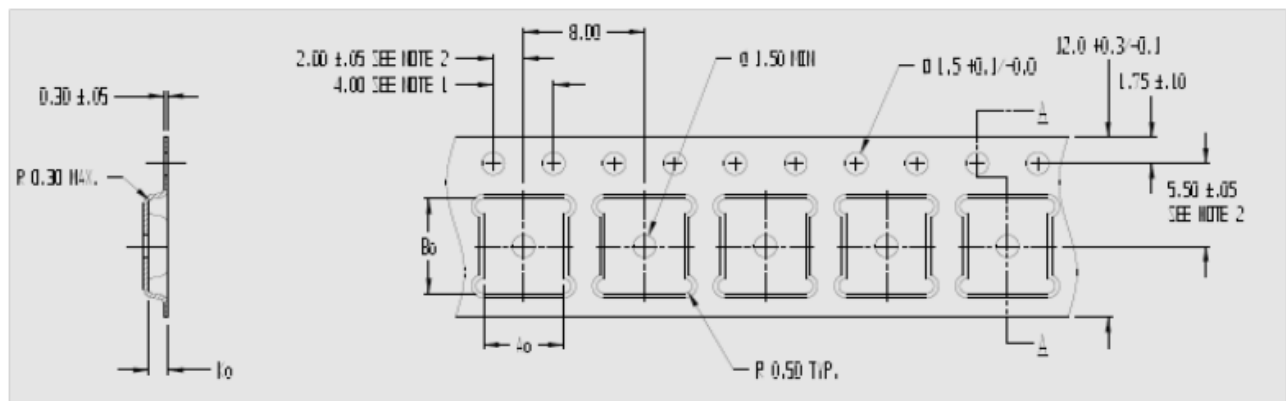

Product Compliance Information

ESD Sensitivity Ratings



Caution! ESD-Sensitive Device

ESD Rating: Class 1A
 Value: Pass ≥ 250 V min.
 Test: Human Body Model (HBM)
 Standard: JEDEC Standard JESD22-A114

MSL Rating

MSL Rating: Level 3
 Test: 260°C convection reflow
 Standard: JEDEC Standard IPC/JEDEC J-STD-020

Solderability

Compatible with lead-free (260 °C maximum reflow temperature)soldering processes.

Package lead plating: NiAu.

The use of no-clean solder to avoid washing after soldering is recommended.

This package is not compatible with solder containing lead.

RoHs Compliance

This part is compliant with EU 2002/95/EC RoHS directive (Restrictions on the Use of Certain Hazardous Substances in Electrical and Electronic Equipment).

This product also has the following attributes:

- Lead Free
- Halogen Free (Chlorine, Bromine)
- Antimony Free
- TBBP-A ($C_{15}H_{12}Br_4O_2$) Free
- PFOS Free
- SVHC Free

Recommended Solder Temperature Profile

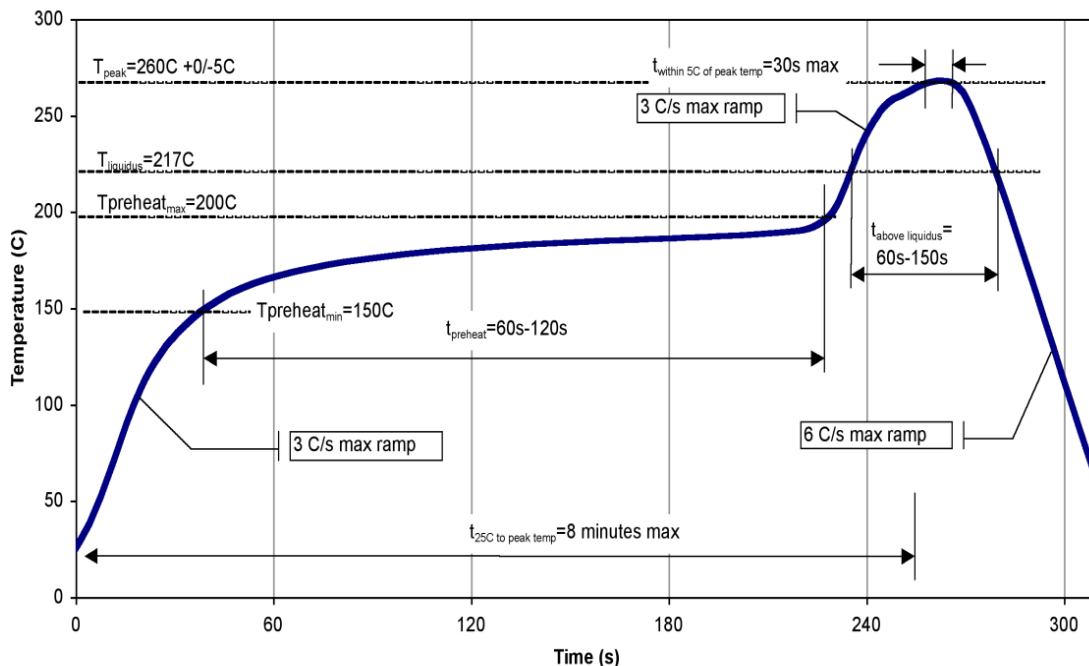

Contact Information

For the latest specifications, additional product information, worldwide sales and distribution locations, and information about TriQuint:

Web: www.triquint.com
Email: info-sales@tqs.com

Tel: +1.972.994.8465
Fax: +1.972.994.8504

For technical questions and application information: **Email:** info-networks@tqs.com

Important Notice

The information contained herein is believed to be reliable. TriQuint makes no warranties regarding the information contained herein. TriQuint assumes no responsibility or liability whatsoever for any of the information contained herein. TriQuint assumes no responsibility or liability whatsoever for the use of the information contained herein. The information contained herein is provided "AS IS, WHERE IS" and with all faults, and the entire risk associated with such information is entirely with the user. All information contained herein is subject to change without notice. Customers should obtain and verify the latest relevant information before placing orders for TriQuint products. The information contained herein or any use of such information does not grant, explicitly or implicitly, to any party any patent rights, licenses, or any other intellectual property rights, whether with regard to such information itself or anything described by such information.

TriQuint products are not warranted or authorized for use as critical components in medical, life-saving, or life-sustaining applications, or other applications where a failure would reasonably be expected to cause severe personal injury or death.