

Model:KMB229-201

characteristics:

It uses EI high quality magnetic core,overcoming shortcoming of toroidal core.The first pulse current amplitude is greater than 1A. applicable for SCR below 500A.

Technical indicators:

Installation method: PCB

Flame resistance: UL94-V0

Operating temperature: $-20^{\circ}\text{C} \sim +50^{\circ}\text{C}$

Storage temperature: $-40^{\circ}\text{C} \sim +85^{\circ}\text{C}$

Frequency range: 1KHz~10KHz

Dielectric strength: 5KV 50Hz 1min



Electrical parameters:

Vout microsecond integral	1600	μVs
Pulse width (D=1:2)	100	μs
Ratio	2 : 1	
Input amplitude	15	V
Output amplitude	≥ 5	V
Load impedance	7	Ω
Leading edge time	≤ 5	μs
Main circuit operating voltage	660	V
Weight		g

Connection diagram:

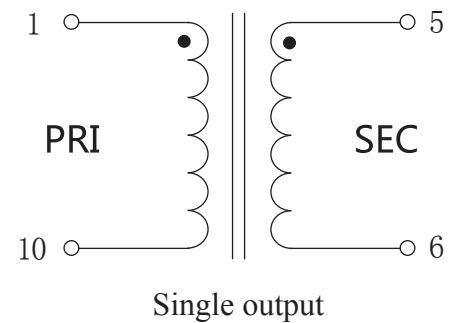

Dimensions (in mm) :

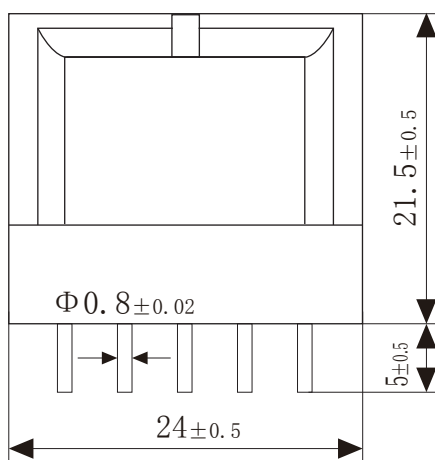

Front View

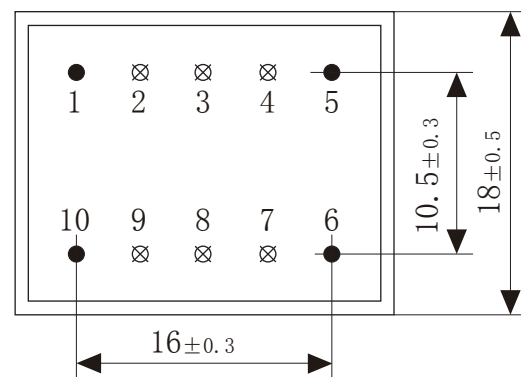

Bottom View