



### Product Features

- 250-3000 MHz Bandwidth
- 44 dBm Output IP3 in a Balanced Configuration
- 47 dBm Output IP3 in a Push-Pull Configuration
- 3.7 dB Noise Figure
- 12 dB Gain
- 27 dBm P1dB
- Surface Mount
- Thermally Enhanced SOIC-8 pkg
- Single +5 Volt Supply

### Product Description

The AH11 is a high power linear amplifier for use in digital communications systems. It combines low noise figure and high intercept point into a low cost SMT solution. This device extends the linear efficiency advantages of WJ's AH1 to higher power levels. The device packaging allows for both balanced and push-pull operation. A mature and reliable GaAs MESFET technology is employed to maximize linearity at low power dissipation. The package is a thermally enhanced SOIC-8 and all devices are 100% RF tested.

### Functional Diagram

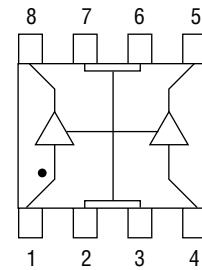

Function	Pin No.
Input 1	1
Ground	2,3,6,7
Input 2	4
Output/Bias2	5
Output/Bias1	8

### Specifications

Parameter	Minimum	Typical	Maximum	Condition
Supply Voltage (V)		5		
Frequency Range (MHz)		600-2100		Frequency Range Limited by Ext Couplers
S21-Gain (dB)	11.0	12.2		900 MHz
S21-Gain (dB)	10.0	11.2		1900MHz
S11/S22 (dB) I/O Return Loss		-15		
Output IP3 (dBm)	44	46		900 MHz
Output IP3 (dBm)	42	44		1900 MHz (In a Balanced Configuration)
Noise Figure (dB)		4.2		
Output P1dB (dBm)		24		
Operating Current Range (mA)	240	300	360	
Frequency Range (MHz)		1700-2000		Frequency Range Limited by Ext Baluns
S21-Gain (dB)		12.0		
S11/S22 (dB) I/O Return Loss		-12		
Output IP3 (dBm)		47		(In a 1900 MHz Push-Pull Configuration)
Noise Figure (dB)		3.7		
Output P1dB (dBm)		27		
Operating Current Range (mA)	480	600	720	

Test conditions unless otherwise noted. T = 25°C, Vdd = 5.0 V, 50 Ω system.

1. Typical specifications reflect AH11 measured with external matching circuits.

2. OIP3 measured with 2 tones at an output power of 8 dBm/tone balanced, 11 dBm/tone push-pull, separated by 10 MHz.

The suppression on the largest IM3 product is used to calculate OIP3 using a 2:1 slope rule.

3. Balun loss affects noise figure.

### Absolute Maximum Ratings

Parameter	Rating
Operating Case	-40 to +85°C
Storage Temperature	-40 to +125°C
Junction Temperature	+155°C
Thermal Resistance (θ <sub>JC</sub> )	28°C/W
Supply Voltage	+6.0 V
Input RF Power (continuous)	+13 dBm

Operation of this device above any of these parameters may cause permanent damage.

### Ordering Information

Part No.	Description
AH11	High Dynamic Range Amplifier (Available in tape and reel)
AH11BAL-PCB	Fully Assembled Circuit Balanced Configuration 600-2100 MHz
AH11PP900-PCB	Fully Assembled Circuit Push-Pull Configuration 900 MHz
AH11PP1900-PCB	Fully Assembled Circuit Push-Pull Configuration 1900 MHz

# AH11

## Balanced Circuit: 600-2100 MHz

### Typical Performance (50 Ohm System)

Frequency	600 MHz	900 MHz	1900 MHz	2100 MHz
Magnitude S21	10.7 dB	12.2 dB	11.2 dB	10.6 dB
Magnitude S11	-10.0 dB	-10.0 dB	-13.5 dB	-10.0 dB
Magnitude S22	-12.7 dB	-18.2 dB	-10.0 dB	-10.0 dB
NF	7.62 dB	4.13 dB	4.16 dB	5.55 dB
OIP2	63 dBm	65 dBm	65 dBm	63 dBm
OIP3	42 dBm	46 dBm	44 dBm	45 dBm
Bias	Vds = 5.0 V, Id = 300 mA			

### Schematic

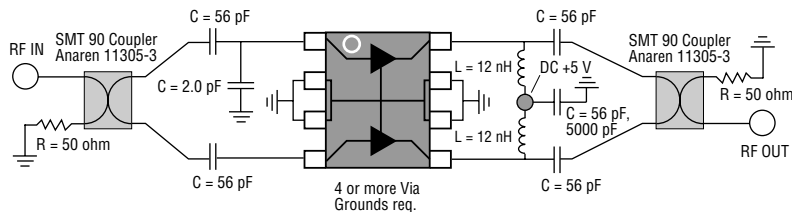

### FR4 Board Layout (T = 14 Mils to ground plane)

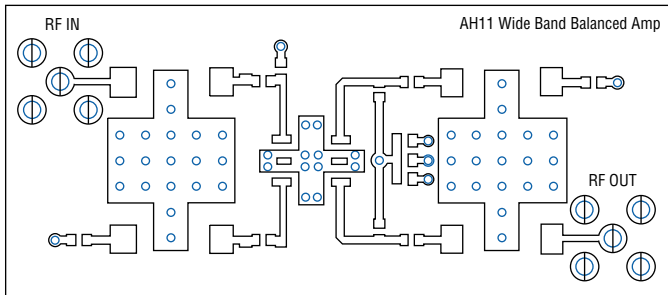

### Parts List

QTY	Description	Size	MFR	Part No.
1	Hi pwr Linear Amp	SOIC8	WJ	AH11
2	90 Coupler Wideband		Anaren	11305-3
5	56 pF Capacitor	0603	Kemet	
1	5000 pF Capacitor	0603	Kemet	
1	.01uF Capacitor	0805	Kemet	
2	12 nH Inductor	0603	Toko	
1	2.0 pF Capacitor	0603	Kemet	
4	100 ohm Resistor	0603		

## Performance Charts

### S-Parameters

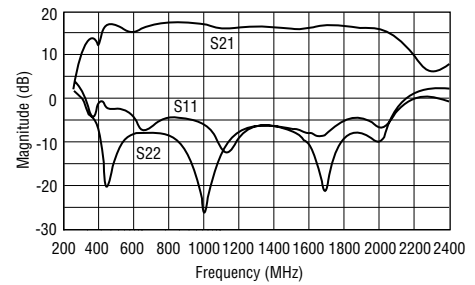

### NF vs. Frequency

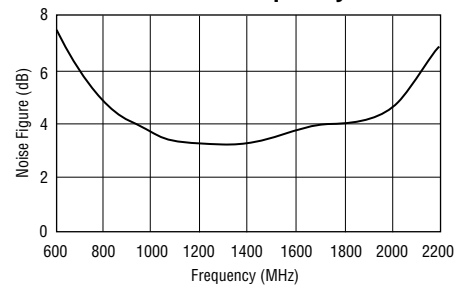

### OIP3 vs. Frequency

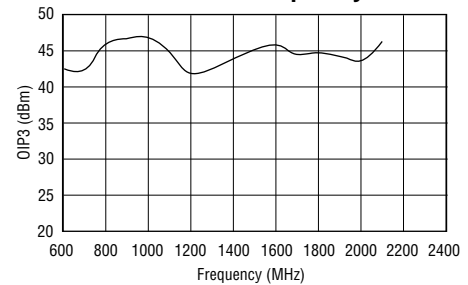

### MTTF vs. Temperature

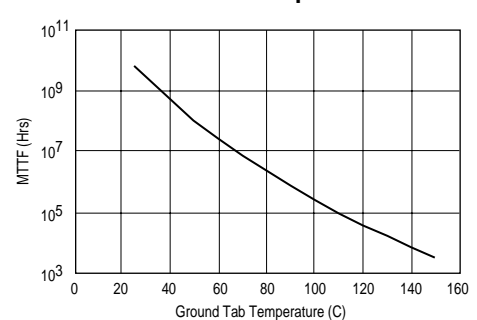

# Dual Push-Pull Circuit: 900 MHz

## Typical Performance (50 Ohm System)

Frequency	700 MHz	800 MHz	900 MHz	1000 MHz
Magnitude S21	13.8 dB	13.8 dB	13.4 dB	12.8 dB
Magnitude S11	-30.0 dB	-27.0 dB	-18.6 dB	-12.2 dB
Magnitude S22	-11.5 dB	-13.0 dB	-12.0 dB	-12.5 dB
NF	3.4 dB	3.1 dB	3.4 dB	3.4 dB
OIP3	48 dBm	48 dBm	48 dBm	48 dBm
Bias	V <sub>ds</sub> = 5.0 V, I <sub>d</sub> = 600 mA			

## Schematic

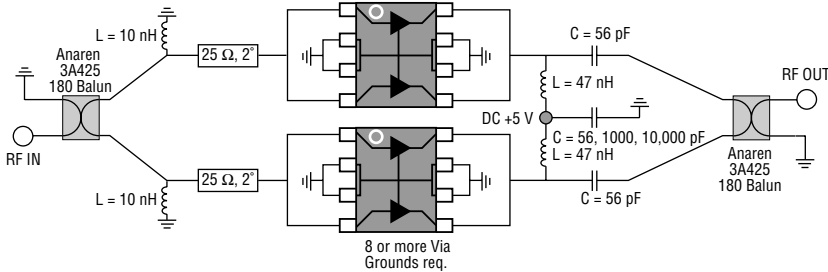

## FR4 Board Layout (T = 14 Mils to ground plane)

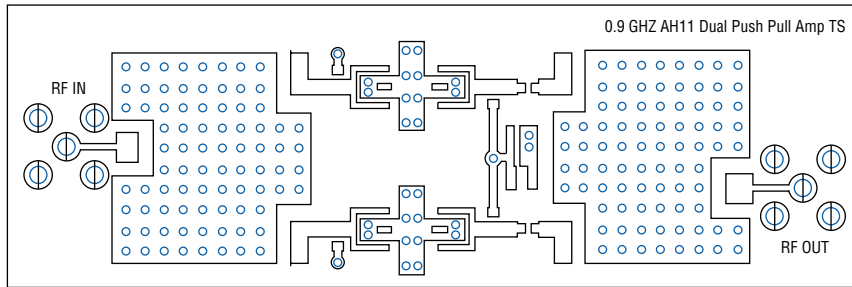

## Parts List

QTY	Description	Size	MFR	Part No.
2	Hi pwr Linear Amp	SOIC8	WJ	AH11
2	180 Balun 0.9 GHz		Anaren	3A425
5	56 pF Capacitor	0603	Kemet	
1	5000 pF Capacitor	0603	Kemet	
1	.01 uF Capacitor	0805	Kemet	
2	47 nH Inductor	0805	Coilcraft	0805CS-470XMBC
2	10 nH Inductor	0603	Toko	LL1608-F10NK

# Performance Charts

## S-Parameters

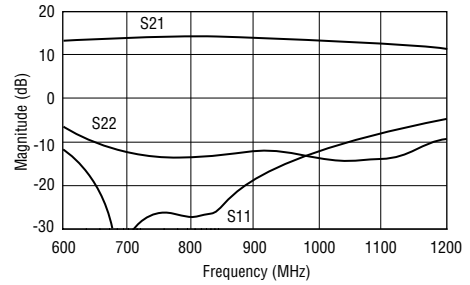

## OIP3 vs. Output Power

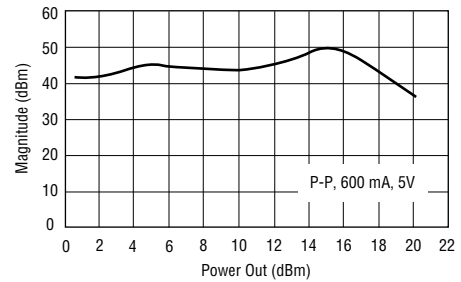

## OIP3 vs. Frequency

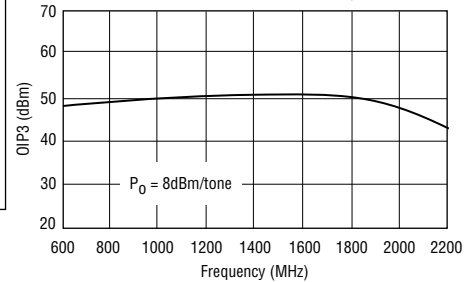

## MTTF vs. Temperature

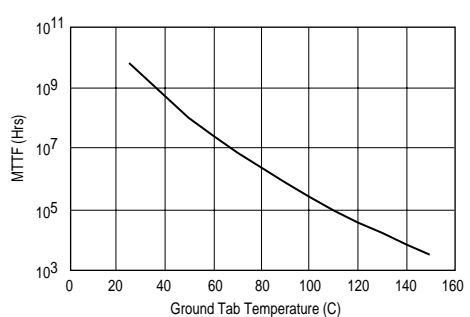

## Dual Push-Pull Circuit: 1900 MHz

### Typical Performance (50 Ohm System)

Frequency	1700 MHz	1800 MHz	1900 MHz	2000 MHz
Magnitude S21	11.8 dB	11.9 dB	11.9 dB	11.6 dB
Magnitude S11	-10.0 dB	-14.0 dB	-19.0 dB	-10.0 dB
Magnitude S22	-8.3 dB	-10.0 dB	-10.0 dB	-14.0 dB
NF	3.8 dB	3.6 dB	3.7 dB	3.6 dB
OIP3	47 dBm	47 dBm	48 dBm	48 dBm
Bias	Vds = 5.0 V, Id = 600 mA			

### Schematic

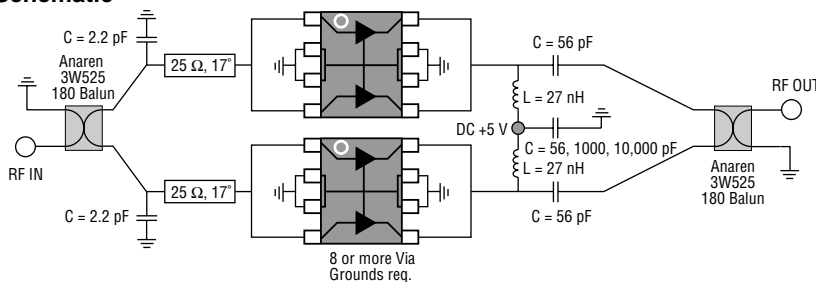

### FR4 Board Layout (T = 14 Mils to ground plane)

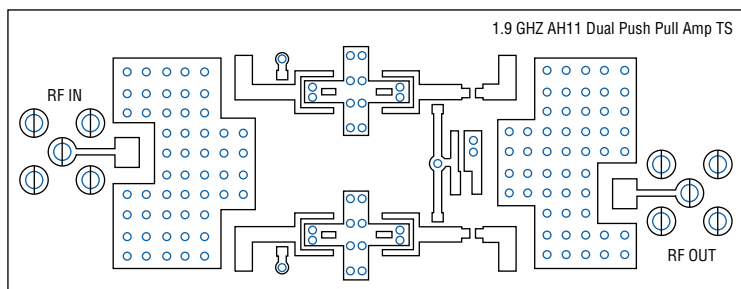

### Parts List

QTY	Description	Size	MFR	Part No.
2	Hi pwr Linear Amp	SOIC8	WJ	AH11
2	180 Balun 1.9 GHz		Anaren	3W525
5	56 pF Capacitor	0603	Kemet	
1	5000 pF Capacitor	0603	Kemet	
1	.01 uF Capacitor	0805	Kemet	
2	27 nH Inductor	0805	Coilcraft	0805CS-270XMBC
2	2.2 pF Capacitor	0603	Kemet	

## Performance Charts

### S-Parameters

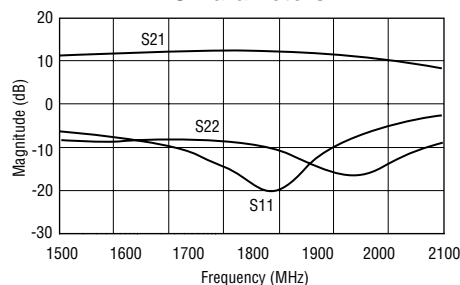

### OIP3 vs. Output Power

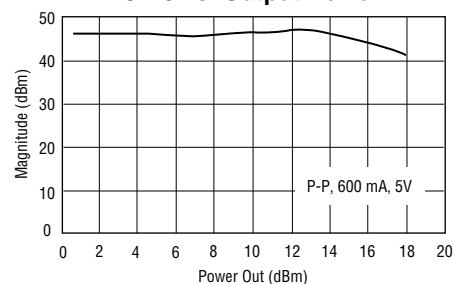

### MTTF vs. Temperature

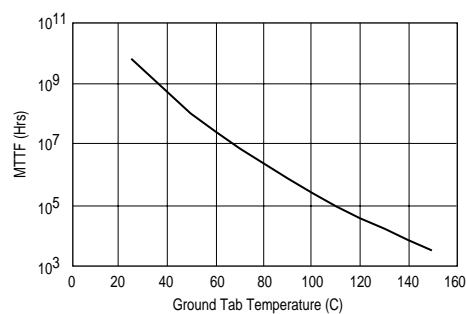

## Outline Drawing

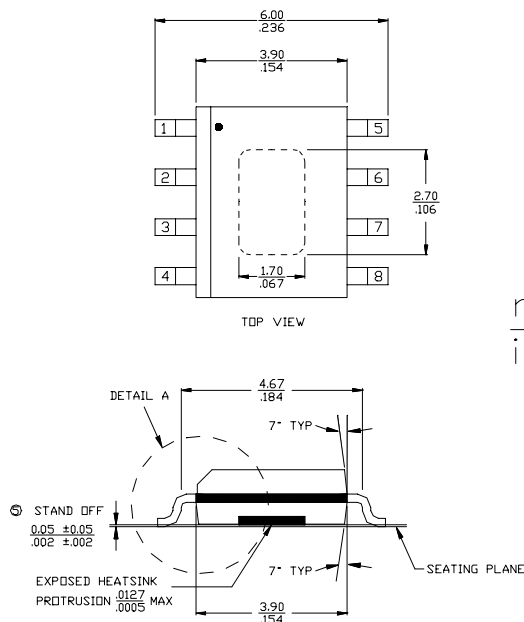

mm  
inch

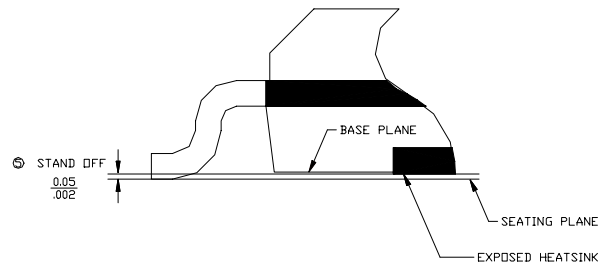

DETAIL A (3X)

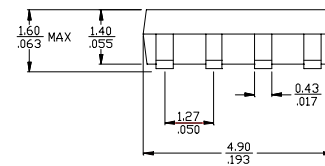

## Land Pattern

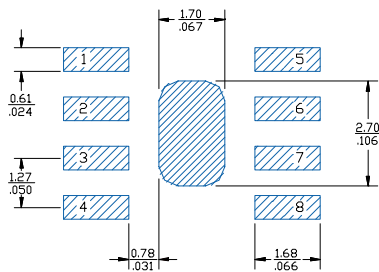

FUNCTION	PIN NO.
RF INPUT 1	1
GROUND	2-3
RF INPUT 2	4
RF OUTPUT 2 / BIAS 2	5
GROUND	6-7
RF OUTPUT 1 / BIAS 1	8

## Mounting Configuration

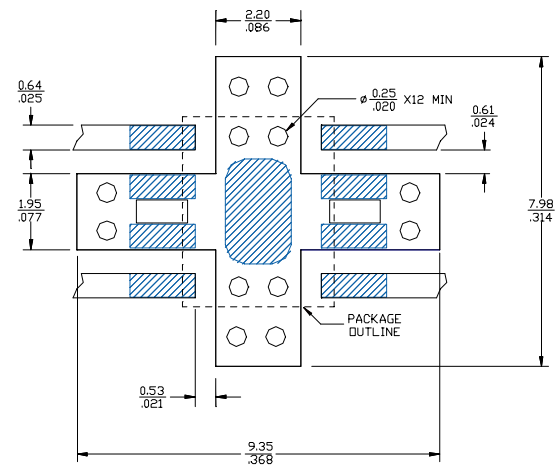

- Notes:
1. Ground vias are critical for thermal and RF grounding considerations.
  2. A minimum of 12 ground vias are required for 14 mil and 28 mil FR4 board.
  3. If your PCB design rules allow, ground vias should be placed under the land pattern for better RF and thermal performance. Otherwise ground vias should be placed as close to land pattern as possible.
  4. Trace width depends on PC board.
- Ⓢ 'Stand-off' is the distance between 'seating plane' and the 'exposed heatsink', or base plane of the package, which ever is lower.

## Typical Test Data

S-Parameters, single unmatched device, 50 Ohm system (2 per package), Vdd = +5 V, I<sub>ds</sub> = 150 mA, T = 22°C

Freq MHz	S11 Mag	Ang S11 Deg	Mag S21 dB	S21 Mag	Ang S21 Deg	S12 Mag	S12 Ang	S22 Mag	S22 Ang	K Value
300	.385	-46.99	15.18	5.74	157.04	.087	3.96	.089	-66.53	1.062
400	.374	-53.38	15.01	5.63	152.40	.087	-0.42	.070	-70.09	1.090
500	.373	-60.65	14.91	5.64	147.51	.088	-3.85	.055	-69.28	1.103
600	.373	-68.72	14.79	5.49	142.41	.088	-6.81	.043	-75.24	1.116
700	.376	-76.75	14.66	5.41	137.29	.088	-9.58	.036	-80.35	1.128
800	.380	-84.44	14.51	5.31	132.01	.088	-12.18	.031	-88.42	1.139
900	.383	-92.67	14.32	5.20	126.44	.087	-14.64	.028	-102.96	1.154
1000	.388	-101.02	14.22	5.14	121.35	.087	-17.00	.029	-115.17	1.159
1100	.394	-109.19	14.07	5.05	116.27	.087	-19.43	.029	-127.41	1.168
1200	.403	-116.98	13.89	4.95	111.15	.087	-21.69	.031	-124.69	1.176
1300	.413	-124.43	13.69	4.84	106.04	.086	-24.09	.033	-90.87	1.185
1400	.425	-131.56	13.49	4.72	101.02	.086	-26.33	.035	-93.85	1.198
1500	.438	-138.17	13.27	4.61	96.11	.085	-28.54	.034	-94.19	1.210
1600	.450	-144.35	13.04	4.49	91.32	.084	-30.63	.035	-91.92	1.224
1700	.463	-149.98	12.81	4.37	86.56	.084	-32.71	.035	-138.79	1.241
1800	.477	-155.15	12.58	4.25	81.99	.083	-34.68	.035	-131.58	1.253
1900	.489	-160.00	12.34	4.14	77.54	.082	-36.68	.036	-120.95	1.272
2000	.5	-164.30	12.11	4.03	73.22	.081	-38.35	.039	-112.03	1.289
2100	.509	-168.12	11.89	3.93	69.03	.081	-40.13	.042	-104.84	1.306
2200	.517	-171.72	11.68	3.84	64.90	.080	-41.73	.046	-99.68	1.322
2300	.523	-175.35	11.48	3.75	60.84	.079	-43.33	.049	-94.74	1.344
2400	.527	-175.60	11.28	3.67	56.75	.079	-44.95	.052	-92.05	1.366
2500	.528	-176.22	11.12	3.60	52.68	.078	-46.42	.053	-90.19	1.389
2600	.526	-173.37	10.97	3.54	48.71	.078	-48	.052	-88.68	1.418
2700	.523	-169.00	10.82	3.48	44.64	.078	-49.74	.050	-87.93	1.450
2800	.518	-164.08	10.68	3.42	40.45	.077	-51.48	.048	-88.08	1.486
2900	.513	-158.78	10.54	3.37	36.16	.077	-53.25	.042	-87.36	1.526
3000	.510	-153.07	10.40	3.31	31.82	.077	-55.21	.034	-82.55	1.561

This document contains information on a new product.  
Specifications and information are subject to change without notice.



**Caution!** ESD sensitive device.