



PRODUCT SPECIFICATION

Model No : CSQ-2842S/2841S

Descriptions:

- 0.28 Inch Quad Digit Display
- CSQ-2842: Common Anode
- CSQ-2841: Common Cathode
- Emitting Color: Super Bright Red



CUSTOMER APPROVED SIGNATURES	APPROVED BY	CHECKED BY	PREPARED BY

CHINA SEMICONDUCTOR CORPORATION
Address:2FL. NO.909,Chung-Cheng Road,
Chung-Ho City Taipei Hsien,Taiwan.

Tel:886-2-2223-9696
Fax:886-2-2223-9377

OPTO PLUS TECHNOLOGIES CO.,LTD
Address:696 Shun jiang Rd.,Ji Shan St.Shaoxing,
ZheJiang,China

Tel:86-0575-88623888
Fax:86-0575-88623112



Model No : CSQ-2842/2841S

Features -

1. 0.28 inch (7.0mm) digit height.
2. Case mold type.
3. RoHS compliant.
4. Low power consumption.
5. Easy mounting on P.C. board or socket.

Device Selection Guide -

Part No.	Chip		Description
	Material	Emitted Color	
CSQ-2842S	AlGaAs	Super Bright Red	Common Anode
CSQ-2841S	AlGaAs	Super Bright Red	Common Cathode

Package Dimensions -

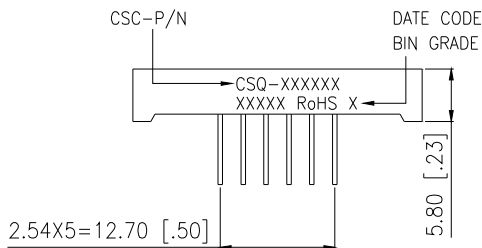
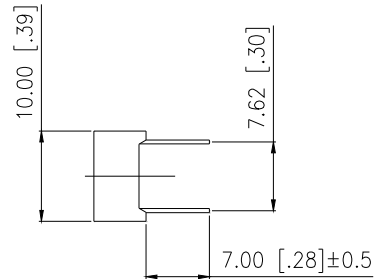
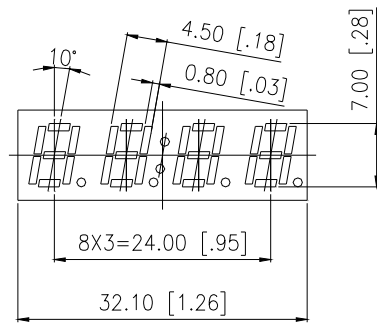

NOTE:

1. All pins are $\phi 0.45$ [.02"].
2. Dimension in millimeter (inch), and tolerance is ± 0.25 [.01] unless otherwise noted.



Model No : CSQ-2842/2841S

Internal Circuit Diagrams -

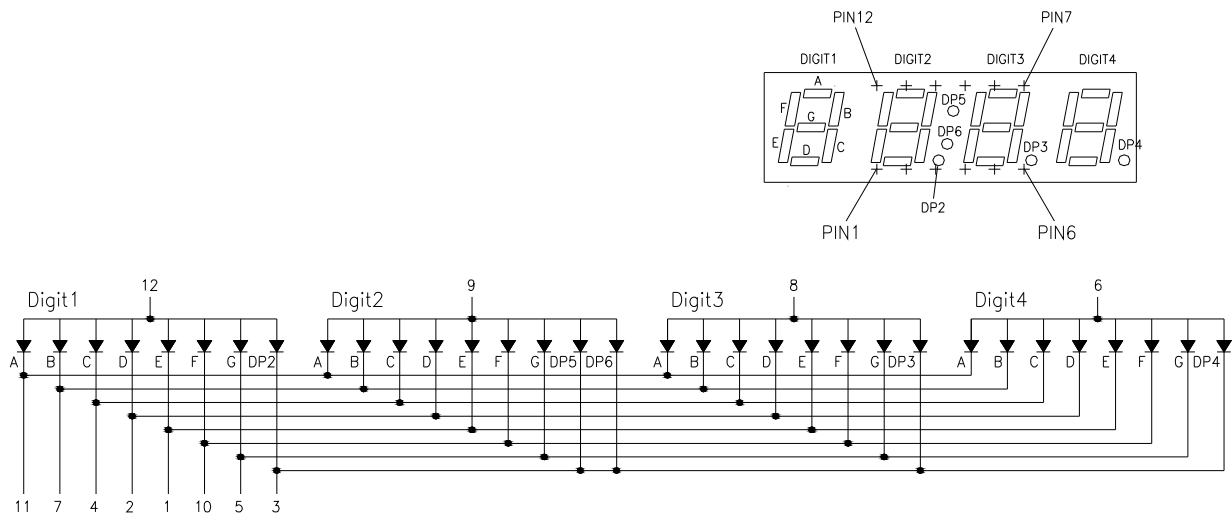

CSQ-2842 Common Anode
(CSQ-2841 Common Cathode)

Absolute Maximum Rating -

(Ta=25°C)

Parameter	Symbol	Rating	Unit
Power Dissipation Per Dice	P _{AD}	75	mW
Continuous Forward Current Per Dice	I _{AF}	30	mA
Peak Current Per Dice (duty cycle 1/10, 1kHz)	I _{PF}	120	mA
Derating Linear From 25°C Per Dice	-	0.42	mA/°C
Reverse Voltage Per Dice	V _R	5	V
Operating Temp.	T _{opr}	-35 ~ +85	°C
Storage Temp.	T _{stg}	-35 ~ +85	°C
Solder temperature 1/16 inch below seating plane for 3 seconds at 260°C			



Model No : CSQ-2842/2841S

■ Electro-optical Characteristics -

(Ta=25°C)

Parameter	Symbol	Min.	Typ.	Max.	Unit	Condition
Forward Voltage Per Segment	V_F	-	1.8	2.5	V	$I_F=20mA$
Luminous Intensity Per Segment	I_v	2400	6000	-	ucd	$I_F=10mA$
Peak Emission Wavelength	λ_p	-	660	-	nm	$I_F=20mA$
Dominant Wavelength	λ_d	-	644	-	nm	$I_F=20mA$
Spectrum Radiation Bandwidth	$\Delta \lambda$	-	20	-	nm	$I_F=20mA$
Reverse Current	I_R	-	-	100	μA	$V_R=5V$
Luminous Intensity Matching Ratio	I_V-m	-	-	2:1	-	$I_F=10mA$



Model No : CSQ-2842/2841S

■ Typical Electrical / Optical Characteristics Curves -

(Ta = 25°C Unless Otherwise Noted)

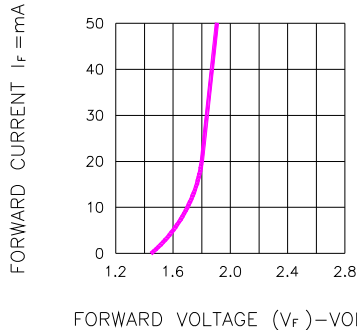

Fig.1 FORWARD CURRENT VS. FORWARD VOLTAGE

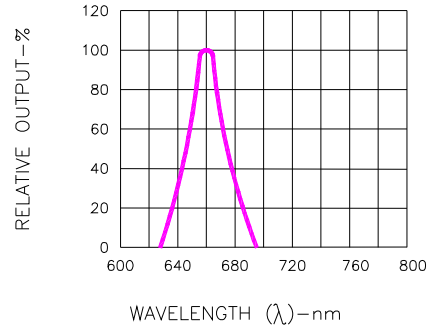

Fig.2 SPECTRAL RESPONSE

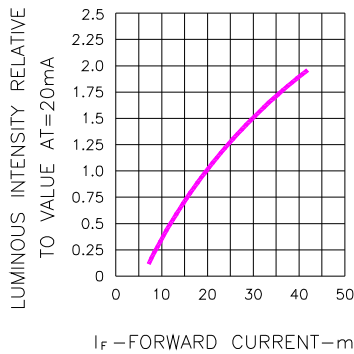

Fig.3 RELATIVE LUMINOUS INTENSITY VS. FORWARD CURRENT

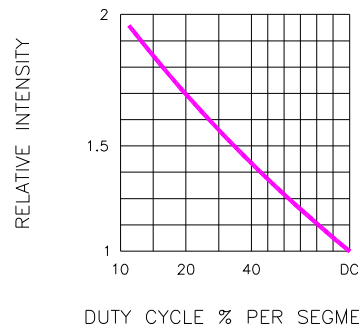

Fig.5 LUMINOUS INTENSITY VS. DUTY CYCLE

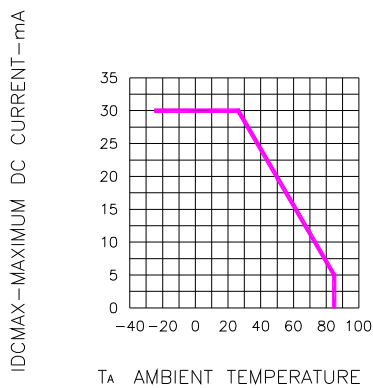

Fig.4 MAXIMUM ALLOWABLE DC CURRENT PER SEGMENT VS. A FUNCTION OF AMBIENT TEMPERATURE

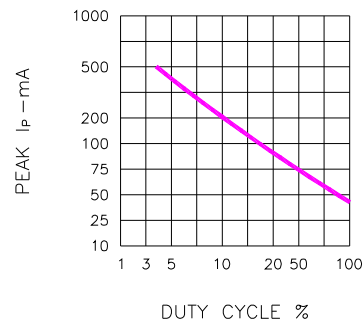

Fig.6 MAX PEAK CURRENT VS. DUTY CYCLE (REFRESH RATE f=1 KHz)



Model No: CSQ-2842/2841S

■ Package Dimensions

