

Description

Assemblies and combinations

Individual switches in combination with endcaps can easily be built into block assemblies by integrated snap pins. Spacers and housings can be integrated in any given sequence.

Special circuit boards

If you require a specially constructed PCB (special material, terminals, layout etc.), please consult the factory.

Stops

Cherry provides many standard combinations of rotation-limiting stops to help tailor our switches exactly to your application. In series PE stops can be installed in the field.

Colors and legends

The standard switch color is black. The wheels are black with white characters. Special colors for housings, wheels and legends are available upon request. We are able to print letters, symbols or figures according to individual requirements.

Circuitry

Standard circuitry is break-before-make (bbm). For make-before-break (mhb), please consult the factory.

Codes

For standard codes please refer to individual switch series. Further and special codes available upon request.

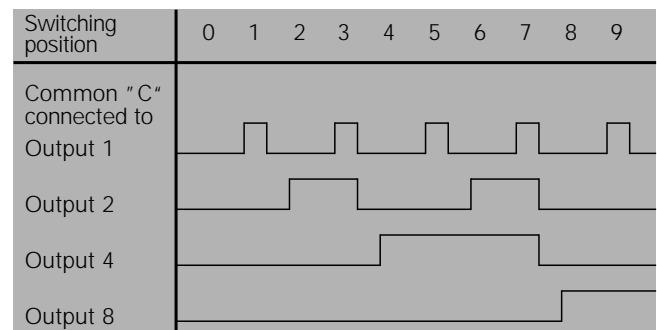

Mounting of components

Many standard codes are available with an extended PCB for mounting of diodes or resistors.

Truth tables

Table 1: BCD

| Readout-symbols | Common C connected to | | | |
|-----------------|-----------------------|---|---|---|
| | 1 | 2 | 4 | 8 |
| 0 | | | | |
| 1 | • | | | |
| 2 | | • | | |
| 3 | • | • | | |
| 4 | | | • | |
| 5 | • | | • | |
| 6 | | • | • | |
| 7 | • | • | • | |
| 8 | | | | • |
| 9 | • | | | • |

Table 2: Decimal

| Readout-symbols | Common C connected to | | | | | | | | | |
|-----------------|-----------------------|---|---|---|---|---|---|---|---|---|
| | 0 | 1 | 2 | 3 | 4 | 5 | 6 | 7 | 8 | 9 |
| 0 | • | | | | | | | | | |
| 1 | | • | | | | | | | | |
| 2 | | | • | | | | | | | |
| 3 | | | | • | | | | | | |
| 4 | | | | | • | | | | | |
| 5 | | | | | | • | | | | |
| 6 | | | | | | | • | | | |
| 7 | | | | | | | | • | | |
| 8 | | | | | | | | | • | |
| 9 | | | | | | | | | | • |

Table 4: Single pole repeating

| Readout-symbols | Common C connec. to | |
|-----------------|---------------------|---|
| | 1 | 2 |
| + 0 0 | • | |
| - 1 5 | | • |
| + 0 0 | • | |
| - 1 5 | | • |
| + 0 0 | • | |
| - 1 5 | | • |
| + 0 0 | • | |
| - 1 5 | | • |
| + 0 0 | • | |
| - 1 5 | | • |

Table 5: Hexadecimal

| Readout-symbols | Common C connected to | | | |
|-----------------|-----------------------|---|---|---|
| | 1 | 2 | 4 | 8 |
| 0 | | | | |
| 1 | • | | | |
| 2 | | • | | |
| 3 | • | • | | |
| 4 | | | • | |
| 5 | • | | • | |
| 6 | | • | • | |
| 7 | • | • | • | |
| 8 | | | | • |
| 9 | • | | | • |
| 10 (A) | • | • | | • |
| 11 (B) | • | | | • |
| 12 (C) | | • | | • |
| 13 (D) | • | • | | • |
| 14 (E) | • | | | • |
| 15 (F) | • | • | | • |

Table 8: BCD + complement

| Readout-symbols | Common C connec. to | | | | | | | |
|-----------------|---------------------|---|---|---|---|---|---|---|
| | 1 | 2 | 3 | 4 | 1 | 2 | 4 | 8 |
| 0 | | | | | • | • | • | • |
| 1 | • | | | | | | • | • |
| 2 | | • | | | | | • | • |
| 3 | • | • | | | | | • | • |
| 4 | | | • | | | | • | • |
| 5 | • | • | | | | | • | • |
| 6 | | • | • | | | | • | • |
| 7 | • | • | • | | | | • | • |
| 8 | | | | • | • | • | • | • |
| 9 | • | | | • | • | • | • | • |

Table 11: BCD complement

| Readout-symbols | Common C connec. to | | | |
|-----------------|---------------------|---|---|---|
| | 1 | 2 | 4 | 8 |
| 0 | • | • | • | • |
| 1 | | • | • | • |
| 2 | • | | • | • |
| 3 | | | • | • |
| 4 | • | • | | • |
| 5 | | • | | • |
| 6 | • | | | • |
| 7 | | • | | • |
| 8 | • | • | • | • |
| 9 | | • | • | • |

Serie PA

Characteristics

- Selector switches with very small dimensions for front-mounting.
- 10 or 16 switching positions. Housing black.
- Extended PCB for mounting of additional components available.
- Connection with Q.C. terminal or solder pins



Technical data

| | |
|--------------------------------------|---------------------------------------|
| Operating force | approx. 300 cN (with tactile feeling) |
| Contact resistance | 0,1 Ω max. |
| Insulating resistance | 10 ³ M Ω |
| Dielectric strength | 500 V- |
| Electrical rating (ohmic resistance) | 0,1 A/50 V= |
| Max. current (non switching current) | 1 A |
| Temperature | -20 bis +80 °C |
| Life cycle (mechanical) | 10 ⁶ operations |
| Shock | 50 g, 11 ms |
| Vibration | 15 g, 10-2000 Hz |
| Weight | approx. 2 g |

Materials

| | |
|-----------------------|--|
| Housing material | PPO (Noryl) |
| Contacts | WE alloy No. 2 |
| Printed circuit board | G 10 (FR 4) Glass filled epoxy, copper-plated Au over Ni |
| Mounting | Front-mounting, snap-in end-caps. Mounting of units through integrated pins. |
| Stops | Setting through factory only. |
| Terminals | Q.C. terminal gold-plated or solder pins. |

Dimensions in mm

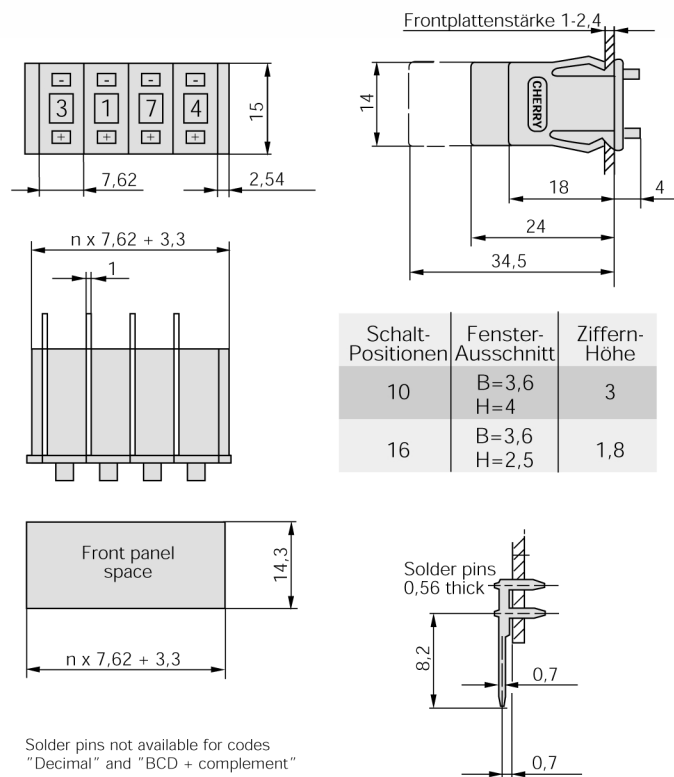

PCB terminals

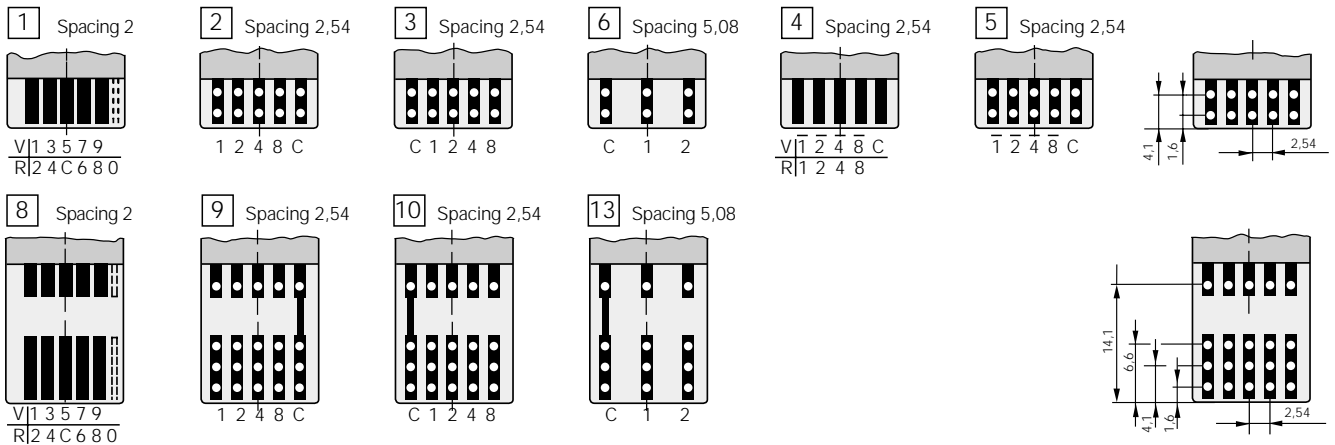

Codes b

| Switching position | Code Other codes on request | Readout | Truth table no (refer to page 3) | PCB-terminal no. | PCB short | PCB extended | Code |
|--------------------|--------------------------------|--------------|-------------------------------------|------------------|-----------|--------------|------|
| 10 | Dezimal | 0 - 9 | 2 | 1/8 | • | • | A |
| 10 | BCD | 0 - 9 | 1 | 2/9 | • | • | C |
| 10 | BCD Complement | 0 - 9 | 11 | 5 | • | • | E |
| 10 | BCD + Complement | 0 - 9 | 8 | 4 | • | • | F |
| 10 | Single pole repeating | +/- alt. | 4 | 6/13 | • | • | P |
| 16 | Hexadecimal | 0 - 15 | 5 | 3/10 | • | • | G |
| 16 | Hexadecimal | 0 - 9, A - F | 5 | 3/10 | • | • | H |

Terminals c

| Terminals | Index |
|----------------|-------|
| Q.C. terminals | A |
| Solder pins | F |

PCB versions d

| PCB version | Index |
|-------------|-------|
| short | 3 |
| extended | 4 |

Accessories for assembly

| Accessories for assembly | Stock codes |
|--------------------------|-------------|
| Endcap left | 609-0801 |
| Endcap right | 609-0799 |
| Housing 7,62 mm | 609-0797 |
| Spacer 2,54 mm | 609-0803 |

Example

| |
|---|
| PA: Series |
| C: Code BCD |
| A: Q.C. terminal |
| 3: PCB short |
| 4: 4 indiv. Switches, completely assembled with endcaps |
| 00: Standard version |

Ordering index

| a | b | c | d | e | f |
|----|---|---|---|---|----|
| PA | C | A | 3 | 4 | 00 |

e Single switch or qty. or assembled switches (1 - 9) with endcaps
 f Version (Standard = 00)

Series PB

Characteristics

- Selector switches with only 6 mm width for compact building of blocks with a larger number of modules.
- 10 switching positions.
- Housing black.
- Connection with solder pins



Technical data

| | |
|--------------------------------------|---------------------------------------|
| Operating force | approx. 300 cN (with tactile feeling) |
| Contact resistance | 0,1 Ω max. |
| Insulating resistance | 10 ⁹ M Ω |
| Dielectric strength | 500 V- |
| Electrical rating (ohmic resistance) | 0,1 A/50 V= |
| Max. current (non switching current) | 1A |
| Temperature | -20 bis +80 °C |
| Life cycle (mechanical) | 10 ⁶ operations |
| Shock | 50 g, 11 ms |
| Vibration | 15 g, 10-2000 Hz |
| Weight | approx. 2 g |

Materials

| | |
|-----------------------|-----------------------------------|
| Housing material | PPO (Noryl) |
| Contacts | WE alloy |
| Printed circuit board | FR 3, copper-plated Au over In |

Mounting

Front-mounting, snap-in end-caps. Mounting of units through integrated pins.

Stops Terminals

Setting through factory only.
Solder pins: 0,6 x 0,5 (spacing 2,54)

Dimensions in mm

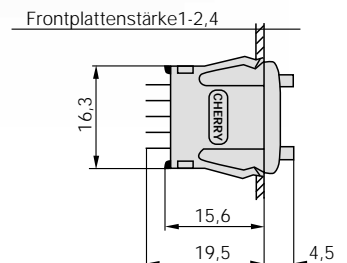
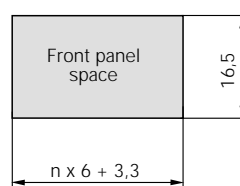
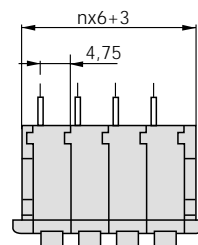
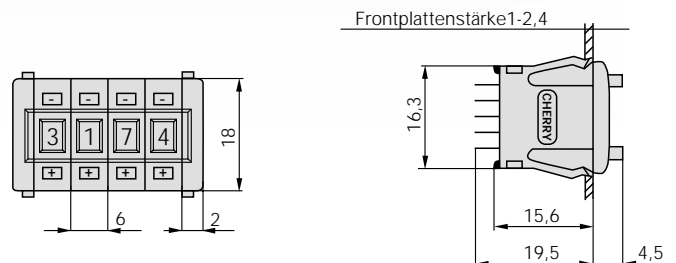

| Switching positions | Readout dimensions | Height of legends |
|---------------------|--------------------|-------------------|
| 10 | B=3 H=4 | 3 |

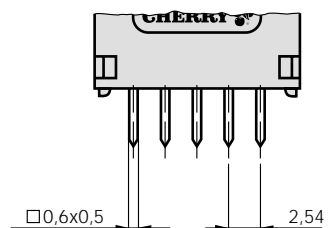

PCB terminals

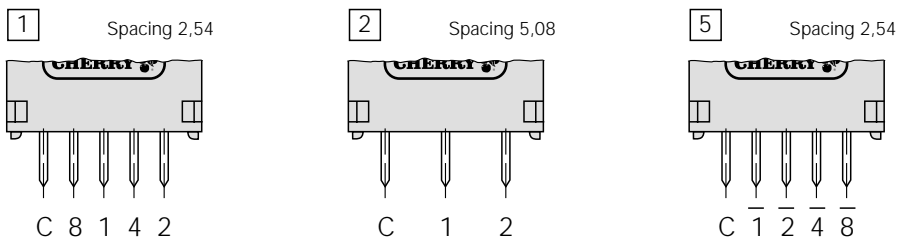

| Switching position | Code | Readout | Truth table no.- PCB terminal (refer to page 3) | PCB terminal no. | Code |
|--------------------|-----------------------|----------|---|------------------|------|
| 10 | BCD | 0 - 9 | 1 | 1 | C |
| 10 | BCD Complement | 0 - 9 | 11 | 5 | E |
| 10 | Single pole repeating | +/- alt. | 4 | 2 | P |

Terminals c

| Terminals | Index |
|-------------|-------|
| Solder pins | 1 |

PCB versions d

| PCB version | Code |
|---|------|
| PCB flush with housing with solder pins | E |

Accessories for assembly

Stock codes.

| | |
|--------------|----------|
| Endcap left | 609-1346 |
| Endcap right | 609-1347 |
| Housing 6 mm | 609-1348 |

Example

| |
|---|
| PB: Series |
| C: Code BCD |
| 1: Solder pins |
| E: PCB flush with housing |
| 4: 4 indiv. switches, completely assembled with endcaps |
| 00: Standard version |

Ordering index

| a | b | c | d | e | f |
|----|---|---|---|---|----|
| PB | C | 1 | E | 4 | 00 |

e Single switch or qty. or assembled switches (1 – 9) with endcaps
 f Version (Standard = 00)

Series PE

Characteristics

- Selector switches for easy snap in front-mounting.
- 10 or 16 switching positions. Housing black.
- For switches with 10 switching positions stops can be installed in the field.



Technical data

| | |
|--------------------------------------|--------------------------------------|
| Operating force | approx. 400cN (with tactile feeling) |
| Contact resistance | 0,1 Ω max. |
| Insulating resistance | 10 ³ M Ω |
| Dielectric strength | 500 V- |
| Electrical rating (ohmic resistance) | 0,1 A/50 V= |
| Max. current (non switching current) | 1 A |
| Temperature | -20 to +80 °C |
| Life cycle (mechanical) | 10 ⁶ operations |
| Shock | 50 g, 11 ms |
| Vibration | 15 g, 10-2000 Hz |
| Weight | approx. 4 g |

Materials

| | |
|-----------------------|---|
| Housing material | PPO (Noryl) |
| Contacts | WE alloy No. 2 |
| Printed circuit board | G 10 (FR 4), Glass filled epoxy, copper-plated Au over Ni |
| Mounting | Front-mounting, snap-in endcaps. Mounting of units through integrated pins. |

Stops

Setting through factory or afterwards in the field (10 switching positions). With 16 switching positions stops can only be set in the factory.

Terminals

Q.C. terminal gold-plated or solder pins.

Dimensions in mm

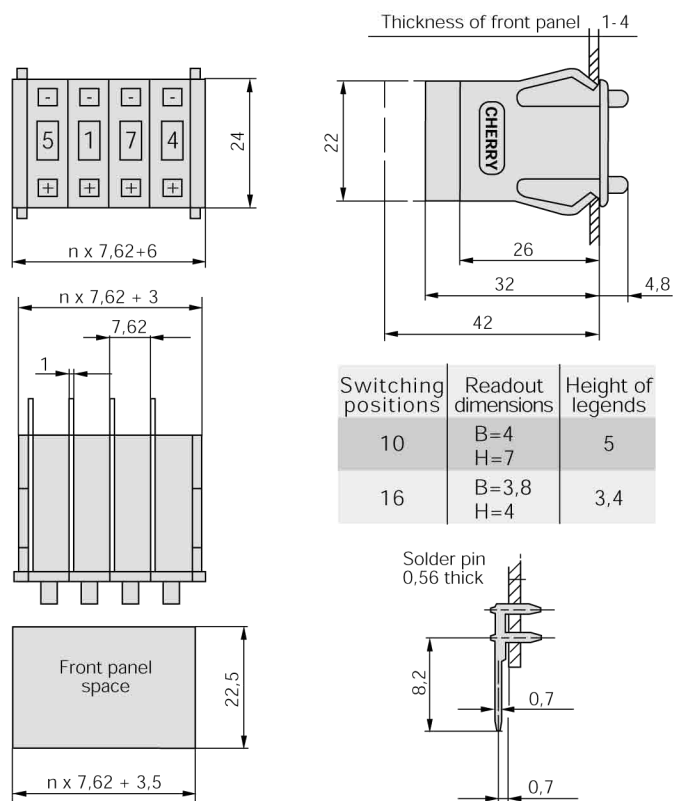

PCB terminals

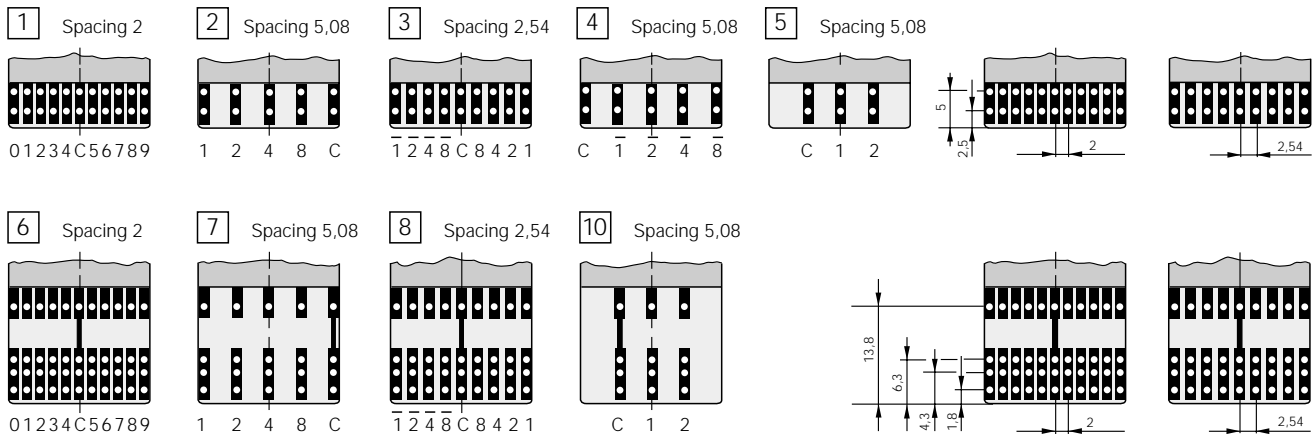

Codes b

| Switching position | Code Other codes on request | Readout- | Truth table- no. (refer to page 3) | PCB terminal no. | PCB short | PCB extended | Code |
|--------------------|--------------------------------|--------------|--|---------------------|-----------|--------------|------|
| 10 | Decimal | 0 - 9 | 2 | 1/6 | • | • | A |
| 10 | BCD | 0 - 9 | 1 | 2/7 | • | • | C |
| 10 | BCD Complement | 0 - 9 | 11 | 4 | • | • | E |
| 10 | BCD + Complement | 0 - 9 | 8 | 3/8 | • | • | F |
| 10 | Single pole repeating | +/- alt. | 4 | 5/10 | • | • | P |
| 16 | Hexadecimal | 0 - 15 | 5 | 2/7 | • | • | G |
| 16 | Hexadecimal | 0 - 9, A - F | 5 | 2/7 | • | • | H |

Terminals c

| Terminals | Index |
|---------------|-------|
| Q.C. terminal | A |
| Solder pins | F |

PCB versions d

| PCB version | Index |
|-------------|-------|
| short | 3 |
| extended | 4 |

Accessories for assembly

| Accessories for assembly | Stock codes |
|--|-------------|
| Endcap left | 609-0754 |
| Endcap right | 609-0756 |
| Housing 7,62 mm | 609-0752 |
| Spacer 2,54 mm | 609-0760 |
| Spacer 2,54 mm without snap-in brackets | 609-1609 |
| Stop pin | 607-0013 |

Example

| |
|---|
| PE: Series |
| C: Code BCD |
| A: Q.C. terminal |
| 3: PCB short |
| 4: 4 indiv. switches, completely assembled with endcaps |
| 00: Standard version |

Ordering index

| a | b | c | d | e | f |
|----|---|---|---|---|----|
| PE | C | A | 3 | 4 | 00 |

e Single switch or qty. or assembled switches (1 - 9) with endcaps
f Version (Standard = 00)

Connectors

Connectors make the connection of the selector switches very easy. The female connectors are available with and without flange. Terminals of the connectors either solder pin or solder lugs.



| Connector | | without flange | | with flange | |
|-----------|---------|----------------|-------------|-------------|-------------|
| Series | Code | Solder pins | Solder lugs | Solder pins | Solder lugs |
| PA | C,E,G,H | C2KO-P107 | C2KO-N107 | C2KF-P109 | C2KF-N109 |
| | F | C2KO-P108 | C2KO-N108 | C2KF-P110 | C2KF-N110 |
| | P | C2KO-P130 | C2KO-N130 | C2KF-P129 | C2KF-N129 |
| | A | C2RO-P8AD | C2RO-N8AD | C2RF-P8AD | C2RF-N8AD |
| PE | C,E,G,H | C2RO-P111 | C2RO-N111 | C2RF-P116 | C2RF-N116 |
| | F | C2RO-P113 | C2RO-N113 | C2RF-P118 | C2RF-N118 |
| | P | C2RO-P135 | C2RO-N135 | C2RF-P136 | C2RF-N136 |

| Series | with flange | | | | | | |
|--------|----------------------|-----|------|----|----|----|------|
| | without flange | | | | E | F | G |
| | Spacing A | B | C | D | | | |
| PA | 4 x 2,54 | 1,3 | 14,3 | 16 | 22 | 28 | 2,35 |
| PE | 10 x 2,0 8 x 2,54 | 1,3 | 22,3 | 24 | 30 | 36 | 2,35 |

With flange

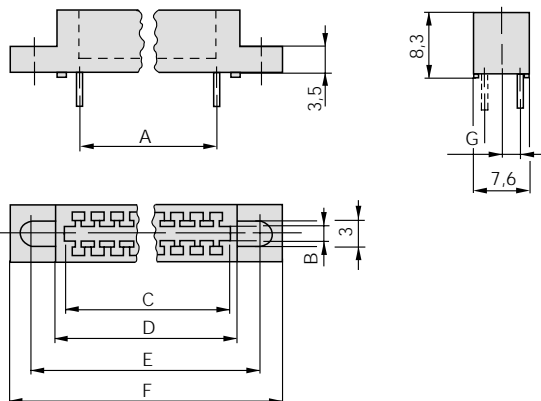

Without flange

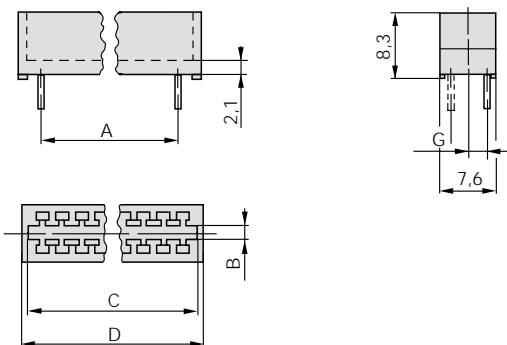

With solder pins

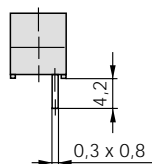

With solder lugs

