



## DRC Series

- 7.6 Amp AC Semiconductor Motor Controller
- Load voltage range up to 600 VAC
- Fits standard 35mm DIN Rail
- LED input status indicator
- AC or DC control
- Zero Voltage (resistive loads) or instantaneous (inductive loads) turn-on output
- C-UL-US Listed, CCC Certified, IEC Rated, CE & RoHS Compliant, Horsepower Rated
- Built-in Overvoltage Protection
- Ultra-efficient thermal management design (Patented)



Solicon DRC3 Series are Solid State Contactors intended for frequently switching on and off three phase loads up to **5 HP, 600 VAC 7.6 Amps**. They are available in both contactor versions **DRC3P** and reversing contactor versions **DRC3R**.

The Solicon Contactor DRC3P is available in either instantaneous turn-on (for Motor Control) or zero voltage turn-on (for Resistive Loads). It is available in either 2 or 3 controlled leg versions. The 2 legs control version is particularly suitable for motor control circuits where the neutral conductor is not utilized.

The Solicon Reversing Contactor DRC3R includes an **interlock** control that allows only off, forward and reverse operation in a safe mode while providing high space saving; it switches instantaneously upon application of the control voltage unless an

instantaneous change of direction is commanded, then it will delay the direction change by 100msec in order to prevent simultaneous forward and reverse operations.

All the models of Solicon DRC3 Series combine the benefits and advantages of a solid state contactor with the functionality and simplicity of use of an electromechanical contactor thanks to the proprietary **thermal management technology (Patented)** and complete electrical insulation (no grounding required); the **embedded auxiliary contacts**, normally open and/or normally closed, are intended to be used at 18-280VAC. Five different control voltages are available in order to cover most applications. All models include **overvoltage protection**.

### PRODUCT SELECTION

Control Voltage	Without Auxiliary Contact	1 NO+NC Auxiliary Contact	2 NO Auxiliary Contact
230 VAC	DRC3P48A400, DRC3R48A400	DRC3P48A411	DRC3P48A420, DRC3R48A420
120 VAC	DRC3P48B400, DRC3R48B400	DRC3P48B411	DRC3P48B420, DRC3R48B420
48 VAC/DC	DRC3P48C400, DRC3R48C400	DRC3P48C411	DRC3P48C420, DRC3R48C420
24 VAC/DC, 24 VAC	DRC3P48D400, DRC3R48D400	DRC3P48D411	DRC3P48D420, DRC3R48D420
24 VDC	DRC3R48E400		DRC3R48E420

### AVAILABLE OPTIONS

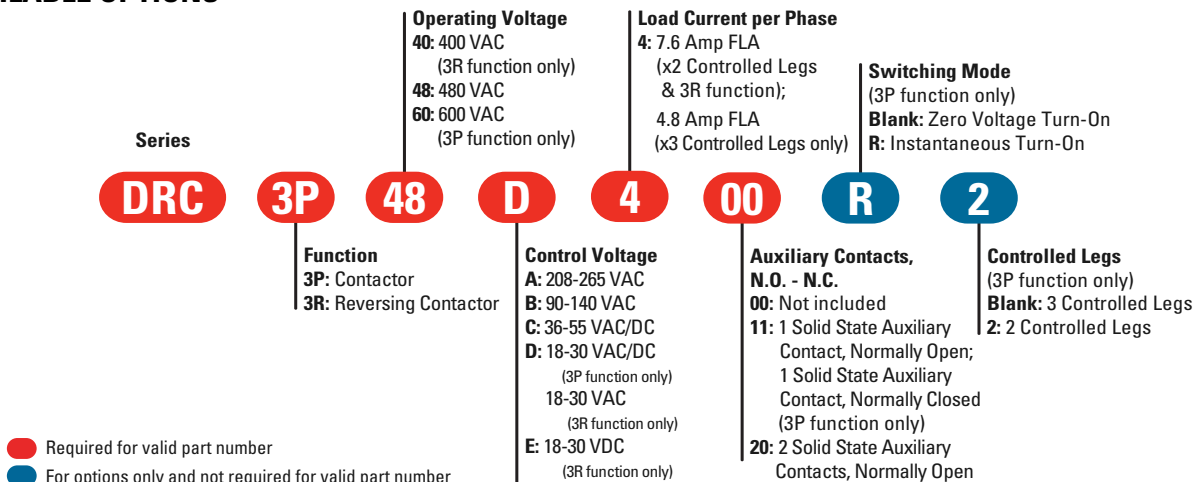

**OUTPUT SPECIFICATIONS <sup>(1)</sup>**

Description	DRC3P48x4x	DRC3P48x4x2	DRC3P60x4x	DRC3P60x4x2	DRC3R40x4x	DRC3R48x4x
Operating Voltage (47-63Hz) [Vrms]	48-530	48-530	48-600	48-600	48-415	48-510
Transient Overvoltage [Vpk] <b>(2)(3)</b>	1200	1200	1200	1200	1200	1600
Maximum Off-State Leakage Current @ Rated Voltage [mA <sub>rms</sub> ]	3.0	3.0	1.0	1.0	5.5	5.5
Maximum Off-State dv/dt @ Maximum Rated Voltage [V/μsec]	500	500	500	500	500	500
Load Current, General Use UL508 /AC51 @40°C [Arms] <b>(4)</b>	5	7.6	5	7.6	7.6	7.6
Load Current, Motor Controller UL508 /AC-53a @480VAC [Arms] <b>(4)</b>	4.8	7.6	4.8	7.6	7.6	7.6
Minimum Load Current [Arms]	0.15	0.15	0.15	0.15	0.15	0.15
Maximum Surge Current [Apk] 1 Cycle 60Hz	750	750	750	750	750	625
Maximum Surge Current [Apk] 1 Cycle 50Hz	716	716	716	716	716	597
Maximum I <sup>2</sup> t for Fusing (8.33msec)[A <sup>2</sup> sec]	2330	2330	2330	2330	2330	1621
Maximum I <sup>2</sup> t for Fusing (10msec)[A <sup>2</sup> sec]	2560	2560	2560	2560	2560	1779
Maximum On-State Voltage Drop @ Rated Current [Vpk]	1.35 per channel	1.35 per channel	1.35 per channel	1.35 per channel	1.5 per channel	1.5 per channel
Minimum Power Factor (with Maximum Load)	0.5	0.5	0.7	0.7	0.5	0.5
Ratings according to UL 508/IEC60947-4-2 [HP/kW]: 240 VAC	1/7.5	2/1.5	1/7.5	2/1.5	2/1.5	2/1.5
Ratings according to UL 508/IEC60947-4-2 [HP/kW]: 400 VAC	2/1.5	3/2.2	2/1.5	3/2.2	3/2.2	3/2.2
Ratings according to UL 508/IEC60947-4-2 [HP/kW]: 480 VAC	3/2.2	5/3.7	3/2.2	5/3.7	-	5/3.7
Motor Ratings @ 600 VAC [HP/kW]	-	-	3/2.2	5/3.7	-	-

**INPUT SPECIFICATIONS <sup>(1)</sup>**

Description	Option A	Option B	Option C	Option D	Option E
Control Voltage Range <b>(5)</b>	208-265 VAC	90-140 VAC	36-55 VAC / VDC	18-30 VAC / VDC	18-30 VDC
Minimum Turn-On Voltage <b>(6)</b>	208 VAC	90 VAC	36 VAC / VDC	18 VAC / VDC	18 VDC
Must Turn-Off Voltage	40 VAC	10 VAC	4 VAC / VDC	4 VAC / VDC	4 VDC
Minimum Input Current (for on-state) [mA]	6.1	7.5	12	12.5	12.5
Maximum Input Current [mA]	8	13	20	32	32
Nominal Input Impedance [Ohms]	33k	12.5k	3k	0.93k	0.93k
Maximum Delay to Turn-On [msec] <b>(7)</b>	30	30	30	20	100 ± 30
Maximum Turn-Off Time [msec] <b>(8)</b>	40	40	40	30	20

**SOLID STATE AUXILIARY CONTACTS <sup>(1)</sup>**

Description	Normally Open Suffix 2x,1x	Normally Closed Suffix x1
Operating Voltage Range (47-63Hz) [Vrms] <b>(9)</b>	18-280	18-280
Transient Overvoltage [Vpk]	600	600
Maximum Load Current [Arms]	1	1
Minimum Load Current [mA]	5	5
Maximum Surge Current [Apk] 1 Cycle 60Hz	40	40
Maximum Surge Current [Apk] 1 Cycle 50Hz	38	38
Maximum I <sup>2</sup> t for Fusing (8.33msec)[A <sup>2</sup> sec]	6.7	6.7
Maximum I <sup>2</sup> t for Fusing (10msec)[A <sup>2</sup> sec]	7.2	7.2
Maximum Off-State Leakage Current @ Rated Voltage [mA <sub>rms</sub> ]	0.1	5 mA
Minimum Off-State dv/dt @ Maximum Rated Voltage [V/μsec]	500	500
Maximum Delay to Turn-On [msec] <b>(7)</b>	30	80
Maximum Turn-Off Time [msec]	40	40

**GENERAL SPECIFICATIONS <sup>(1)</sup>**

Description	Parameters
Dielectric Strength, Input/Output/Base (50/60Hz) <b>(10)</b>	3750 Vrms
Minimum Insulation Resistance (@ 500 VDC)	10 <sup>9</sup> Ohms
Maximum Capacitance, Input/Output	20 pF
Ambient Operating Temperature Range <b>(11)</b>	-30 to 80 °C
Ambient Storage Temperature Range	-40 to 100 °C
Weight (typical)	2 Controlled Legs (6.9 oz [197 g]) / 3 Controlled Legs (8.0 oz [228 g])
Housing Material	UL94 V-0
Housing Color	Black and Light Gray
LED Status Indicator (color) <b>(12)</b>	Forward (Green) / Reverse (Amber)
Short Circuit Current Rating <b>(13)</b>	100kA
MTBF (Mean Time Between Failures) at 40°C ambient temperature <b>(14)</b>	1,398,000 hours (159 years)
MTBF (Mean Time Between Failures) at 60°C ambient temperature <b>(14)</b>	390,000 hours (44 years)
Pollution Degree	2
Protection Degree <b>(15)</b>	IP20
Humidity	85% non-condensing
Control and Auxiliary Contact Terminal Screw Torque Range (in-lb/Nm)	12 / 1.36
Load Terminal Screw Torque Range (in-lb/Nm)	15 / 1.7
Input Terminal Wire Capacity	18-12 AWG (IEC 1-4 mm <sup>2</sup> ) (stranded /solid)
Output Terminal Wire Capacity	18-10 AWG (IEC 1-6 mm <sup>2</sup> ) (stranded /solid)

**MECHANICAL SPECIFICATIONS (1)**

Tolerances: ±0.02 in / 0.5 mm  
 All dimensions are in: inches [millimeters]

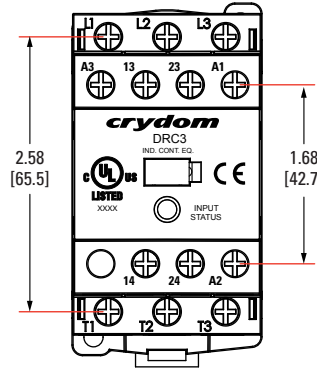
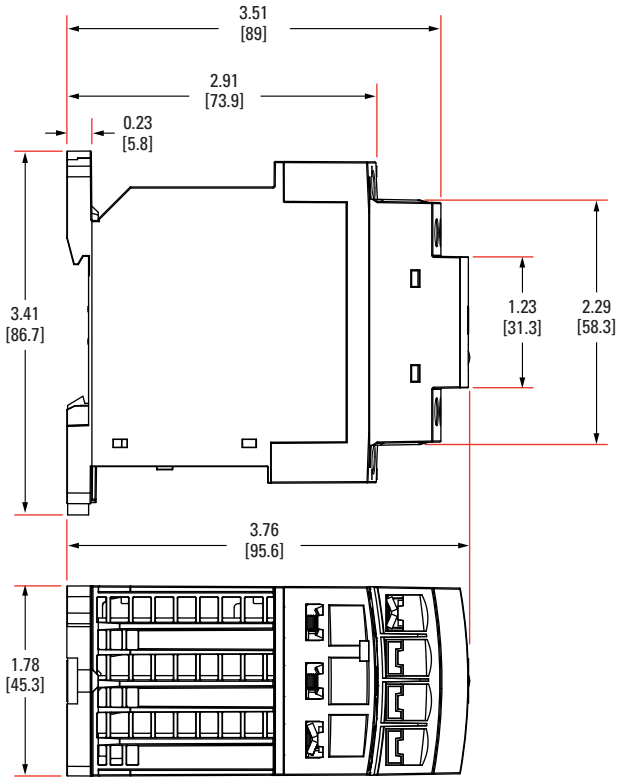

**TERMINAL SCREW TYPE**

Top/Bottom view (Fig. 1)

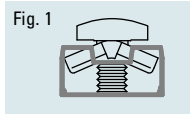

**THERMAL DERATE INFORMATION (16)**

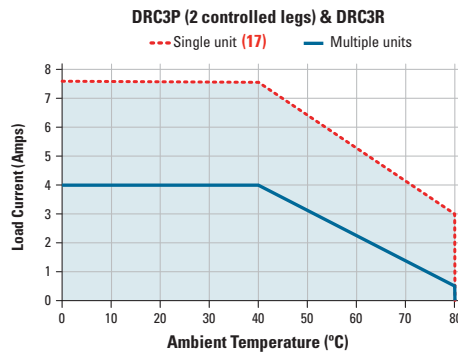
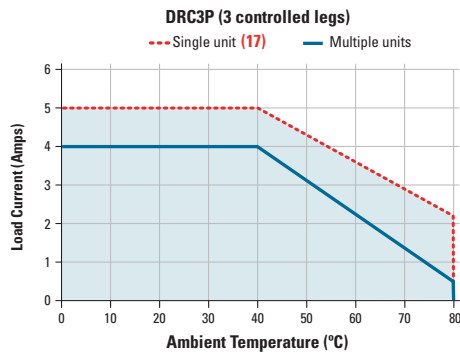

**SWITCHING FREQUENCY/LOAD CHARACTERISTIC FOR ALL DEVICES**

- $I_L$  : Load Operating Current
- $I_R$  : Rated Full Load Current [FLA]
- $I_D$  : Direct-On-Line Inrush Current
- $t_L$  : Load Operating Current Time
- $t_D$  : Direct-On-Line Inrush Current Time
- $t_c$  : Cycle Time
- $t_{on}$  : On Time
- $t_{off}$  : Off Time

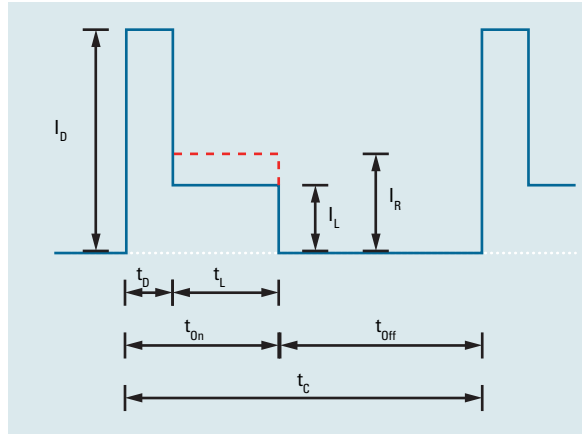

**MAXIMUM ALLOWABLE NUMBER OF STARTS PER HOUR DEPENDING ON THE STARTING TIME  $t_D$  AND THE ON PERIOD  $t_{on}$  (as for standard IEC 60947-4-2) FOR ALL DEVICES**

Without overload relay (limit given by the contactor itself)

**Table 1**

- High inrush current ( $I_D/I_R = 4$  to  $7.2$ )
- Full load ( $I_L/I_R = 1$ )

$t_D$ (sec)	$t_{on}$ (sec)			
	0.1	1	10	100
0.05	5000	2700	350	35
0.1	3200	1950	350	35
0.2	-	950	320	35
0.4	-	500	280	35
0.8	-	290	160	35
1.6	-	-	110	30
3.2	-	-	75	25

**Table 2**

- High inrush current ( $I_D/I_R = 4$  to  $7.2$ )
- 60% load ( $I_L/I_R = 0.6$ )

$t_D$ (sec)	$t_{on}$ (sec)			
	0.1	1	10	100
0.05	6000	3550	350	35
0.1	4100	3000	350	35
0.2	-	1300	350	35
0.4	-	700	320	35
0.8	-	400	320	35
1.6	-	-	125	35
3.2	-	-	90	35

**Table 3**

- Low inrush current ( $I_D/I_R < 4$ )
- Full load ( $I_L/I_R = 1$ )

$t_D$ (sec)	$t_{on}$ (sec)			
	0.1	1	10	100
0.05	7450	3200	350	35
0.1	4050	2100	350	35
0.2	-	1200	350	35
0.4	-	650	320	35
0.8	-	350	280	35
1.6	-	-	180	35
3.2	-	-	90	35

**Table 4**

- Low inrush current ( $I_D/I_R < 4$ )
- 60% load ( $I_L/I_R = 0.6$ )

$t_D$ (sec)	$t_{on}$ (sec)			
	0.1	1	10	100
0.05	9000	3550	350	35
0.1	5400	3550	350	35
0.2	-	1700	350	35
0.4	-	850	350	35
0.8	-	560	350	35
1.6	-	-	240	35
3.2	-	-	180	35

With overload relay (limit given by the overload relay itself)

**Table 5**

- High inrush current ( $I_D/I_R = 4$  to  $7.2$ )
- Full load ( $I_L/I_R = 1$ )

$t_D$ (sec)	$t_{on}$ (sec)			
	0.1	1	10	100
0.05	2200	1650	330	30
0.1	1500	1000	280	28
0.2	-	550	255	26
0.4	-	250	150	24
0.8	-	80	60	20
1.6	-	-	40	16
3.2	-	-	-	-

**Table 6**

- High inrush current ( $I_D/I_R = 4$  to  $7.2$ )
- 60% load ( $I_L/I_R = 0.6$ )

$t_D$ (sec)	$t_{on}$ (sec)			
	0.1	1	10	100
0.05	2800	1800	320	35
0.1	1700	1300	310	32
0.2	-	650	290	30
0.4	-	300	200	26
0.8	-	200	90	25
1.6	-	-	65	25
3.2	-	-	-	-

**Table 7**

- Low inrush current ( $I_D/I_R < 4$ )
- Full load ( $I_L/I_R = 1$ )

$t_D$ (sec)	$t_{on}$ (sec)			
	0.1	1	10	100
0.05	5150	2800	260	35
0.1	2850	1920	250	34
0.2	-	1100	250	33
0.4	-	600	200	32
0.8	-	320	200	30
1.6	-	-	120	25
3.2	-	-	75	20

**Table 8**

- Low inrush current ( $I_D/I_R < 4$ )
- 60% load ( $I_L/I_R = 0.6$ )

$t_D$ (sec)	$t_{on}$ (sec)			
	0.1	1	10	100
0.05	5600	3200	350	35
0.1	3200	2700	350	35
0.2	-	1400	350	35
0.4	-	700	350	35
0.8	-	350	280	35
1.6	-	-	170	35
3.2	-	-	80	25

**SHORT CIRCUIT AND OVERLOAD PROTECTION FOR ALL DEVICES**  
(Conforming to the IEC60947-4-2 and UL508)

IEC standard 60947-4-1 make a distinction between two different types of protection, (called “coordination”), which are designated types “1” and “2”. Any short-circuit that occurs is cleared safely by either type of coordination. The only difference between the 2 categories concerns the extent of the SSR damage caused by the short-circuit.

**Type “1”** coordination requires that in the event of a short-circuit, the Solid State Contactor does not endanger personnel or installations, but permanent damage to the SSC is permissible. In this case the SSC may need to be replaced. For this type of co-ordination, the use of fusing or circuit breakers adequate to protect the system and wiring from short circuits, (but not specifically considering SSC protection), can be used.

**Type “2”** coordination requires that under a short-circuit condition, the circuit is interrupted, the SSC does not endanger persons or installations, and in addition the SSR will be able to operate after the fault condition is repaired.

**Type of coordination 1**

**Protection by Thermal Magnetic Circuit Breaker (18)**

Nominal Motor Current	Thermal Magnetic Circuit Breaker (Schneider Electric)	Solid State Contactor 2 controlled legs	Solid State Contactor 3 controlled legs	Solid State Contactor Reversing
0.40-0.63 A	GV2ME04 / GV2P04	DRC3Pxx4x2	DRC3Pxx4x	DRC3Rxx4x
0.63-1 A	GV2ME05 / GV2P05	DRC3Pxx4x2	DRC3Pxx4x	DRC3Rxx4x
1-1.6 A	GV2ME06 / GV2P06	DRC3Pxx4x2	DRC3Pxx4x	DRC3Rxx4x
1.6-2.5 A	GV2ME07 / GV2P07	DRC3Pxx4x2	DRC3Pxx4x	DRC3Rxx4x
2.5-4 A	GV2ME08 / GV2P08	DRC3Pxx4x2	DRC3Pxx4x	DRC3Rxx4x
4-6.3 A	GV2ME10 / GV2P10	DRC3Pxx4x2	DRC3Pxx4x (up to 4.8A)	DRC3Rxx4x
6.3-10 A	GV2ME14 / GV2P14	DRC3Pxx4x2 (up to 7.6A)	-	DRC3Rxx4x (up to 7.6A)

**Protection by overload relays and fuses (18)**

Nominal Motor Current	Overload Relay (Schneider Electric)	Class gG fuses (example from Littelfuse)	Solid State Contactor 2 controlled legs	Solid State Contactor 3 controlled legs	Solid State Contactor Reversing
0.40-0.63 A	LRD04	CY14X51G16	DRC3Pxx4x2	DRC3Pxx4x	DRC3Rxx4x
0.63-1 A	LRD05	CY14X51G16	DRC3Pxx4x2	DRC3Pxx4x	DRC3Rxx4x
1-1.6 A	LRD06	CY14X51G25	DRC3Pxx4x2	DRC3Pxx4x	DRC3Rxx4x
1.6-2.5 A	LRD07	CY14X51G25	DRC3Pxx4x2	DRC3Pxx4x	DRC3Rxx4x
2.5-4 A	LRD08	CY14X51G25	DRC3Pxx4x2	DRC3Pxx4x	DRC3Rxx4x
4-6.3 A	LRD10	CY14X51G40	DRC3Pxx4x2	DRC3Pxx4x (up to 4.8A)	DRC3Rxx4x
6.3-10 A	LRD14	CY14X51G40	DRC3Pxx4x2 (up to 7.6A)	-	DRC3Rxx4x (up to 7.6A)

**Type of coordination 2**

**Protection by overload relays and fuses (18)**

Nominal Motor Current	Overload Relay (Schneider Electric)	Semiconductor fuses with less than 1621A2S			Solid State Contactor 2 controlled legs	Solid State Contactor 3 controlled legs	Solid State Contactor Reversing
		Littlefuse	SIBA (Cylindric)	Ferraz (Cylindric)			
0.40-0.63 A	LRD04	LA50QS40-4	50.058.06.40	A093909	DRC3Pxx4x2	DRC3Pxx4x	DRC3Rxx4x
0.63-1 A	LRD05	LA50QS40-4	50.058.06.40	A093909	DRC3Pxx4x2	DRC3Pxx4x	DRC3Rxx4x
1-1.6 A	LRD06	LA50QS40-4	50.058.06.40	A093909	DRC3Pxx4x2	DRC3Pxx4x	DRC3Rxx4x
1.6-2.5 A	LRD07	LA50QS40-4	50.058.06.40	A093909	DRC3Pxx4x2	DRC3Pxx4x	DRC3Rxx4x
2.5-4 A	LRD08	LA50QS40-4	50.058.06.40	A093909	DRC3Pxx4x2	DRC3Pxx4x	DRC3Rxx4x
4-6.3 A	LRD10	LA50QS40-4	50.058.06.40	A093909	DRC3Pxx4x2	DRC3Pxx4x (up to 4.8A)	DRC3Rxx4x
6.3-10 A	LRD14	LA50QS40-4	50.058.06.40	A093909	DRC3Pxx4x2 (up to 7.6A)	-	DRC3Rxx4x (up to 7.6A)

**Note:** All the Schneider Electric Thermal magnetic circuit breakers GV2 family (GV2ME and GV2P) is fully mechanical compatible with the DRC contactor using the GV2AF3 connection block. All the Schneider Electric Overload relay LRD family is fully mechanical compatible with the DRC contactor without the need of any adapter. The DRC Series can accept the LAD7C1 module (pre-wiring kit allowing direct connection of the NC contact of relay LRD to the contactor)

**WIRING AND BLOCK DIAGRAM**

**DRC3P CONTACTOR (19)**

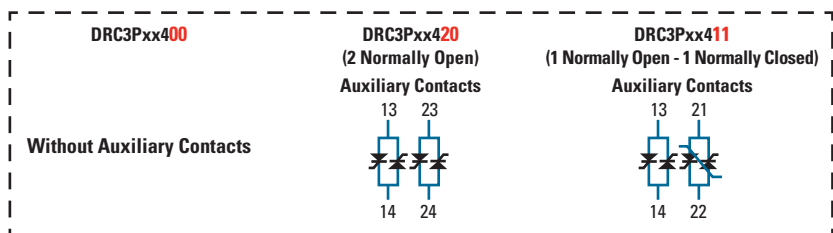
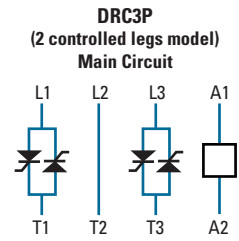
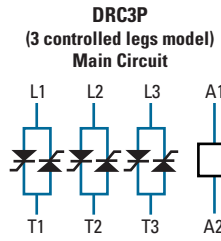
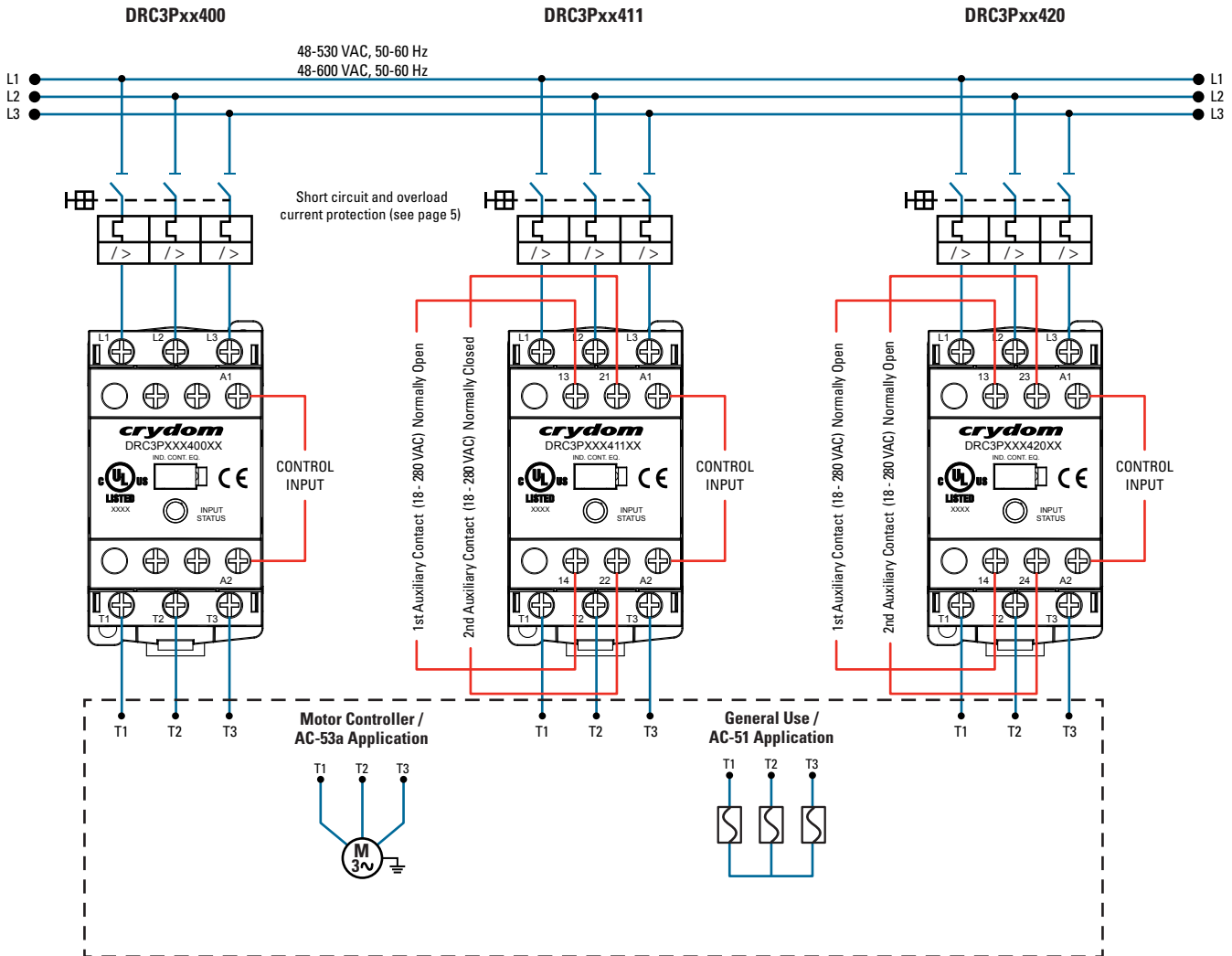

**DRC3R REVERSING CONTACTOR (20)**

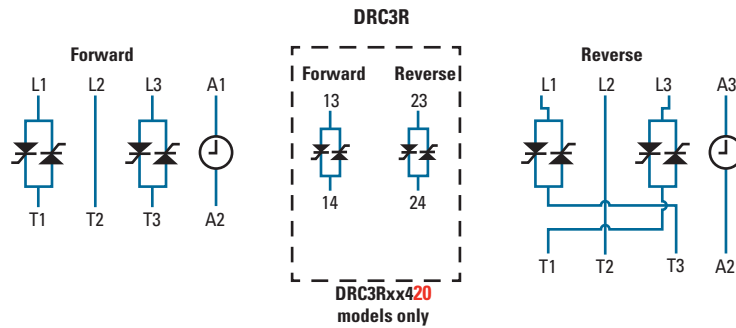
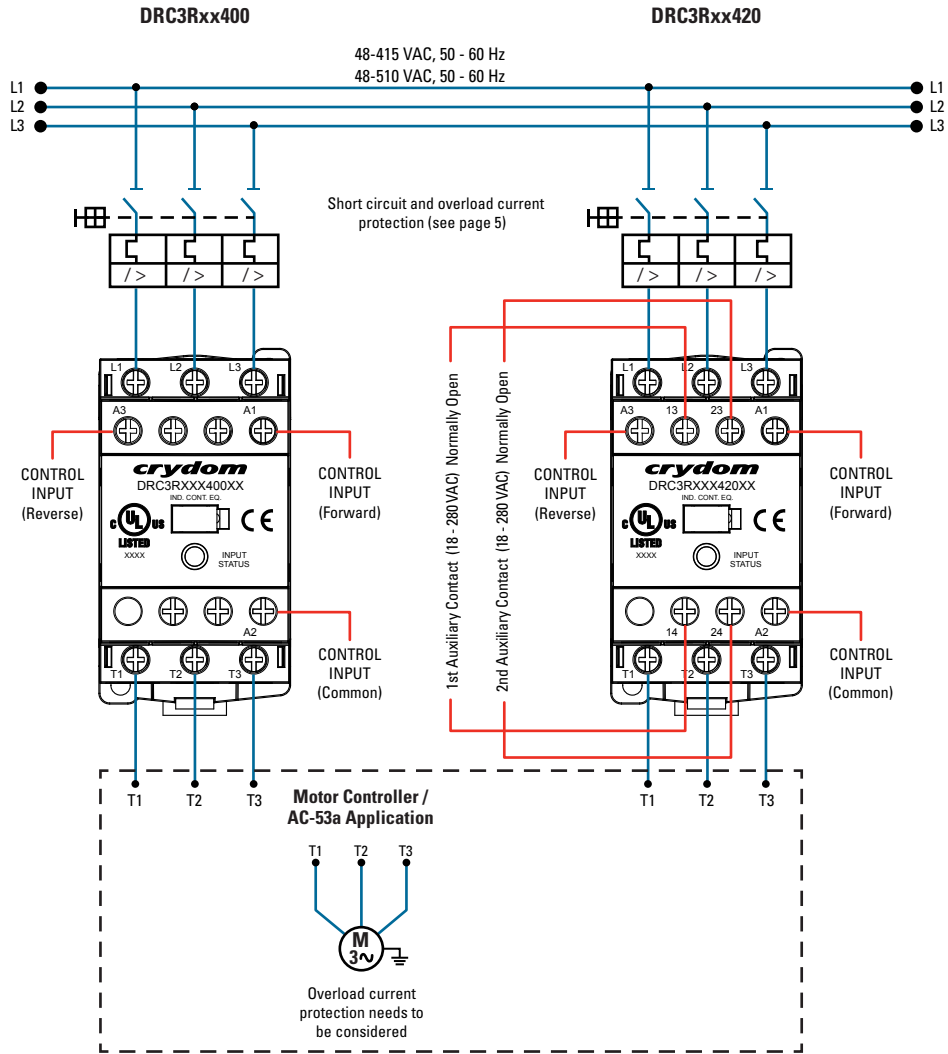

**TIMING DIAGRAM**

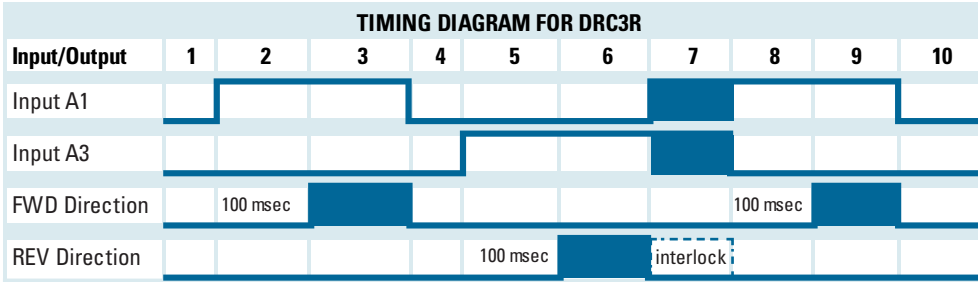

STEP	DESCRIPTION
1, 4, 10	Initial Condition. A1 & A3 open
2	A1 is activated, FWD Output waits for 100msec
3, 9	FWD direction is activated
4	A1 changes to off. FWD Output is disabled at the same time
5	A3 is activated. REV Outputs waits for 100msec
6	REV direction is On
7	Interlock function is activated. REV is disabled due to A1 & A3 both being active
8	A3 is open, A1 is closed, activation delayed 100msec

Input A1	Input A3	Output	
		FWD	REV
Open	Open	Off	Off
Close	Open	On	Off
Open	Close	Off	On
Close	Close	Off	Off

**AGENCY APPROVALS**

**Agency Approvals**

Certification in accordance with:  
 United States Standard for Industrial Control Equipment - UL 508 and  
 Canadian Standard Association for Industrial Control Equipment – C22.2 No. 14.  
 China Compulsory Certification for AC Semiconductor Motor Controller-GB14048.6-2008

DRC3 series conforms to the harmonized EN standard EN/IEC 60947-4-2

Electromagnetic Compatibility:  
 IEC 61000-4-2 : Electrostatic Discharge – Level 3  
 IEC 61000-4-4 : Electrically Fast Transients – Level 3  
 IEC 61000-4-5 : Electrical Surges – Level 3

Vibration Resistance:  
 IEC 60068-2-6 : Amplitude Range 10-55 Hz, Displacement 0.75mm

Shock Resistance:  
 IEC 60068-2-27 : Peak Acceleration 15g, Duration 11msec.



UL LISTED



CCC (Only DRCx40x4x & DRCx48x4x)



CE



IEC







RoHS



EMC



**ACCESSORIES FOR ALL DEVICES**

Recommended Accessories				
Motor Nominal Current	Bimetal Overload Relay	Electronic Overload Relay	Thermal Magnetic Circuit Breaker (Push Button)	Thermal Magnetic Circuit Breaker (Selector)
0.40 - 0.63 A	LRD04	LR97 D015xx	GV2ME04	GV2P04
0.63 - 1 A	LRD05	LR97 D015xx	GV2ME05	GV2P05
1 - 1.6 A	LRD06	LR97 D07xx	GV2ME06	GV2P06
1.6 - 2.5 A	LRD07	LR97 D07xx	GV2ME07	GV2P07
2.5 - 4 A	LRD08	LR97 D07xx	GV2ME08	GV2P08
4 - 6.3 A	LRD10	LR97 D25xx	GV2ME10	GV2P10
6.3 - 10 A	LRD14	LR97 D25xx	GV2ME14	GV2P14
Fully compatible with Schneider Electric thermal overload relays & thermal magnetic circuit breakers				

**Note:** All the Schneider Electric Thermal magnetic circuit breakers GV2 family (GV2ME and GV2P) is fully mechanical compatible with the DRC contactor using the GV2AF3 connection block. All the Schneider Electric Overload relay LRD family is fully mechanical compatible with the DRC contactor without the need of any adapter. The DRC Series can accept the LAD7C1 module (pre-wiring kit allowing direct connection of the NC contact of relay LRD to the contactor) When the LAD7C1 module is used, the common terminal for the control input is not anymore the "A2" terminal of DRC but it is the "96" terminal of the overload relay.

**ID Marker Strips**  
**CNLB, CNLN, CNL2**

Packages of 10 plastic strips comprising 10 individual markers which can be placed for easy identification during the use of multiple units.

**Blank Strips**  
Part no.: CNLB



**Numbered 1 to 10 Strips**  
Part no.: CNLN



**Numbered 11 to 20 Strips**  
Part no.: CNL2

**GENERAL NOTES**

- (1) All parameters at 25°C unless otherwise specified.
- (2) For DRC3P relay will self trigger between 900-1200V, Not suitable for capacitive loads.
- (3) For DRC3R over rated voltage internal self protection will be activated increasing leakage current.
- (4) Mounted in the Vertical position.
- (5) On DRC3R models the range for option D is 18-30 VAC.
- (6) For low temperature operation consider nominal control voltage.
- (7) For DRC3R the turn-on time is 100msec ± 30msec.
- (8) When is complete removed the control signal. For DRC3R the turn-off time is 20msec.
- (9) Operating voltage range 18-30 VDC is also valid when used to latch the DRC contactor control input.
- (10) For input to auxiliary output the dielectric strength is 2.5kV.
- (11) UL approval up to 40°C surrounding temperature.
- (12) Reverse Amber Indicator is for DRC3R models only.
- (13) 100kA, 480VAC, when protected with CC class fuses rated 600VAC, 20 A or equivalent.
- (14) All parameters at 50% power rating and 100% duty cycle (contact Crydom tech support for detailed report).
- (15) IP20 rating is not associated with the UL approval.
- (16) Derate information is valid when DCR contactors are used with or without accessories, installed on top and/or bottom.
- (17) Minimum spacing to obtain max. current is 22mm between adjacent units.
- (18) Combinations of these Protective Devices and Solid State Contactor have not been evaluated by UL.
- (19) For DRC3P models external loads can be connected in parallel to the control input.
- (20) DRC3R internal safety interlock circuit prevents the product to work if any leakage current is present in the control input currently not enabled.

Rev. 083117  
ECN 20312

**⚠ DANGER / PELIGRO / DANGER /GEFAHR / PERICOLO / 危險**

<p><b>HAZARD OF ELECTRIC SHOCK, EXPLOSION, OR ARC FLASH.</b></p> <ul style="list-style-type: none"> <li>• Disconnect all power before installing or working with this equipment.</li> <li>• Verify all connections and replace all covers before turning on power.</li> </ul> <p><b>Failure to follow these instructions will result in death or serious injury.</b></p>	<p><b>RIESGO DE DESCARGA ELECTRICA O EXPLOSION.</b></p> <ul style="list-style-type: none"> <li>• Desconectar todos los suministros de energia a este equipo antes de trabajar con este equipo.</li> <li>• Verificar todas las conexiones y colocar todas las tapas antes de energizar el equipo.</li> </ul> <p><b>El incumplimiento de estas instrucciones puede provocar la muerte o lesiones serias.</b></p>	<p><b>RISQUE DE DESCARGE ELECTRIQUE OU EXPLOSION</b></p> <ul style="list-style-type: none"> <li>• Eteindre toutes les sources d'énergie de cet appareil avant de travailler dessus de cet appareil</li> <li>• Vérifier tous connections, et remettre tous couverts en olace avant de mettre sous</li> </ul> <p><b>De non-suivi de ces instructions provoquera la mort ou des lésions sérieuses.</b></p>	<p><b>GEFAHR EINES ELEKTRISCHE N SCHLAGES ODER EINER EXPLOSION.</b></p> <ul style="list-style-type: none"> <li>• Stellen Sie jeglichen Strom ab, der dieses Gerät versorgt, bevor Sie an dem Gerät Arbeiten durchführen</li> <li>• Vor dem Drehen auf Energie alle Anschlüsse überprüfen und alle Abdeckungen ersetzen.</li> </ul> <p><b>Unterlassung dieser Anweisungen können zum Tode oder zu schweren Verletzungen führen.</b></p>	<p><b>RISCHIO DI SCOSSA ELETTRICA O DELL'ESPLOSIONE.</b></p> <ul style="list-style-type: none"> <li>• Spenga tutta l'alimentazione che fornisce questa apparecchiatura prima di lavorare a questa apparecchiatura</li> <li>• Verificare tutti i collegamenti e sostituire tutte le coperture prima dell'accensione</li> </ul> <p><b>L'omissione di queste istruzioni provocherà la morte o lesioni serie</b></p>	<p><b>存在电击、爆炸或电弧闪烁危险</b></p> <ul style="list-style-type: none"> <li>• 在操作此设备之前请先关闭电源。</li> </ul> <p><b>若不遵守这些说明，可能会导致严重的人身伤害甚至死亡。</b></p>
--	--	---	--	--	---

**⚠ WARNING / AVERTISSEMENT / WARNUNG /ADVERTENCIA / AVVERTENZA / 警告**

<p><b>RISK OF MATERIAL DAMAGE AND HOT ENCLOSURE</b></p> <ul style="list-style-type: none"> <li>• The product's side panels may be hot, allow the product to cool before touching.</li> <li>• Follow proper mounting instructions including torque values.</li> <li>• Do not allow liquids or foreign objects to enter this product.</li> </ul> <p><b>Failure to follow these instructions can result in serious injury, or equipment damage.</b></p>	<p><b>RISQUE DE DOMMAGE MATERIEL ET DE SURCHAUFFE DU BOITIER</b></p> <ul style="list-style-type: none"> <li>• Les panneaux latéraux du produit peuvent être chauds. Laisser le produit refroidir avant de le toucher.</li> <li>• Respecter les consignes de montage, et notamment les couples de serrage.</li> <li>• Ne pas laisser pénétrer de liquide ni de corps étrangers à l'intérieur du produit.</li> </ul> <p><b>Le non-respect de cette directive peut entraîner, des lésions corporelles graves ou des dommages matériels.</b></p>	<p><b>GEFAHR VON MATERIALSCHÄDEN UND GEHÄUSEERHITZUNG</b></p> <ul style="list-style-type: none"> <li>• Die Seitenwände können heiß sein. Lassen Sie das Produkt abkühlen, bevor Sie es berühren.</li> <li>• Beachten Sie die Montageanweisungen, Führen Sie keine Flüssigkeiten oder Fremdkörper in das Produkt ein.</li> </ul> <p><b>Die Nichtbeachtung dieser Anweisung kann Körperverletzung oder Materialschäden zur Folge haben.</b></p>
<p><b>RIESGO DE DAÑOS MATERIALES Y DE SOBRECALENTAMIENTO DE LA UNIDAD</b></p> <ul style="list-style-type: none"> <li>• Los paneles laterales del producto pueden estar calientes. Esperar que el producto se enfríe antes de tocarlo.</li> <li>• Respetar las instrucciones de montaje, y en particular los pares de apretado.</li> <li>• No dejar que penetren líquidos o cuerpos extraños en el producto.</li> </ul> <p><b>Si no se respetan estas precauciones pueden producirse graves lesiones, daños materiales.</b></p>	<p><b>RISCHIO DI DANNI MATERIALI E D'INVOLUCRO CALDO</b></p> <ul style="list-style-type: none"> <li>• I pannelli laterali dell'apparecchio possono scottare; lasciar quindi raffreddare il prodotto prima di toccarlo.</li> <li>• Seguire le istruzioni di montaggio corrette.</li> <li>• Non far entrare liquidi o oggetti estranei in questo apparecchio.</li> </ul> <p><b>La mancata osservanza di questa precauzione può causare gravi rischi per l'incolumità personale o danni alle apparecchiature.</b></p>	<p><b>材料损坏和高温外壳的危险性</b></p> <ul style="list-style-type: none"> <li>• 产品的一侧面板可能很热，在其冷却前请不要触碰。</li> <li>• 遵照正确的安装说明，包括扭矩值。</li> <li>• 请勿让液体及其他异物进入本产品。</li> </ul> <p><b>如不能正确执行这些操作说明，极有可能造成严重人体伤害或者设备的损坏。</b></p>

**ANNEX - ENVIRONMENTAL INFORMATION**

The environmental information disclosed in this annex including the EIP Pollution logo are in compliance with People’s Republic of China Electronic Industry Standard SJ/T11364 – 2006, Marking for Control of Pollution Caused by Electronic Information Products.

Part Name	Toxic or hazardous Substance and Elements					
	Lead (Pb)	Mercury (Hg)	Cadmium (Cd)	Hexavalent Chromium (Cr (VI))	Polybrominated biphenyls (PBB)	Polybrominated diphenyl ethers (PBDE)
Semiconductor die	X	○	○	○	○	○
Solder	X	○	○	○	○	○

附件 – 环保信息

此附件所标示的包括电子信息产品污染图标的环保信息符合中华人民共和国电子行业标准 SJ/T11364 - 2006, 电子信息产品污染控制标识要求。

部件名称	有毒有害物质或元素					
	铅 (Pb)	汞 (Hg)	镉 (Cd)	六价铬 (Cr (VI))	多溴联苯 (PBB)	多溴二苯醚 (PBDE)
半导体芯片	X	○	○	○	○	○
焊接点	X	○	○	○	○	○

