

# MSA-0786

## Cascadable Silicon Bipolar MMIC Amplifier



### Data Sheet

#### Description

The MSA-0786 is a high performance silicon bipolar Monolithic Microwave Integrated Circuit (MMIC) housed in a low cost, surface mount plastic package. This MMIC is designed for use as a general purpose 50 Ω gain block. Applications include narrow and broad band IF and RF amplifiers in commercial and industrial applications.

The MSA-series is fabricated using Avago's 10 GHz  $f_T$ , 25 GHz  $f_{MAX}$ , silicon bipolar MMIC process which uses nitride self-alignment, ion implantation, and gold metalization to achieve excellent performance, uniformity and reliability. The use of an external bias resistor for temperature and current stability also allows bias flexibility.

#### Features

- Cascadable 50 Ω Gain Block
- Low Operating Voltage: 4.0 V Typical  $V_d$
- 3 dB Bandwidth: DC to 2.0 GHz
- 12.5 dB Typical at 1.0 GHz
- Unconditionally Stable ( $k > 1$ )
- Surface Mount Plastic Package
- Tape-and-Reel Packaging Available
- Lead-free Option Available

#### 86 Plastic Package

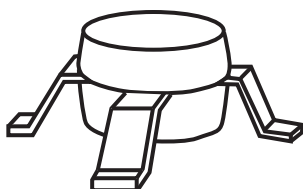

#### Typical Biasing Configuration

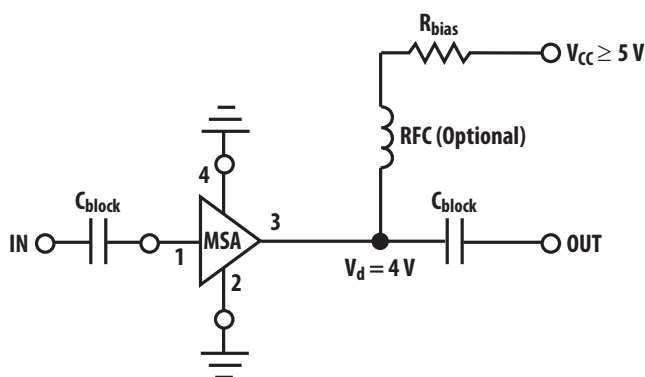

## MSA-0786 Absolute Maximum Ratings

Parameter	Absolute Maximum <sup>[1]</sup>
Device Current	60 mA
Power Dissipation <sup>[2, 3]</sup>	275 mW
RF Input Power	+13 dBm
Junction Temperature	150° C
Storage Temperature	-65 to 150° C

### Thermal Resistance <sup>[2]</sup>:

$$\theta_{jc} = 120^{\circ}\text{C/W}$$

Notes:

1. Permanent damage may occur if any of these limits are exceeded.
2.  $T_{\text{CASE}} = 25^{\circ}\text{C}$ .
3. Derate at 8.3 mW/°C for  $T_C > 117^{\circ}\text{C}$ .

## Electrical Specifications<sup>[1]</sup>, $T_A = 25^{\circ}\text{C}$

Symbol	Parameters and Test Conditions: $I_d = 16\text{ mA}$ , $Z_0 = 50\ \Omega$	Units	Min.	Typ.	Max.
$G_p$	Power Gain ( $ S_{21} ^2$ ) f = 0.1 GHz f = 1.0 GHz	dB	10.5	13.5 12.5	
$\Delta G_p$	Gain Flatness f = 0.1 to 1.3 GHz	dB		+0.7	
$f_{3\text{ dB}}$	3 dB Bandwidth <sup>[2]</sup>	GHz		2.0	
VSWR	Input VSWR f = 0.1 to 2.5 GHz			1.7:1	
	Output VSWR f = 0.1 to 2.5 GHz			1.7:1	
NF	50 $\Omega$ Noise Figure f = 1.0 GHz	dB		5.0	
$P_{1\text{ dB}}$	Output Power at 1 dB Gain Compression f = 1.0 GHz	dBm		5.5	
$IP_3$	Third Order Intercept Point f = 1.0 GHz	dBm		19.0	
$t_D$	Group Delay f = 1.0 GHz	psec		150	
$V_d$	Device Voltage	V	3.2	4.0	4.8
$dV/dT$	Device Voltage Temperature Coefficient	mV/°C		-7.0	

Notes:

1. The recommended operating current range for this device is 15 to 40 mA. Typical performance as a function of current is on the following page.

## Ordering Information

Part Numbers	No. of Devices	Comments
MSA-0786-BLK	100	Bulk
MSA-0786-BLKG	100	Bulk
MSA-0786-TR1	1000	7" Reel
MSA-0786-TR1G	1000	7" Reel

Note: Order part number with a "G" suffix if lead-free option is desired.

**MSA-0786 Typical Scattering Parameters ( $Z_0 = 50 \Omega$ ,  $T_A = 25^\circ \text{C}$ ,  $I_d = 22 \text{ mA}$ )**

Freq. GHz	$S_{11}$		$S_{21}$		$S_{12}$		$S_{22}$			
	Mag	Ang	dB	Mag	Ang	dB	Mag	Ang	Mag	Ang
0.1	0.05	175	13.5	4.74	174	-18.7	0.116	1	0.14	-12
0.2	0.05	174	13.4	4.71	169	-18.7	0.117	3	0.14	-22
0.4	0.04	167	13.3	4.64	158	-18.4	0.120	7	0.15	-44
0.6	0.04	175	13.1	4.52	148	-18.3	0.122	7	0.16	-65
0.8	0.05	-156	12.9	4.39	138	-18.0	0.126	8	0.17	-84
1.0	0.06	-134	12.6	4.25	127	-17.5	0.134	10	0.18	-102
1.5	0.08	-142	11.6	3.79	103	-16.6	0.148	9	0.21	-139
2.0	0.15	-159	10.5	3.34	80	-15.7	0.164	7	0.23	-164
2.5	0.25	-176	9.2	2.89	63	-15.1	0.176	5	0.24	174
3.0	0.33	166	7.8	2.45	44	-14.7	0.185	1	0.24	159
3.5	0.41	150	6.5	2.11	27	-14.9	0.179	-5	0.24	149
4.0	0.49	137	5.2	1.82	12	-15.1	0.177	-9	0.23	145
5.0	0.60	116	3.0	1.41	-14	-15.4	0.169	-14	0.26	145

## Typical Performance, $T_A = 25^\circ\text{C}$

(unless otherwise noted)

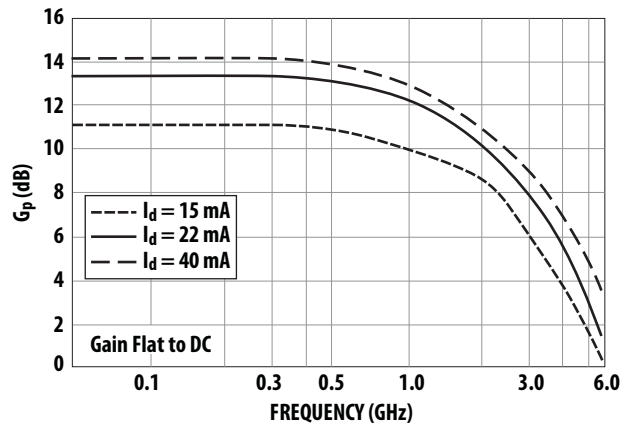

Figure 1. Typical Power Gain vs Frequency.

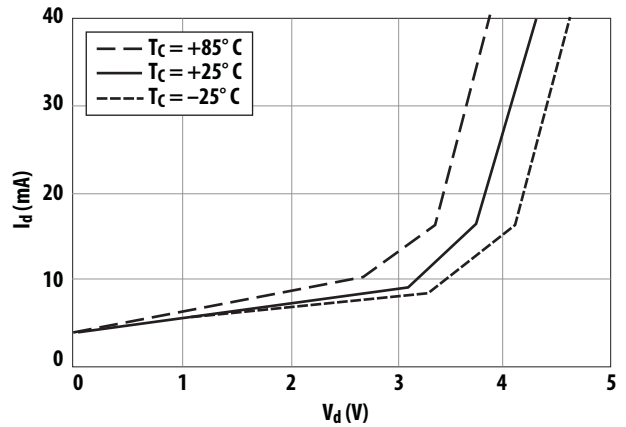

Figure 2. Device Current vs. Voltage.

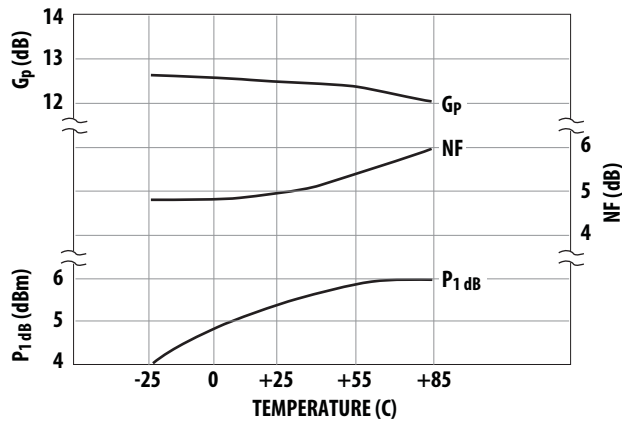

Figure 3. Output Power at 1 dB Gain Compression, NF and Power Gain vs. Case Temperature,  $f = 1.0\text{ GHz}$ ,  $I_d = 22\text{ mA}$ .

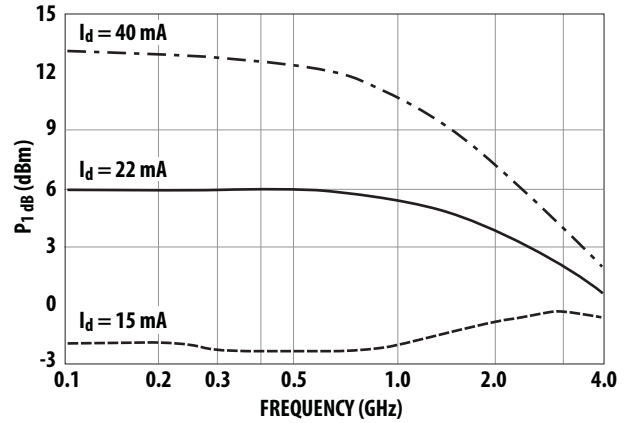

Figure 4. Output Power at 1 dB Gain Compression vs. Frequency.

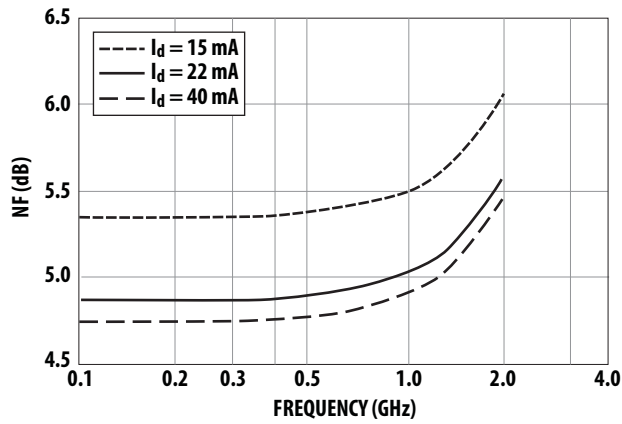
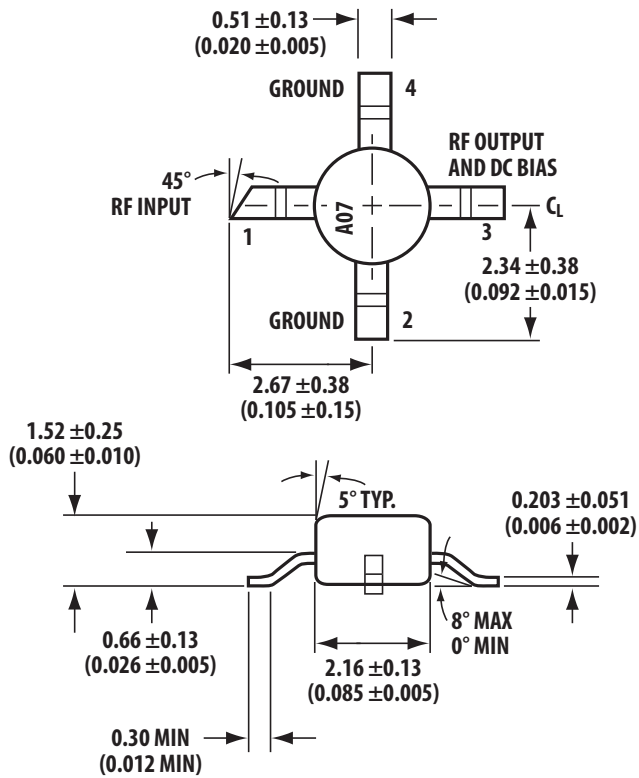

Figure 5. Noise Figure vs. Frequency.

## 86 Plastic Package Dimensions



Dimensions are in millimeters (inches)

For product information and a complete list of distributors, please go to our web site: [www.avagotech.com](http://www.avagotech.com)

Avago, Avago Technologies, and the A logo are trademarks of Avago Technologies in the United States and other countries. Data subject to change. Copyright © 2005-2012 Avago Technologies. All rights reserved. Obsoletes 5989-2769EN AV02-3635EN - June 19, 2012

**AVAGO**  
TECHNOLOGIES