

**Digital Attenuator, 1 Bit, 10 dB Step  
DC - 2.0 GHz**

**AT-266  
V4**

**Features**

- Single 10 dB Step
- Low Loss: 0.3 dB @ 900 MHz
- Low Cost SOT-25 Package

**Description**

M/A-COM's AT-266 is a 1 bit, 10 dB step GaAs MMIC digital attenuator in a low cost SOT-25 surface mount plastic package. The AT-266 is ideally suited for use where high accuracy, very low power consumption and low intermodulation products are required. Typical applications include radio, wireless LANs, GPS equipment and other gain/level control circuits.

The AT-266 is fabricated using a mature GaAs MMIC process featuring full chip passivation for increased performance and reliability.

**Ordering Information**

Part Number	Package
AT-266	Bulk Packaging
AT-266TR	1000 piece reel

Note: Reference Application Note M513 for reel size information.

**Absolute Maximum Ratings** <sup>1,2</sup>

Parameter	Absolute Maximum
Input Power 50 MHz 500 - 2000 MHz	+27 dBm +34 dBm
Control Voltage	-8.5 V ≤ Vc ≤ +8 V
Operating Temperature	-40°C to +85°C
Storing Temperature	-65°C to +150°C

1. Exceeding any one or combination of these limits may cause permanent damage to this device.
2. M/A-COM does not recommend sustained operation near these survivability limits.

**Functional Block Diagram**

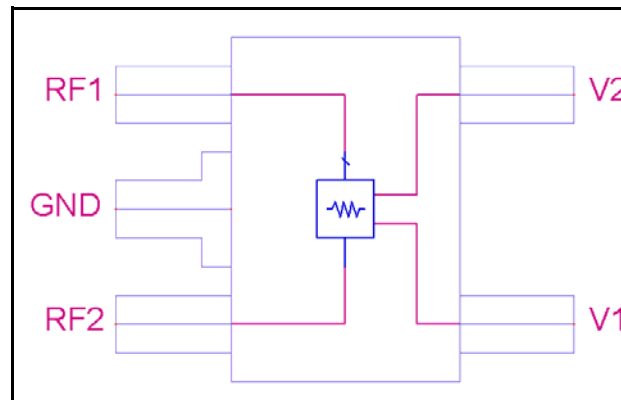

**Pin Configuration**

Pin No.	Function	Description
1	RF1	RF In/Out
2	GND	RF Ground
3	RF2	RF In/Out
4	V1	Control Voltage
5	V2	Control Voltage

**Truth Table** <sup>3,4,5</sup>

V1	V2	Attenuation State
0	1	10 dB
1	0	Insertion Loss

3. For positive voltage control, external DC blocking capacitors are required on all RF ports (pins 1, 2 and 3).
4. Differential voltage, V(state 1) - V(state 0), must be +2.8 V minimum and less than 8 V.
5. 0 = -8 V to 0.2 V, 1 = -0.2 V to 8 V

**Digital Attenuator, 1 Bit, 10 dB Step  
DC - 2.0 GHz**

**AT-266  
V4**

**Electrical Specifications:  $T_A = 25^\circ\text{C}$ ,  $V_C = 0\text{ V} / -3\text{ V}$ ,  $Z_0 = 50\ \Omega$**

Parameter	Test Conditions	Units	Min.	Typ.	Max.
Insertion Loss	0 - 1 GHz	dB	—	0.3	0.45
	1 - 2 GHz	dB	—	0.5	0.7
Attenuation	DC - 1 GHz	dB	9.6	10	10.4
	1 - 2 GHz	dB	9.5	10	10.5
VSWR	0 - 2 GHz	Ratio	—	1.4:1	1.5:1
$IP_3$	2 Tone @ 0 dBm, 5 MHz spacing	dBm	42	50	—
P1dB	1 GHz	dBm	23	28	—
Trise, Tfall	10% to 90% RF, 90% to 10% RF	nS	—	5	20
Ton, Toff	50% Control to 90% RF, 50% Control to 10% RF	nS	—	10	25
Transients	In Band	mV	—	6	10
Control Current	$ V_C  = 3\text{ V}$	$\mu\text{A}$	—	25	—

**SOT-25 Plastic Package**

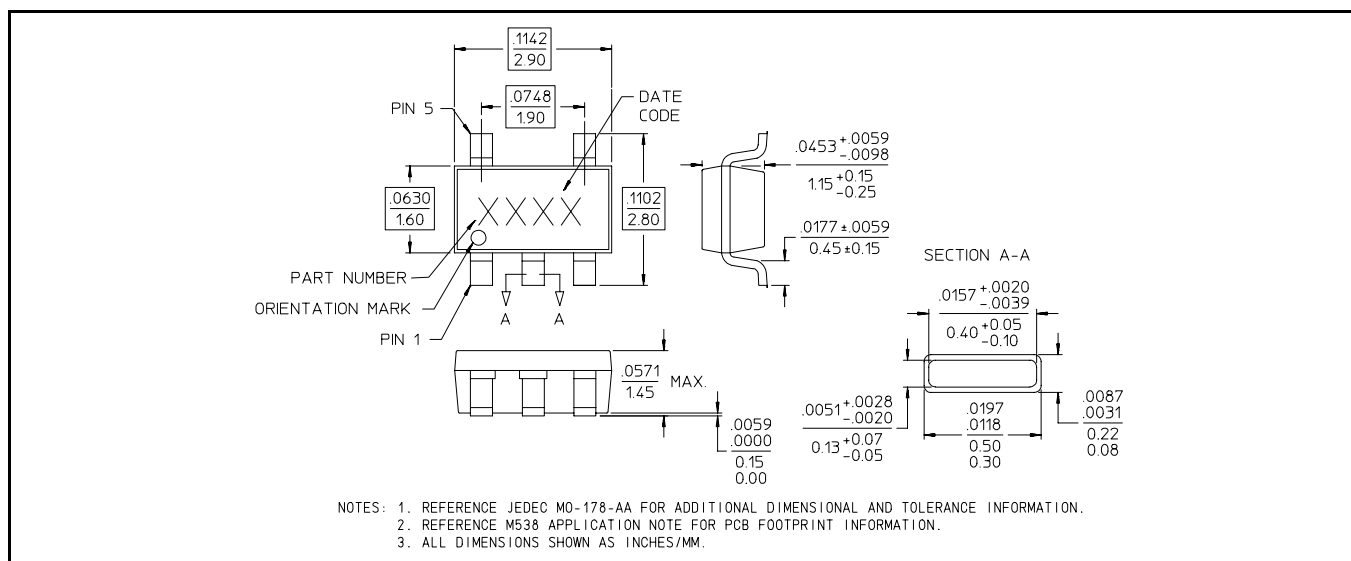

**Handling Procedures**

Please observe the following precautions to avoid damage:

**Static Sensitivity**

Gallium Arsenide Integrated Circuits are sensitive to electrostatic discharge (ESD) and can be damaged by static electricity. Proper ESD control techniques should be used when handling these devices.

**Digital Attenuator, 1 Bit, 10 dB Step  
DC - 2.0 GHz**

**AT-266  
V4**

**Typical Performance Curves (39 pF capacitors used for positive voltage control)**

*Insertion Loss (Positive Control)*

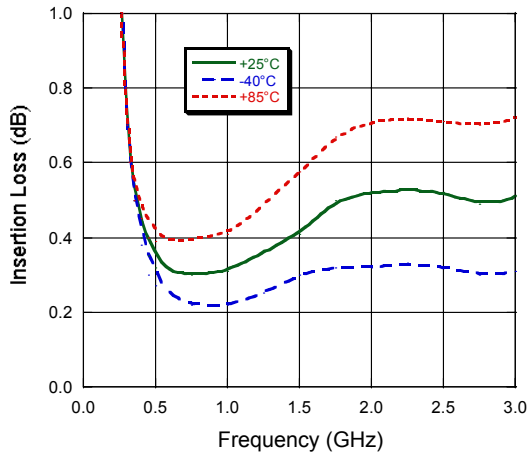

*Insertion Loss (Negative Control)*

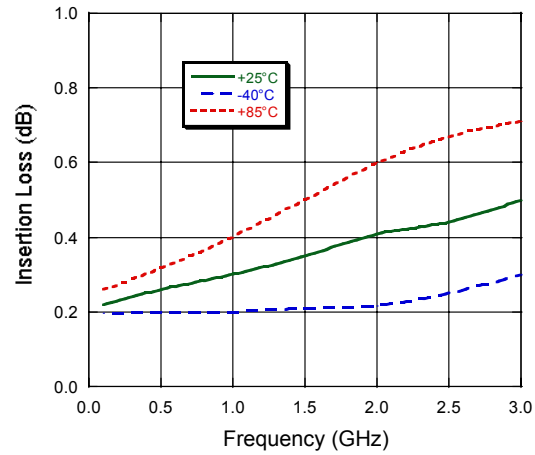

*Relative Attenuation (Positive Control)*

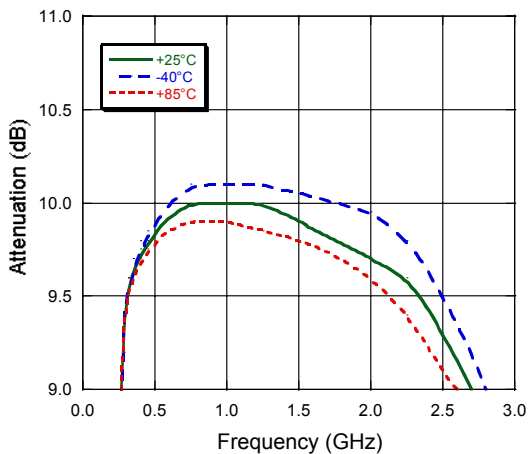

*Relative Attenuation (Negative Control)*

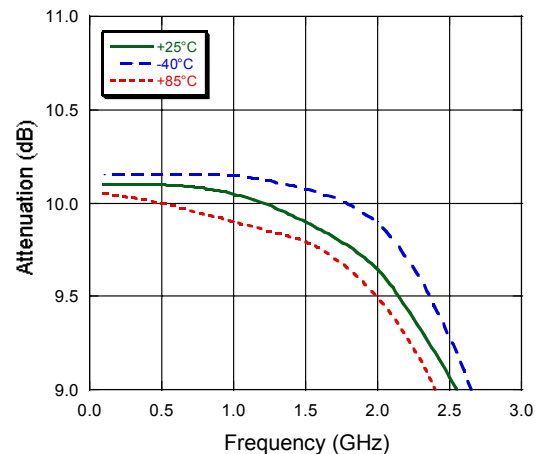

*Return Loss (Reference State)*

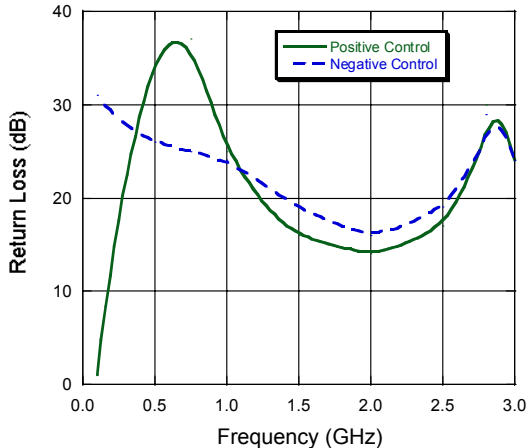

*Return Loss (10 dB State)*

