

Coaxial Amplifier

ZFL-2000+

50Ω Medium Power 10 to 2000 MHz

Features

- wideband, 10 to 2000 MHz
- high gain, 20 dB min.
- unconditionally stable
- protected by US Patent, 6,943,629

Applications

- instrumentation
- communication
- lab use

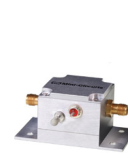

ZFL-2000X+

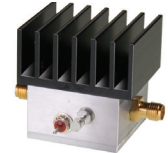

ZFL-2000+

CASE STYLE: SS98

Connectors	Model
SMA	ZFL-2000+
BRACKET (OPTION "B")	
SMA	ZFL-2000X+

+RoHS Compliant

The +Suffix identifies RoHS Compliance. See our web site for RoHS Compliance methodologies and qualifications

Amplifier Electrical Specifications

MODEL NO.	FREQUENCY (MHz)		GAIN (dB)		MAXIMUM POWER (dBm)		DYNAMIC RANGE		VSWR (:1) Typ.		DC POWER	
	f_L	f_U	Min.	Flatness Max.	Output ¹ (1 dB Compr.)	Input (no damage)	NF (dB) Typ.	IP3 (dBm) Typ.	In	Out	Volt (V) Nom.	Current (mA) Max.
ZFL-2000+	10	2000	20	±1.5	+16	+5	7.0	+25	2.0	2.0	15	120
ZFL-2000X+	10	2000	20	±1.5	+16	+5	7.0	+25	2.0	2.0	15	120

* Heat sink not included

¹+15 dBm below 1000 MHz.

Open load is not recommended, potentially can cause damage. With no load derate max input power by 20 dB

To order without heat sink, add suffix X to model number. Alternative heat sinking and heat removal must be provided by the user to limit maximum temperature to 71°C, in order to ensure proper performance. For reference, this requires thermal resistance of user's external heat sink to be 15°C/W Max.

Maximum Ratings

Operating Temperature -20°C to 71°C

Storage Temperature -55°C to 100°C

DC Voltage +17V Max.

Permanent damage may occur if any of these limits are exceeded.

Outline Drawing

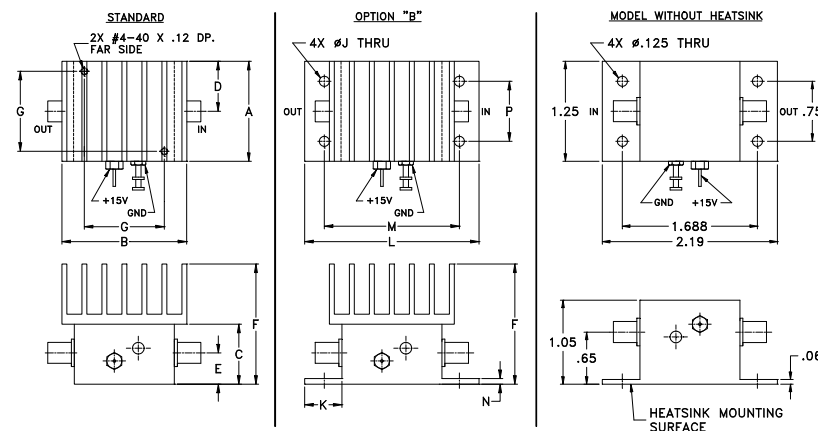

Outline Dimensions (inch/mm)

A	B	C	D	E	F	G	H	J	K	L	M	N	P	wt*
1.25	1.56	.75	.63	.39	1.50	1.000	--	.125	.46	2.19	1.688	.06	.750	grams
31.75	39.62	19.05	16.00	9.91	38.10	25.40	--	3.18	11.68	55.63	42.88	1.52	19.05	85.0

*70 grams without heat sink

Notes

- Performance and quality attributes and conditions not expressly stated in this specification document are intended to be excluded and do not form a part of this specification document.
- Electrical specifications and performance data contained in this specification document are based on Mini-Circuit's applicable established test performance criteria and measurement instructions.
- The parts covered by this specification document are subject to Mini-Circuits standard limited warranty and terms and conditions (collectively, "Standard Terms"); Purchasers of this part are entitled to the rights and benefits contained therein. For a full statement of the Standard Terms and the exclusive rights and remedies thereunder, please visit Mini-Circuits' website at www.minicircuits.com/MCLStore/terms.jsp



FREQUENCY (MHz)	GAIN (dB)			DIRECTIVITY (dB)			VSWR (:1)		NOISE FIGURE (dB)	POUT at 1 dB COMPR. (dBm)
	12V	15V	16V	12V	15V	16V	IN	OUT		
10.00	20.67	21.23	21.35	17.50	16.70	16.80	1.65	1.78	5.52	15.80
19.10	20.87	21.42	21.53	16.80	16.40	16.60	1.62	1.44	5.24	16.11
50.50	20.82	21.38	21.49	17.10	16.80	16.60	1.62	1.30	4.28	15.83
133.40	20.79	21.34	21.45	17.00	16.50	16.20	1.60	1.30	3.96	15.95
352.30	20.77	21.30	21.41	16.10	15.80	15.80	1.56	1.33	4.14	16.30
724.40	21.03	21.53	21.64	14.50	13.90	13.90	1.43	1.35	4.23	16.76
877.40	21.07	21.56	21.65	13.80	13.30	13.00	1.37	1.27	4.28	16.72
1030.50	20.97	21.46	21.55	13.00	12.60	12.60	1.31	1.19	4.39	16.69
1132.60	20.85	21.37	21.47	12.90	12.30	12.30	1.29	1.16	4.44	16.60
1234.60	20.76	21.27	21.37	12.50	12.40	12.40	1.30	1.21	4.49	16.73
1387.70	20.56	21.06	21.14	12.20	11.90	12.10	1.43	1.36	4.59	16.74
1540.80	20.50	20.96	21.02	11.60	11.60	11.50	1.63	1.54	4.78	16.74
1693.80	20.68	21.11	21.17	10.20	10.50	10.50	1.79	1.61	4.90	16.99
1846.90	20.87	21.32	21.40	8.60	9.10	9.10	1.77	1.43	4.99	16.99
2000.00	20.86	21.38	21.47	7.50	7.80	8.10	1.47	1.07	5.30	16.80

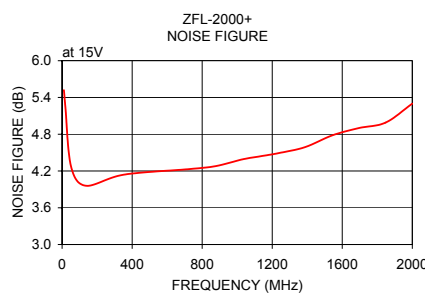
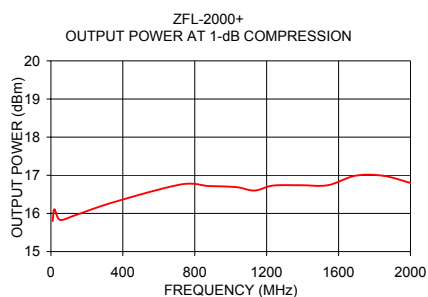
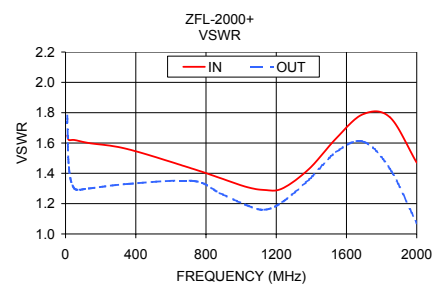
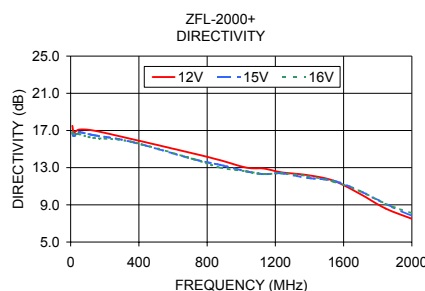
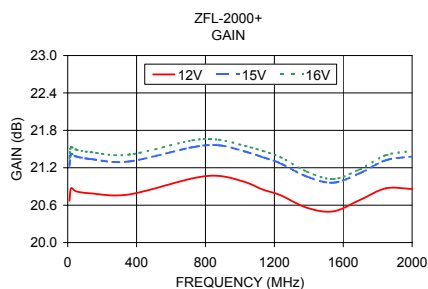

Notes

- A. Performance and quality attributes and conditions not expressly stated in this specification document are intended to be excluded and do not form a part of this specification document.
- B. Electrical specifications and performance data contained in this specification document are based on Mini-Circuit's applicable established test performance criteria and measurement instructions.
- C. The parts covered by this specification document are subject to Mini-Circuits standard limited warranty and terms and conditions (collectively, "Standard Terms"); Purchasers of this part are entitled to the rights and benefits contained therein. For a full statement of the Standard Terms and the exclusive rights and remedies thereunder, please visit Mini-Circuits' website at www.minicircuits.com/MCLStore/terms.jsp

