



SS12F SERIES

SURFACE MOUNT SCHOTTKY BARRIER RECTIFIER

VOLTAGE 20-60 Volt **CURRENT** 1 Ampere

SMAF Unit : inch(mm)

FEATURES

- For surface mounted applications in order to optimize board space
- Ultra Thin Profile Package for Space Constrained Utilization
- Package suitable for Automated Handling
- Low power loss, high efficiency
- High surge capacity
- High current capacity , low V_F
- Plastic package has Underwriters Laboratory Flammability Classification 94V-O
- Lead free in compliance with EU RoHS 2011/65/EU directive.
- Green molding compound as per IEC61249 Std. . (Halogen Free)

MECHANICAL DATA

- Case: Plastic molded
- Terminals: Solder plated, solderable per MIL-STD-750, Method 2026
- Polarity: Color band denotes cathode end
- Approx. Weight: 0.0011 ounces, 0.0328 grams

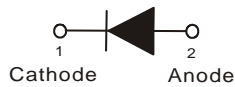
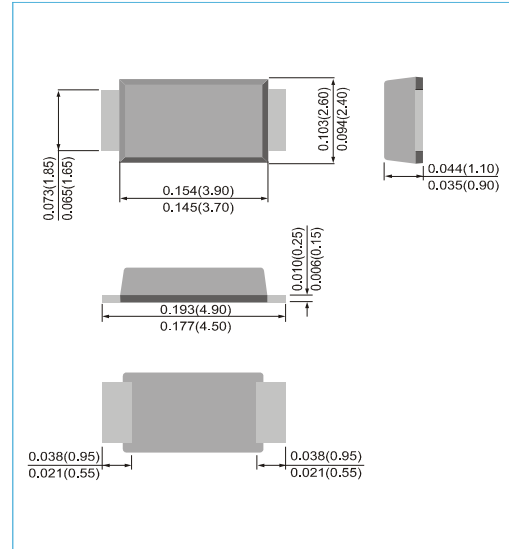

MAXIMUM RATINGS AND ELECTRICAL CHARACTERISTICS ($T_A=25^{\circ}\text{C}$ unless otherwise noted)

PARAMETER	SYMBOL	SS12F	SS13F	SS14F	SS15F	SS16F	UNITS
Recurrent Peak Reverse Voltage	V_{RRM}	20	30	40	50	60	V
RMS Voltage	V_{RMS}	14	21	28	35	42	V
DC Blocking Voltage	V_R	20	30	40	50	60	V
Average Forward Current	$I_{F(AV)}$	1					A
Peak Forward Surge Current : 8.3ms single half sine-wave superimposed on rated load	I_{FSM}	30					A
Forward Voltage at 1A	V_F	0.5		0.7		V	
DC Reverse Current at Rated DC Blocking Voltage $T_J=25^{\circ}\text{C}$	I_R	0.2		0.1		mA	
Maximum DC Reverse Current at Rated DC Blocking Voltage $T_J=100^{\circ}\text{C}$	I_R	5					mA
Typical Junction capacitance $V_R=4\text{V}, f=1\text{MHz}$	C_J	45					pF
Typical Thermal Resistance ,Junction to Lead (Note 1) Junction to Ambient (Note 2)	$R_{\theta JL}$ $R_{\theta JA}$	18 150					$^{\circ}\text{C} / \text{W}$
Operating Junction Temperature and Storage Temperature Range	T_J, T_{STG}	-55 to +150					$^{\circ}\text{C}$

NOTES : 1. Mounted on a FR4 PCB, single-sided copper, with 48cm^2 copper pad area
2. Mounted on a FR4 PCB, single-sided copper, mini pad.



SS12F SERIES

RATING AND CHARACTERISTIC CURVES

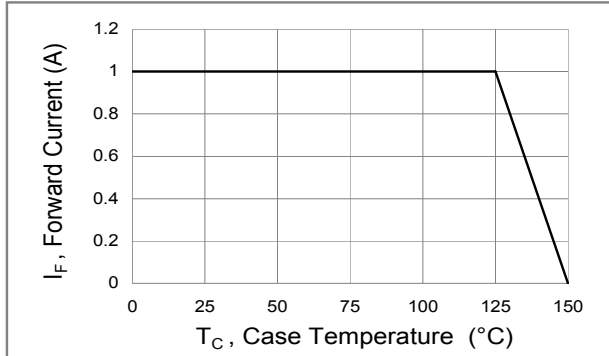

Fig.1 Forward Current Derating Curve

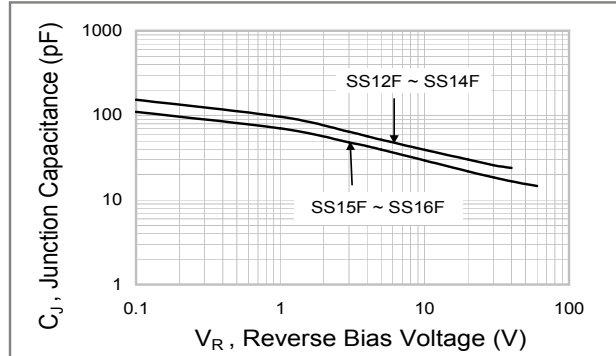

Fig.2 Typical Junction Capacitance

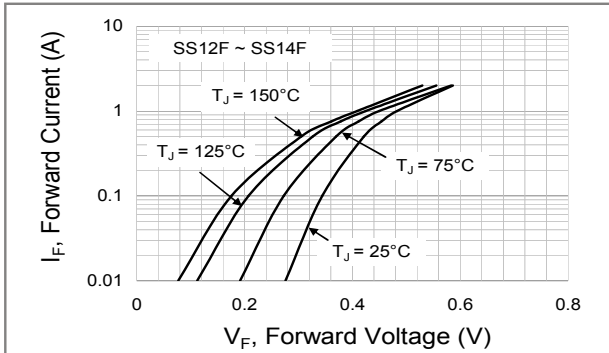

Fig.3 Typical Forward Characteristics

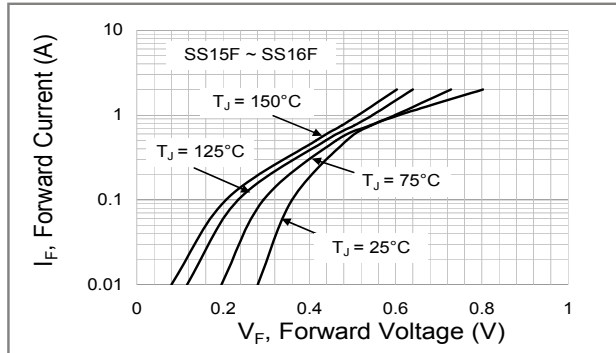

Fig.4 Typical Forward Characteristics

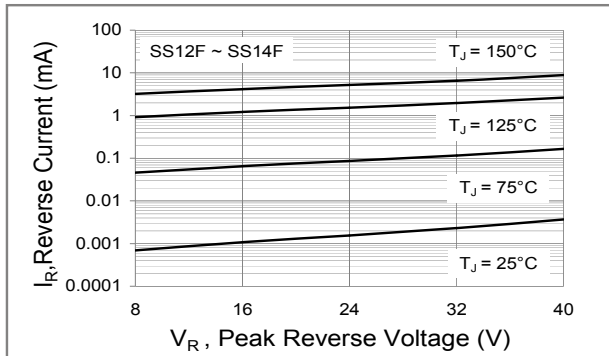

Fig.5 Typical Reverse Characteristics

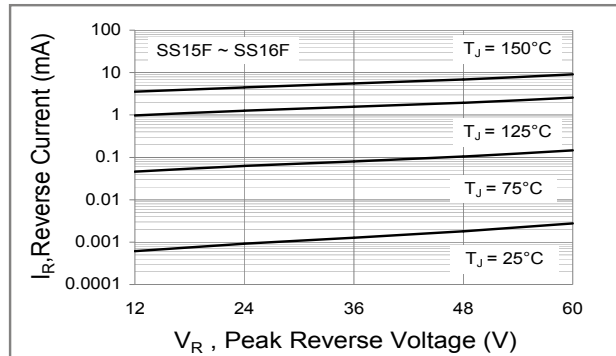

Fig.6 Typical Reverse Characteristics

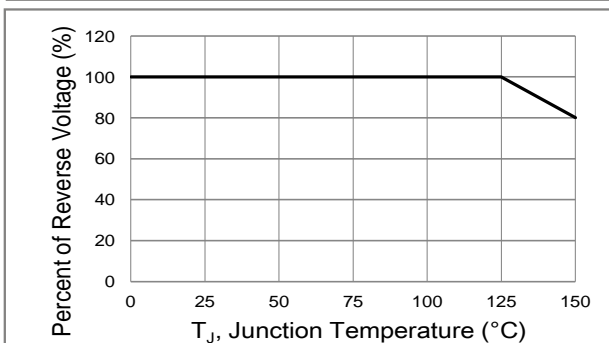
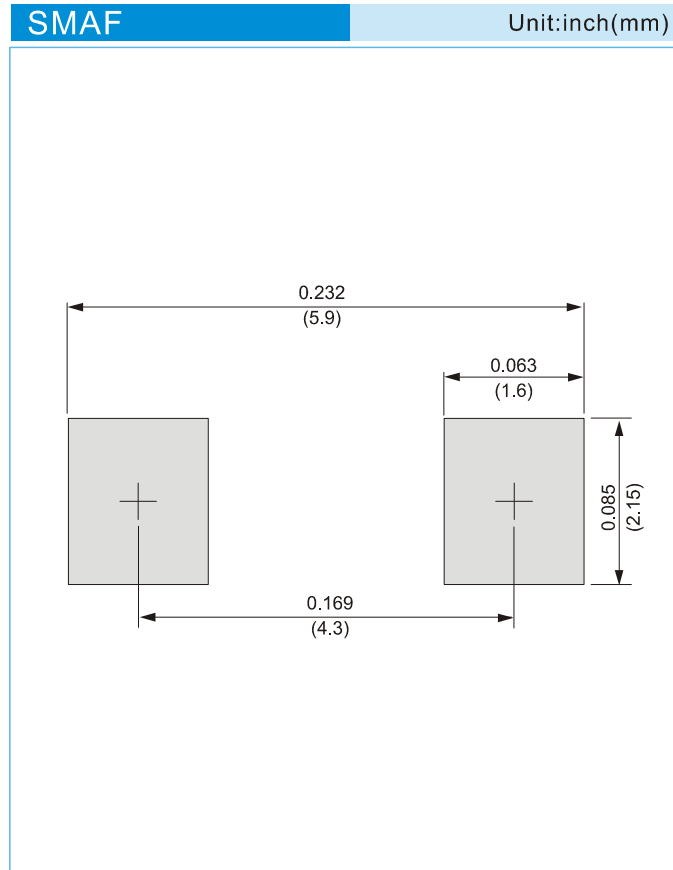

Fig.7 Operating Temperature Derating Curve



SS12F SERIES

MOUNTING PAD LAYOUT



ORDER INFORMATION

- Packing information
T/R - 10K per 13" plastic Reel
T/R - 3K per 7" plastic Reel



SS12F SERIES

Part No_packing code_Version

SS12F_R1_00001

SS12F_R2_00001

For example :

RB500V-40_R2_00001



Packing Code XX				Version Code XXXXX		
Packing type	1 st Code	Packing size code	2 nd Code	HF or RoHS	1 st Code	2 nd ~5 th Code
Tape and Ammunition Box (T/B)	A	N/A	0	HF	0	serial number
Tape and Reel (T/R)	R	7"	1	RoHS	1	serial number
Bulk Packing (B/P)	B	13"	2			
Tube Packing (T/P)	T	26mm	X			
Tape and Reel (Right Oriented) (TRR)	S	52mm	Y			
Tape and Reel (Left Oriented) (TRL)	L	PANASERT T/B CATHODE UP (PBCU)	U			
FORMING	F	PANASERT T/B CATHODE DOWN (PBCD)	D			



SS12F SERIES

Disclaimer

- Reproducing and modifying information of the document is prohibited without permission from Panjit International Inc..
- Panjit International Inc. reserves the rights to make changes of the content herein the document anytime without notification. Please refer to our website for the latest document.
- Panjit International Inc. disclaims any and all liability arising out of the application or use of any product including damages incidentally and consequentially occurred.
- Panjit International Inc. does not assume any and all implied warranties, including warranties of fitness for particular purpose, non-infringement and merchantability.
- Applications shown on the herein document are examples of standard use and operation. Customers are responsible in comprehending the suitable use in particular applications. Panjit International Inc. makes no representation or warranty that such applications will be suitable for the specified use without further testing or modification.
- The products shown herein are not designed and authorized for equipments requiring high level of reliability or relating to human life and for any applications concerning life-saving or life-sustaining, such as medical instruments, transportation equipment, aerospace machinery et cetera. Customers using or selling these products for use in such applications do so at their own risk and agree to fully indemnify Panjit International Inc. for any damages resulting from such improper use or sale.
- Since Panjit uses lot number as the tracking base, please provide the lot number for tracking when complaining.