

CONNECT AND PROTECT

MultipacPRO

09/2021

nvent

SCHROFF

19" chassis – MultipacPRO

OVERVIEW

MAIN KATALOG

- Cabinets 1
- Wall mounted cases 2
- Accessories for cabinets and wall mounted cases .. 3
- Climate control .. 4
- Electronics cases 5
- Subracks/ 19" chassis 6
- Front panels, plug-in units 7
- Systems 8
- Power supply units 9
- Backplanes 10
- Connectors, front panel component system 11
- Appendix 12

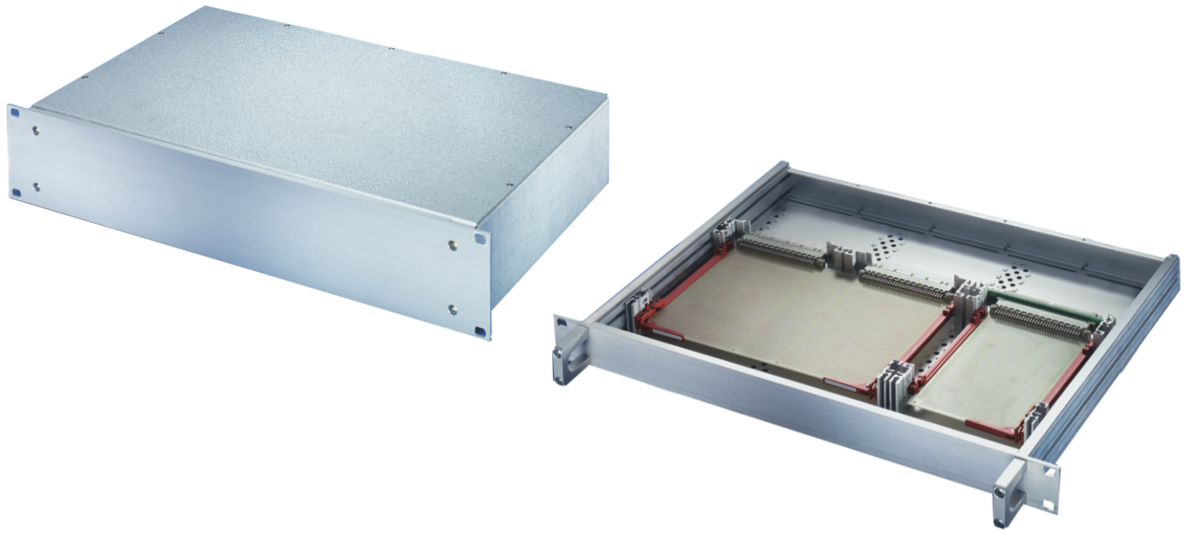

06005001

STANDARDS/CERTIFICATIONS

- Exterior dimensions in accordance with: IEC 60297-3-100, 101, 105
- Ingress protection IP 20 in accordance with IEC 60529
- EMC testing in accordance with VG 95373 part 15 or IEC 61587



06008009

Handles can be bolted on from front

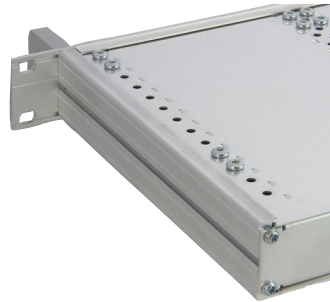

06008010

High stability with aluminium profile side panel

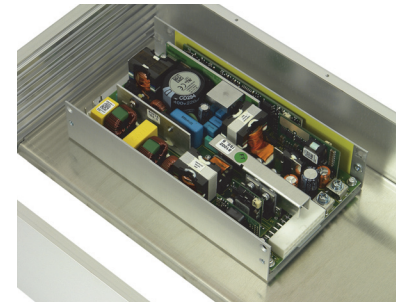

06008011

Mounting plate for fitting heavy components

Top cover and base plate in 3 versions



06008003

Plain



06008005

Perforated



06008004

For standardised board mounting

19" chassis – MultipacPRO

OVERVIEW

THE IDEAL SOLUTION FOR ELECTRONIC DEVICES IN THE MOST COMPACT DIMENSIONS

- Aluminium or steel (AlZn coated) designs
- For standardised 19" board mounting or for installation of non-standardised components
- EMC shielding upgradable
- Mounting service and customized machining with ServicePLUS



06008005

19" COMPLETE CHASSIS

- 2 materials
 - Steel plate (AlZn coated)
 - Aluminium
- 3 top cover versions
 - Top cover/base plate, solid
 - Top cover/base plate, perforated (aluminium version)
 - Top cover/base plate for standardised PCBs (aluminium version)



06008001

19" CHASSIS, INDIVIDUALLY CONFIGURED FROM SEPARATE PARTS

- For non-standardised assemblies with mounting plate
- For standardised board assembly
- Customised solutions

Overview 6.112

19" complete chassis (St) 6.114

19" complete chassis (Al) 6.115

19" chassis for non-standardised assembly 6.120

19" chassis for standardised assembly 6.122

Accessories

Guide rails 6.124

Telescopic slides
1 U 6.125

Telescopic slides
2 U 6.126

Application examples 6.127

SERVICEPLUS

- e.g. individual configuration and assembly
- e.g. modification (cut-outs)
- e.g. downloads (CAD drawings, user manuals, test reports)
- e.g. custom solutions (special sizes)

19" chassis – MultipacPRO

19" COMPLETE CHASSIS FROM STEEL WITH PLAIN TOP COVER AND BASE PLATE

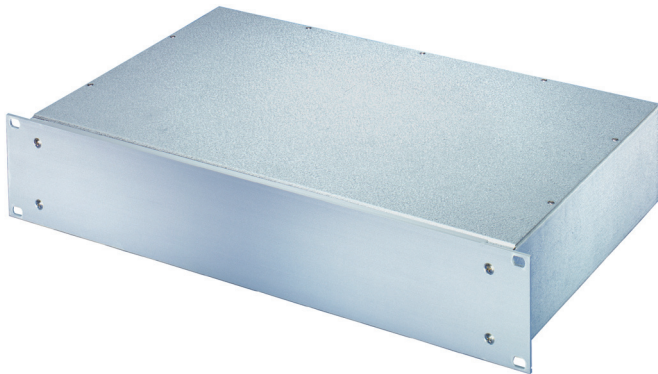

06002003

- Complete chassis, St (AlZn coated) with Al extrusion front panel
- Detachable rear panel for easy machining
- EMV shielding approx. 20 dB(A) at 1 GHz without additional shielding; > 40 dB(A) at 1 GHz with optional EMC gasketing
- In accordance with standard IEC 60297-3-101
- In the 1 U version 19" and ATX power supplies can be assembled up to a clearance of 40 mm

DELIVERY COMPRISES (Kit)

Item	Qty	Description
1	1	Front panel, Al extrusion, 3 mm; in 1 U: front anodised, rear etched; from 2 U: front and rear side of front panels clear passivated
2	1	Base body, plain, St, 1 mm, (AlZn coated)
3	1	Rear panel, St, 1 mm (AlZn coated)
4	1	Cover, plain, St, 1 mm (AlZn coated)
5	1	Assembly kit

ORDER INFORMATION

Height U	Height H mm	Depth T mm	Part no.
1	43.7	220	20860-120
1	43.7	280	20860-121
1	43.7	340	20860-122
2	88.1	280	20860-126
2	88.1	340	20860-127

Accessories

Front handles incl. assembly kit for 1 U, Al extrusion, anodised, PU 2 pieces	20860-256
Front handles incl. assembly kit for 2 U, Al extrusion, anodised, PU 2 pieces	20860-257
EMC sealing to close the gap at the front between case and front panel, 2 saw tooth gaskets, stainless steel, PU 1 piece	20860-132
Assembly tool, Screw driver Torx20 for M4 screws	64560-027

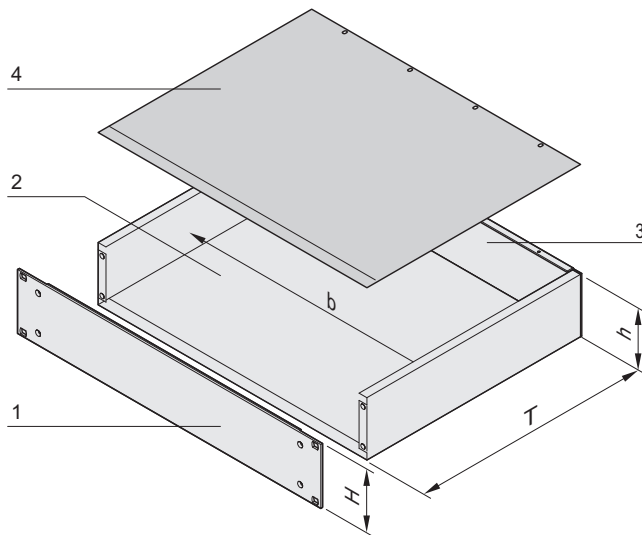

06002051

h = clear height (overall) (H - 3.0 mm)
width = 447 mm

b = clear installation

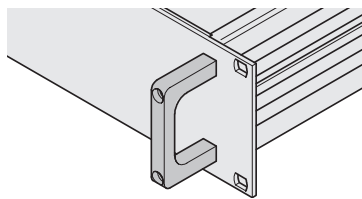

06002052

Front handle

NOTE

- Further versions with steel front panel (pizza box) available on request
- Telescopic slides cannot be used
- No special EMC version available
- Standardised internal mounting kits cannot be used

19" chassis – MultipacPRO

19" COMPLETE CHASSIS FROM ALUMINIUM WITH PLAIN TOP COVER AND BASE PLATE



- Complete chassis from aluminium
- Detachable rear panel for easy machining
- EMC shielding of approx. 30 dB(A) at 1 GHz (without additional shielding material)
- In accordance with standard IEC 60297-3-100, -101, -105
- In the 1 U version 19" and ATX power supplies can be assembled up to a clearance of 35 mm

DELIVERY COMPRISES (Kit)

Item	Qty	Description
1	1	Front panel, Al extrusion, 3 mm; in 1 U: front anodised, rear etched; from 2 U: front and rear side of front panels clear passivated
2	1	Rear panel, Al, 2 mm, etched
3	1	Base plate, plain, Al, 1 mm
4	1	Cover plate, plain, Al, 1 mm
5	2	Side panel, Al extrusion, raw; with grooves for threaded insert (2 x 7); 5 U, two-piece, 3+2 U
6	1	Assembly kit

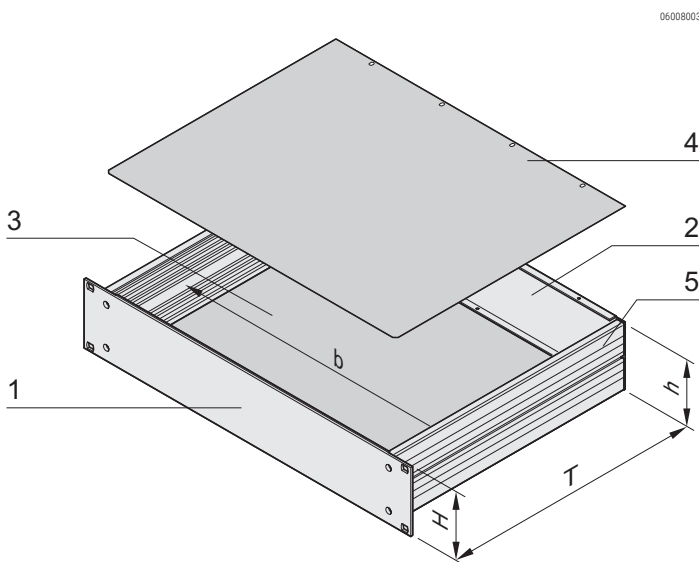

h = clear height (overall) (H - 8.1 mm)
width = 403 mm

b = clear installation

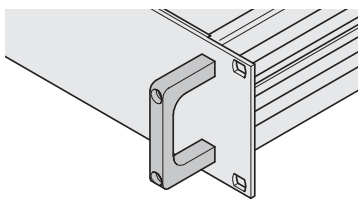

Front handle

ORDER INFORMATION

Height U	Height H mm	Depth T mm	Part no. Kit
1	43.7	220	20860-601
1	43.7	280	20860-602
1	43.7	340	20860-603
2	88.1	220	20860-604
2	88.1	280	20860-605
2	88.1	340	20860-606
3	132.6	280	20860-607
3	132.6	340	20860-608
3	132.6	400	20860-609
3	132.6	460	20860-610
4	177.0	280	20860-611
4	177.0	340	20860-612
4	177.0	400	20860-613
4	177.0	460	20860-614
5	221.5	460	20860-615
EMC gasketing kit Silicone/nickel gasket 2100 mm for contacting side panel/cover plate; seal, stainless steel, for front panel/cover plate, 1 kit			20860-130
Front handles incl. assembly kit for 1 U, Al extrusion, anodised, PU 2 pieces			20860-256
Front handles incl. assembly kit for 2 U, Al extrusion, anodised, PU 2 pieces			20860-257
Front handles incl. assembly kit for 3 U, Al extrusion, anodised, PU 2 pieces			20860-258
Front handles incl. assembly kit for 4 U, Al extrusion, anodised, PU 2 pieces			20860-259
Front handles incl. assembly kit for 5 U, Al extrusion, anodised, PU 2 pieces			20860-260
Assembly tool, Screw driver Torx20 for M4 screws			64560-027

NOTE

- Threaded inserts to push into the side panel see page 6.121
- Telescopic slides to mount into cabinet see page 6.125

19" chassis – MultipacPRO

19" COMPLETE CHASSIS FROM ALUMINIUM WITH PERFORATED TOP COVER AND BASE PLATE

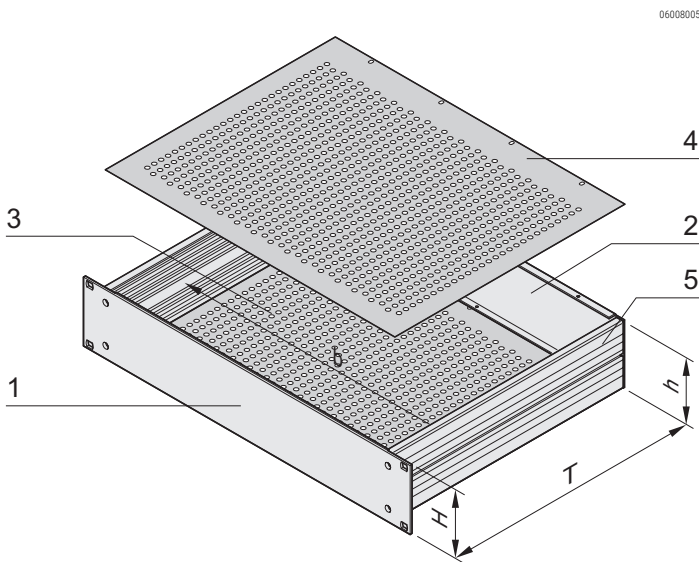

h = clear height (overall) (H - 8.1 mm)
width = 403 mm

b = clear installation

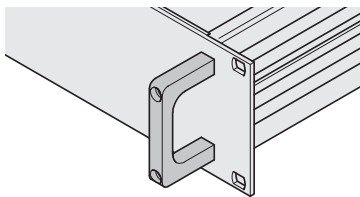

Front handle

- Complete chassis from aluminium
- Detachable rear panel for easy machining
- In the 1 U version 19" and ATX power supplies can be assembled up to a clearance of 35 mm
- EMC shielding of approx. 30 dB(A) at 1 GHz (without additional shielding material)
- In accordance with standard IEC 60297-3-100, -101, -105

DELIVERY COMPRISES (kit)

Item	Qty	Description
1	1	Front panel, Al extrusion, 3 mm; in 1 U: front anodised, rear etched; from 2 U: front and rear side of front panels clear passivated
2	1	Rear panel, Al, 2 mm, etched
3	1	Base plate, perforated, Al, 1 mm
4	1	Cover plate, perforated, Al, 1 mm
5	2	Side panel, Al extrusion, raw; with grooves for threaded insert (2 x 7); 5 U, two-piece, 3+2 U
6	1	Assembly kit

ORDER INFORMATION

Height U	Height H mm	Depth T mm	Part no.
1	43.7	220	20860-621
1	43.7	280	20860-622
2	88.1	220	20860-624
2	88.1	280	20860-625
2	88.1	340	20860-626
3	132.6	280	20860-627
3	132.6	340	20860-628
3	132.6	400	20860-629
3	132.6	460	20860-630
4	177.0	340	20860-632
4	177.0	400	20860-633
4	177.0	460	20860-634
5	221.5	460	20860-635

EMC gasketing kit Silicone/nickel gasket 2100 mm for contacting side panel/cover plate; seal, stainless steel, for front panel/cover plate, 1 kit **20860-130**

Front handles incl. assembly kit for 1 U, Al extrusion, anodised, PU 2 pieces **20860-256**

Front handles incl. assembly kit for 2 U, Al extrusion, anodised, PU 2 pieces **20860-257**

Front handles incl. assembly kit for 3 U, Al extrusion, anodised, PU 2 pieces **20860-258**

Front handles incl. assembly kit for 4 U, Al extrusion, anodised, PU 2 pieces **20860-259**

Front handles incl. assembly kit for 5 U, Al extrusion, anodised, PU 2 pieces **20860-260**

Assembly tool, Screw driver Torx20 for M4 screws **64560-027**

NOTE

- Threaded inserts to push into the side panel see page 6.121
- Telescopic slides to mount into cabinet see page 6.125

19" chassis – MultipacPRO

19" COMPLETE CHASSIS FROM ALUMINIUM, FOR ASSEMBLY OF EUROBOARDS

- Complete chassis from aluminium
- Detachable rear panel for easy machining
- EMC shielding of approx. 30 dB(A) at 1 GHz (without additional shielding material)
- In accordance with standard IEC 60297-3-100, -101, -105
- In the 1 U version 19" and ATX power supplies can be assembled up to a clearance of 35 mm

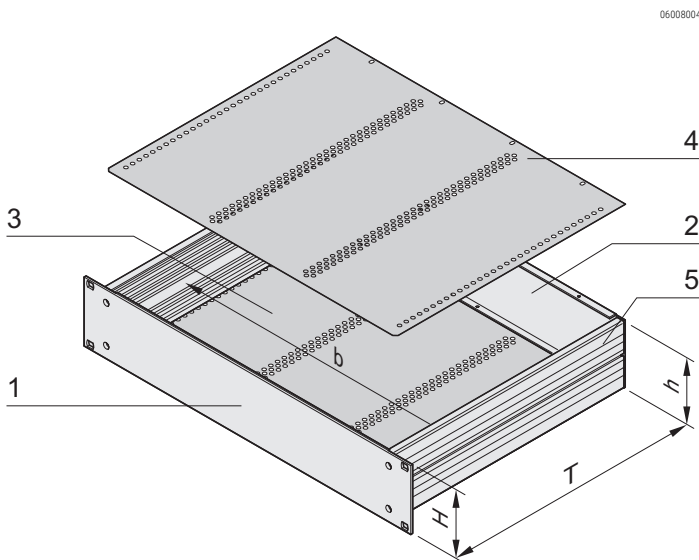

h = clear height (overall) (H - 8.1 mm)
width = 403 mm

b = clear installation

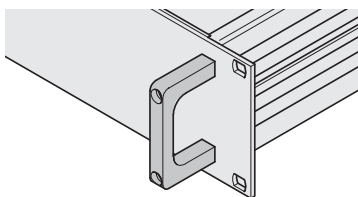

Front handle

DELIVERY COMPRISES (Kit)

Item	Qty	Description
1	1	Front panel Al extrusion, 3 mm; in 1 U: front anodised, rear etched; from 2 U: front and rear side of front panels clear passivated
2	1	Rear panel, Al, 2 mm, etched
3	1	Base plate, Al, 1 mm; with drilled holes for horizontal mounting of euroboards
4	1	Cover plate, Al, 1 mm; with drilled holes for horizontal mounting of euroboards
5	2	Side panel, Al extrusion, raw; with grooves for threaded insert (2 x 7)
6	1	Assembly kit

ORDER INFORMATION

Height U	Height H mm	Depth T mm	Part no.
1	43.7	220	20860-641
1	43.7	280	20860-642
2	88.1	280	20860-645
EMC gasketing kit PU 1 kit			20860-130
Front handles for 1 U PU 2 pieces			20860-256
Front handles for 2 U PU 2 pieces			20860-257
Euroboard mounting kit for EN 60603 connector for 1 U PU 1 kit			20860-115
Euroboard mounting kit for EN 60603 connector for 2 U PU 1 kit			20860-117
Euroboard mounting kit for insulated backplane mounting for 1 U PU 1 kit			20860-116
Euroboard mounting kit for insulated backplane mounting for 2 U PU 1 kit			20860-118
Assembly tool, Screw driver Torx20 for M4 screws			64560-027

NOTE

- Threaded inserts to push into the side panel see page 6.121
- Guide rails see page 6.124
- Telescopic slides to mount into cabinet see page 6.125

19" chassis – MultipacPRO



19" chassis – MultipacPRO

HOW TO CONFIGURE 19" ALUMINIUM CHASSIS

- Select height and depth of the basic kit
- Select further components

FOR NON-STANDARDISED ASSEMBLIES (1 ... 5 U)

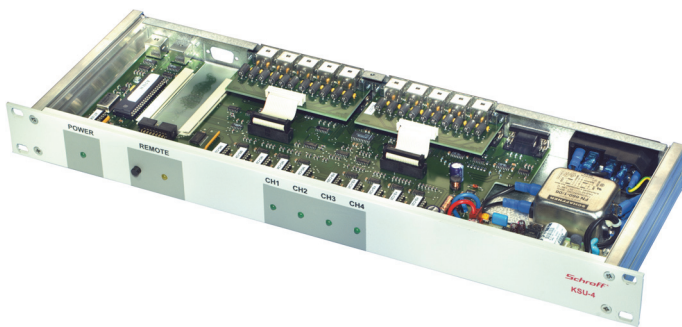

- Mounting plate
- Top cover/base plate
- Front handles
- EMC gasketing kit
- Telescopic slides

NOTE

- Non-standardised assemblies see from page 6.120

06006001

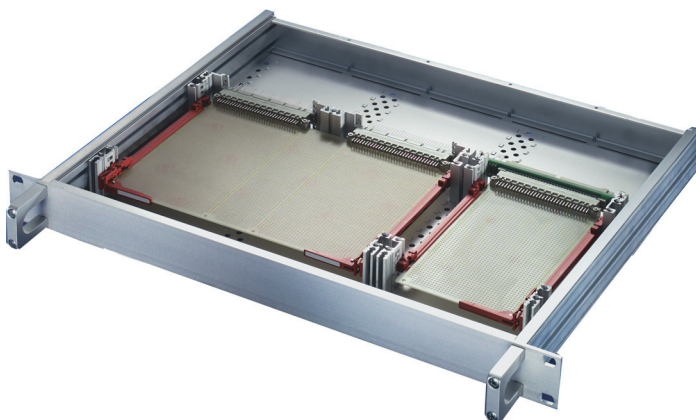

FOR STANDARDISED ASSEMBLIES (1, 2 U) IN ACCORDANCE WITH IEC 60297 -3-100, -101, -105

- Top cover/base plate for horizontal board mounting
- Internal connector or backplane fitting
- Front handles
- EMC gasketing kit
- Telescopic slide

NOTE

- Standardised assemblies from page 6.122

06002001

19" chassis – MultipacPRO

INDIVIDUAL COMPONENTS 19" CHASSIS FOR NON-STANDARDISED ASSEMBLIES

- Please select:
 - Height and depth of basic kit (1 ... 5 U, item 1+2+5)
 - Mounting plate
 - Top cover/base plate (item 3+4)
 - Front handles
 - EMC gasketing kit
 - Telescopic slides
- In accordance with IEC 60297-3-105

ORDER INFORMATION

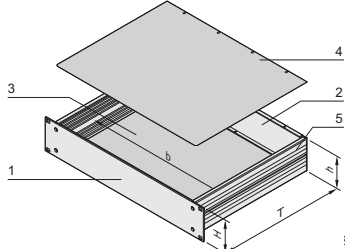
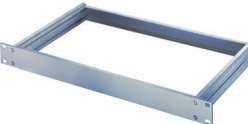
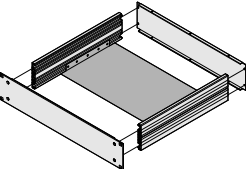
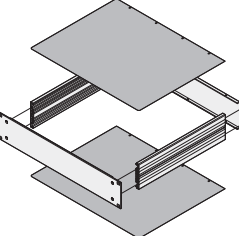
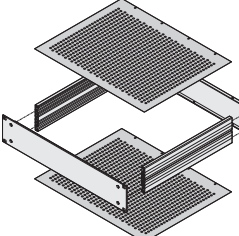
				Basic kit	Mounting plate	Top cover/base plate		
						plain	perforated	
 <p>h = clear height (overall) (H - 8.1 mm) b = clear installation width = 403 mm</p>				 <p>06002004</p>	 <p>06002058</p>	 <p>06002053</p>	 <p>06007050</p>	
Height U	Height mm	Width HP	Depth mm	PU 1 kit	Depth mm	1 piece	1 piece	1 piece
1	43.7	84	220	20860-201	150	20860-107	30860-501	30860-510
1	43.7	84	280	20860-202	210	20860-108	30860-502	30860-511
1	43.7	84	340	20860-203	270	20860-109	30860-503	30860-512
1	43.7	84	400	20860-204	330	20860-110	30860-504	30860-513
1	43.7	84	460	20860-205	390	20860-111	30860-505	30860-514
2	88.1	84	220	20860-210	150	20860-107	30860-501	30860-510
2	88.1	84	280	20860-211	210	20860-108	30860-502	30860-511
2	88.1	84	340	20860-212	270	20860-109	30860-503	30860-512
2	88.1	84	400	20860-213	330	20860-110	30860-504	30860-513
2	88.1	84	460	20860-214	390	20860-111	30860-505	30860-514
3	132.6	84	280	20860-219	210	20860-108	30860-502	30860-511
3	132.6	84	340	20860-220	270	20860-109	30860-503	30860-512
3	132.6	84	400	20860-221	330	20860-110	30860-504	30860-513
3	132.6	84	460	20860-222	390	20860-111	30860-505	30860-514
4	177.0	84	280	20860-228	210	20860-108	30860-502	30860-511
4	177.0	84	340	20860-229	270	20860-109	30860-503	30860-512
4	177.0	84	400	20860-230	330	20860-110	30860-504	30860-513
4	177.0	84	460	20860-231	390	20860-111	30860-505	30860-514
5	221.5	84	460	20860-240	390	20860-111	30860-505	30860-514

NOTE

Assembly tool, Screw driver Torx20 for M4 screws
(Assembly of Front panels, rear panels, handles,
internal mounting kit)

64560-027



Assembly tool, Screw driver Torx10 for M3 screws
(Assembly of mounting plate)

64560-230

19" chassis – MultipacPRO

INDIVIDUAL COMPONENTS 19" CHASSIS FOR NON-STANDARDISED ASSEMBLIES

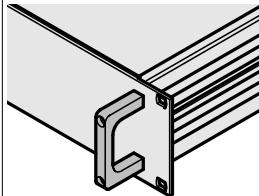
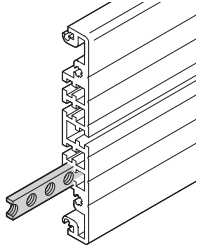
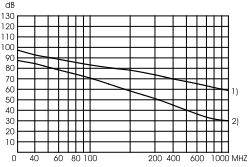
ORDER INFORMATION

				Front handles	Threaded insert M3 for extruded side panel	EMC gasketing kit Shielding upgrade of approx. 30 dB	Assembly kit for telescopic slides
				 06002052 Al extrusion, anodised, incl. assembly kit see page 5.108	 06007051 St, 2 mm, zinc-plated, height 7 mm, length 431.3 mm, M3 hole clearance 1 HP = 5.08 mm	 esa44237 Gasket 2100 mm, silicone/nickel, for contacting side panel/ top cover and base plate; sawtooth gasket 400 mm; stainless steel, for contacting front panel/ top cover and base plate	 Assembly kit and adaptor bracket for the cabinets VARISTAR, eurorack, minirack; for mounting the 19in. chassis on telescopic slides; please order telescopic slides separately see page 6.125
Height U	Height mm	Width HP	Depth D mm	PU 2 pieces	1 piece	PU 1 kit	PU 1 kit
1	43.7	84	220	20860-256			
1	43.7	84	280				
1	43.7	84	340				
1	43.7	84	400				
1	43.7	84	460				
2	88.1	84	220	30821-589		20860-130	20860-131
2	88.1	84	280				
2	88.1	84	340				
2	88.1	84	400				
2	88.1	84	460				
3	132.6	84	280	20860-258			
3	132.6	84	340				
3	132.6	84	400				
3	132.6	84	460				
4	177.0	84	280	20860-259			
4	177.0	84	340				
4	177.0	84	400				
4	177.0	84	460				
5	221.5	84	460	20860-260			

NOTE

Assembly tool, Screw driver Torx20 for M4 screws
(Assembly of Front panels, rear panels, handles, internal mounting kit)
Assembly tool, Screw driver Torx10 for M3 screws
(Assembly of mounting plate)

64560-027

64560-230

- Further sizes available on request
- Al extrusion side panels up to 1000 mm length available on request
- Telescopic slides see page 6.125

19" chassis – MultipacPRO

INDIVIDUAL COMPONENTS 19" CHASSIS FOR STANDARDISED 19" ASSEMBLIES

- Please select
 - Height and depth of basic kit (1, 2 U, items 1+2+5)
 - Top cover/base plate for horizontal board mounting (items 3+4)
 - Internal mounting for connector or backplane
 - Front handles
 - EMC gasketing kit
 - Telescopic slides
- In accordance with IEC 60297-3-100, 101, 105

ORDER INFORMATION

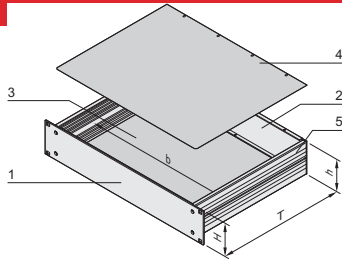
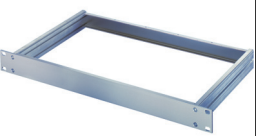
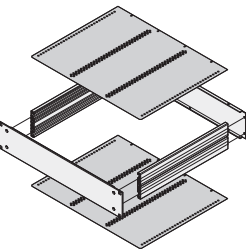
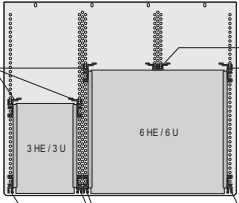
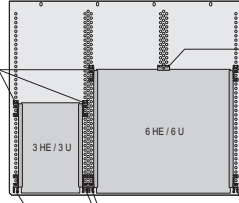
				Basic kit	Mounting of euroboards Top cover/base plate	for EN 60603 connectors	for insulated backplane assembly
 <p>06008052</p> <p>h = clear height (overall) (H - 8.1 mm) b = clear installation width = 403 mm</p>				 <p>06002004</p> <p>1 x Al front panel, 3 mm; 2 x extruded Al side panels; 1 x Al rear panel, 2 mm, incl. fixing material kit</p>	 <p>06008053</p> <p>Al, 1 mm; with drilled holes for horizontal mounting of euroboards</p>	 <p>06003050</p> <p>2 x front horizontal rails, 2 x rear horizontal rails with Z, 2 x threaded inserts; Sufficient for one 3 U board or one 6 U board</p>	 <p>06003051</p> <p>2 x front horizontal rails, 2 x rear horizontal rails, 4 x threaded inserts, 4 x insulation strips PBT, UL 94; Sufficient for one 3 U board or one 6 U board (6 HP for 1 U, 15 HP for 2 U)</p>
Height U	Height mm	Width HP	Depth D mm	PU 1 kit	1 piece	PU 1 kit	PU 1 kit
1	43.7	84	220	20860-201	30860-519	20860-115	20860-116
1	43.7	84	280	20860-202	30860-520	20860-115	20860-116
1	43.7	84	340	20860-203	30860-521	20860-115	20860-116
1	43.7	84	400	20860-204	30860-522	20860-115	20860-116
1	43.7	84	460	20860-205	30860-523	20860-115	20860-116
2	88.1	84	220	20860-210	30860-519	20860-117	20860-118
2	88.1	84	280	20860-211	30860-520	20860-117	20860-118
2	88.1	84	340	20860-212	30860-521	20860-117	20860-118
2	88.1	84	400	20860-213	30860-522	20860-117	20860-118
2	88.1	84	460	20860-214	30860-523	20860-117	20860-118

NOTE

Assembly tool, Screw driver Torx20 for M4 screws
(Assembly of Front panels, rear panels, handles,
internal mounting kit)

64560-027



Assembly tool, Screw driver Torx10 for M3 screws
(Assembly of mounting plate)

64560-230

19" chassis – MultipacPRO

INDIVIDUAL COMPONENTS 19" CHASSIS FOR STANDARDISED 19" ASSEMBLIES

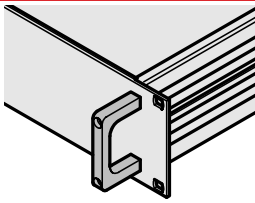
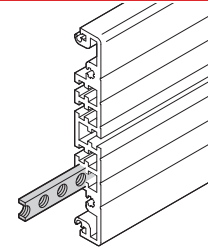
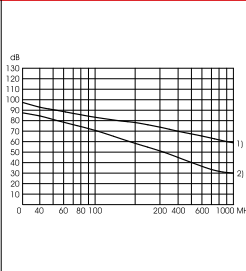
ORDER INFORMATION

				Front handles	Threaded insert M3 for extruded side panel	EMC gasketing kit for shielding upgrade of approx. 30 dB	Assembly kit for fixing on telescopic slides
				 <p>06002052</p> <p>Al extrusion, anodised, incl. assembly kit see page 5.108</p>	 <p>06007051</p> <p>St, 2 mm, zinc-plated, height 7 mm, length 431.3 mm, M3 hole clearance 1 HP = 5.08 mm</p>	 <p>esa44237</p> <p>Gasket 2100 mm, silicone/nickel, for contacting side panel/ top cover and base plate; sawtooth gasket 400 mm; stainless steel, for contacting front panel/ top cover and base plate</p>	 <p>06094004</p> <p>Assembly kit and adaptor bracket for the cabinets VARISTAR, eurorack, minirack; for mounting the 19in. chassis on telescopic slides; please order telescopic slides separately see page 6.125</p>
Height U	Height mm	Width HP	Depth D mm	PU 2 pieces	1 piece	PU 1 kit	PU 1 kit
1	43.7	84	220	20860-256	30821-589	20860-130	20860-131
1	43.7	84	280				
1	43.7	84	340				
1	43.7	84	400				
1	43.7	84	460				
2	88.1	84	220	20860-257	30821-589	20860-130	20860-131
2	88.1	84	280				
2	88.1	84	340				
2	88.1	84	400				
2	88.1	84	460				

NOTE

Assembly tool, Screw driver Torx20 for M4 screws
(Assembly of Front panels, rear panels, handles, internal mounting kit)

Assembly tool, Screw driver Torx10 for M3 screws
(Assembly of mounting plate)

- Further sizes available on request
- Al extrusion side panels up to 1000 mm length available on request
- Telescopic slides see page 6.125

19" chassis – MultipacPRO

GUIDE RAILS FOR BOARDS WITHOUT FRONT PANELS, ONE-PIECE, GROOVE WIDTH 2 MM

ORDER INFORMATION

Board length			Groove width	Colour	
mm	mm	mm	mm	mm	PU 10 pieces ²⁾
160	2	red			24568-363
220	2	red			24568-364
280	2	red			24568-381
340	2	red			24568-382

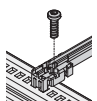
Retention screw, PU 100 pieces		24560-141
-----------------------------------	---	------------------

2) Part no. includes one packing unit (PU); delivery is exclusively made in PU

GUIDE RAIL ACCESSORIES

ORDER INFORMATION

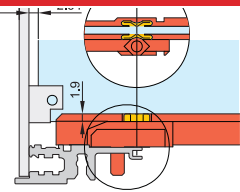
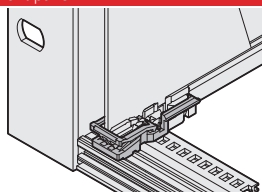
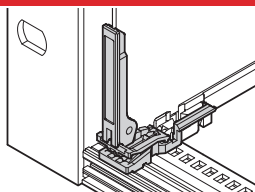
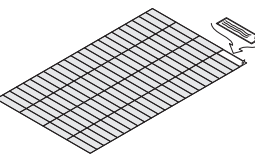
ESD clip for guide rails	Board locking C for PCBs without front panel	C board handle for board locking	Identification strips for board handle
 <p>04503050</p> <p>Spring steel, tin-plated, ensures conductive contact between board and horizontal rail, on both the solder side and the component side</p>	 <p>04805050</p> <p>PBT, UL 94 V-0, red, to fix the PCB in the subrack (also slot 1), can also be used without board handle, minimum distance 3 HP</p>	 <p>04805051</p> <p>PBT, UL 94 V-0, red, insertion/ extraction function with connection to board locking (also slot 1), mounting directly behind front panel (upper and lower), minimum distance 3 HP</p>	 <p>06108076</p> <p>Polyester film, 31 x 4 mm, self-adhesive, white/matt (1 A4 sheet contains 438 pieces) PBT, UL 94 V-0</p>
PU 50 pieces 24560-255	PU 10 pieces 24560-377	PU 10 pieces 24560-378	1 piece 60817-228

19" chassis – MultipacPRO

UNIVERSAL 1 U TELESCOPIC SLIDE

- Static load-carrying capacity per pair 23 - 39 kg
- Lateral mounting on the 19" uprights (19" plane remains free for fixing the extension/drawer)
- Can be removed
- Extension length > 100 %
- Rail width $k = 9.7$ mm, max. installation width of extension/drawer $w = 429$ mm



DELIVERY COMPRISES

Item	Qty	Description
1	2	Telescopic slide, St, zinc-plated

ORDER INFORMATION

Length L	Extension length Y	Load-carrying capacity P	Part no.
mm	mm	kg	
356	381	39	20110-090
406	432	36	20110-091
457	483	34	20110-092
508	533	32	20110-093
559	584	29	20110-094
610	635	27	20110-095
660	686	23	20110-096
711	737	23	20110-097

NOTE

- For mounting into Schroff cabinets please order assembly kit separately, see page 6.123

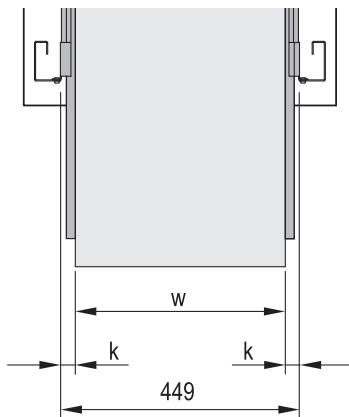

k = rail width, w = max. installation width

Dimensions table

L	Internal part									External part		
	A	B	C	D	E	F	G	X	O	P	Q	
356	29.5	92.1	184.2	276.2	-	-	-	349.3	304.6	317.3	330.0	
406	29.5	92.1	184.2	276.2	-	-	-	349.3	355.4	368.1	380.8	
457	29.5	92.1	184.2	276.2	-	-	-	349.3	406.4	419.1	431.8	
508	89.9	92.1	184.2	276.2	368.3	-	-	501.7	457.4	470.1	482.8	
559	89.9	92.1	184.2	276.2	368.3	-	-	501.7	508.1	520.8	533.5	
610	89.9	92.1	184.2	276.2	368.3	-	-	501.7	558.6	571.3	584.0	
660	7.4	92.1	184.2	276.2	368.3	460.4	552.4	603.3	609.4	622.1	634.8	
711	7.4	92.1	184.2	276.2	368.3	460.4	552.4	603.3	660.2	672.9	685.6	

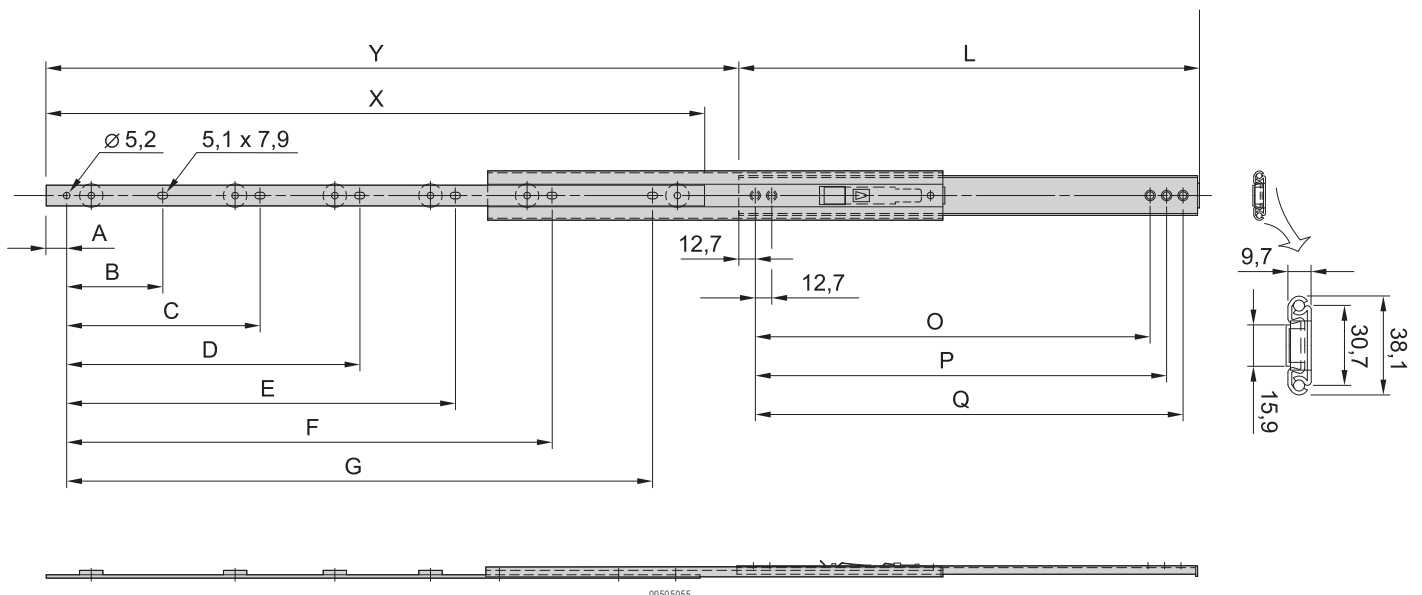

19" chassis – MultipacPRO

UNIVERSAL 2 U, SLIM TELESCOPIC SLIDE



- Static load-carrying capacity per pair 46 - 57 kg
- Lateral mounting on the 19" uprights (19" plane remains free for fixing the extension/drawer)
- Locking at full extension
- Extension length > 110 %
- Rail width $k = 9,7$ mm, max. installation width of extension/drawer $w = 429$ mm

DELIVERY COMPRISES

Item	Qty	Description
1	2	Telescopic slide, St, zinc-plated

ORDER INFORMATION

Length L	Extension length Y	Load-carrying capacity P	Part no.
mm	mm	kg	
356	432	57	20110-071
406	483	55	20110-072
457	533	55	20110-073
508	584	55	20110-074
559	635	46	20110-075
584	660	46	20110-076
610	686	46	20110-077

Accessories

Assembly kit for VARISTAR, for assembly of 2 telescopic slides, PU 1 kit	21120-161
Assembly kit for eurorack, for assembly of 2 telescopic slides, PU 1 kit	21120-162
Telescopic slides mounting kit for NOVASTAR, to mount 2 telescopic slides, PU 1 kit	21120-163
Delivery: supplied loose with cabinet or frame	Part no./35

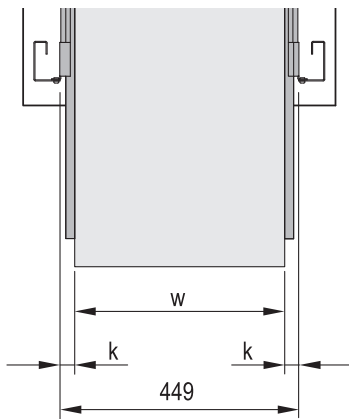

k = rail width, w = max. installation width

Dimensions table

Length L	Internal part				External part		
	A	w	C	X	D	E	F
356	101.6	184.2	304.8	356.0	101.6	228.6	330.2
406	127.0	209.6	355.6	406.0	127.0	254.0	381.0
457	127.0	235.0	406.4	457.0	152.4	279.4	431.8
508	152.4	260.4	457.2	508.0	152.4	330.2	482.6
559	203.2	412.8	508.0	559.0	177.8	355.6	533.4
584	203.2	431.8	533.4	584.0	177.8	381.0	558.8
610	203.2	438.2	558.8	610.0	203.2	381.0	584.2

NOTE

- To mount on 19" plane please order assembly kit separately
- Universal telescopic rails can also be fitted without additional components in non-standard applications, thus also in other than 19" cabinets

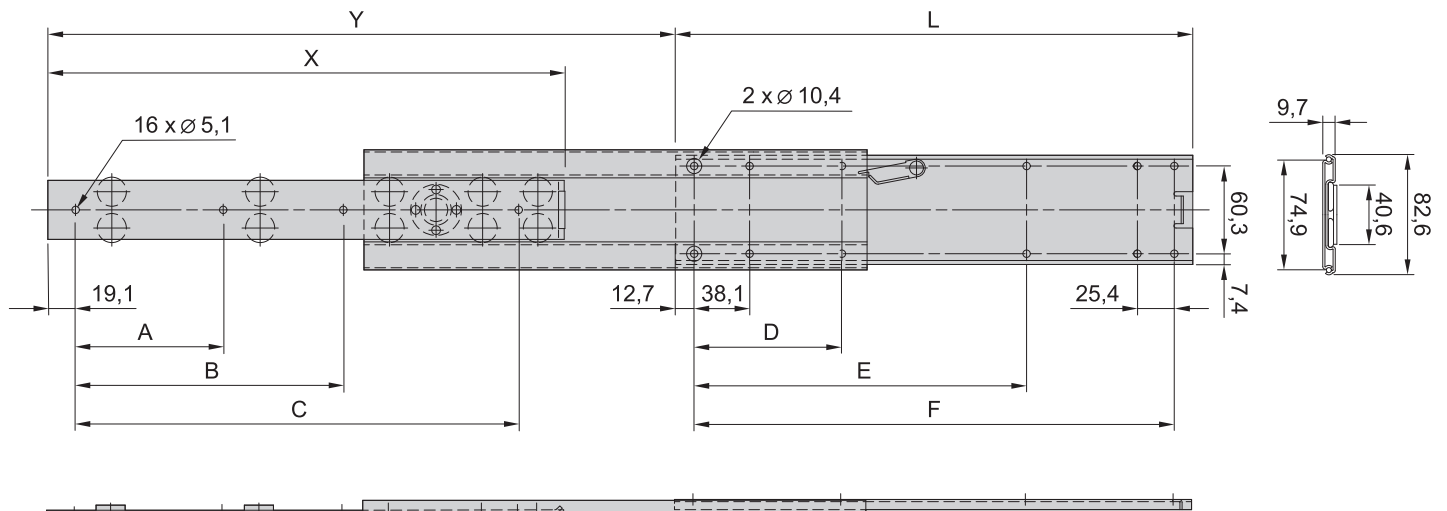

19" chassis – MultipacPRO

CUSTOMISED SOLUTIONS



Application: Different cut-outs

06002006

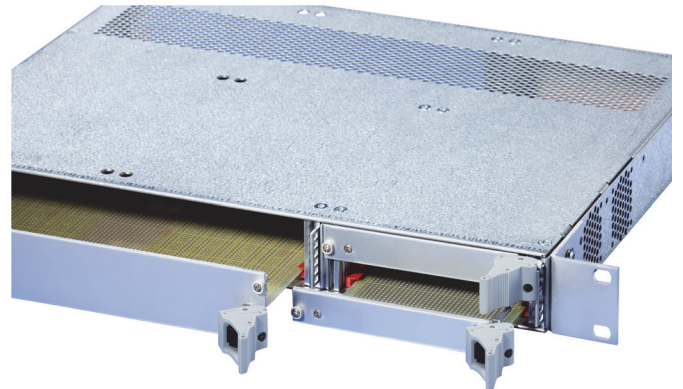

Application: Combined 3 U and 6 U assembly

06002007



Application: 2 U version with 2 x 3 U assembly

06002005



Application: 1 U multipacPRO (pizza box) complete from steel plate; 19" brackets can be removed if required

06008006



Application: 1 U multipacPRO complete from steel plate; front panel in aluminium with cut-outs

06108007



Application: 1 U multipacPRO complete from steel plate; printed 19" front panel in aluminium with cut-outs

06101008

North America

Warwick, RI, USA

Tel +1.800.525.4682

San Diego, CA, USA

Tel +1.800.854.7086

Europe, Middle East & India

Straubenhardt, Germany

Tel +49 7082 794 0

Betschdorf, France

Tel +33 3 88 90 64 90

Warsaw, Poland

Tel +48 22 209 98 35

Hemel Hempstead,

Great Britain

Tel +44 1442 24 04 71

Lainate, Italy

Tel +39 02 932 714 1

Dubai, United Arab Emirates

Tel +971 4 37 81 700

Bangalore, India

Tel +91 80 67152000

Istanbul, Turkey

Tel +90 216 250 7374

Asia Pacific

Shanghai, China

Tel +86 21 2412 6943

Singapore

Tel +65 6768 5800

Shin-Yokohama, Japan

Tel +81 45 476 0271

Our powerful portfolio of brands:

CADDY ERICO HOFFMAN RAYCHEM SCHROFF TRACER



[nVent.com/SCHROFF](https://www.nVent.com/SCHROFF)