

Description

AH1889 is a high sensitivity dual output Unipolar Hall effect IC which can detect either a North or South pole independently and switch one of its two outputs with internal pull up and pull down capability. The AH1889 is mainly designed for low voltage applications which require a quick response time and can operate over the supply voltage of 1.65V to 3.6V. To minimize PCB space AH1889 outputs have internal pull up and pull down capability and is packaged in a small low profile SOT553 package.

A South pole of sufficient strength will turn OUTPUT1 on and a North pole of sufficient strength will turn on OUTPUT2. While the magnetic flux density (B) perpendicular to the package is larger than operate point Bops or Bopn, the appropriate output will be turned on (pulled low), the output is held until B is lower than release point Brps or Brpn, then turned off (high). The outputs will be turned off and will remain off when there is no magnetic field.

Features

- Two Monolithic Unipolar Hall Effect Sensor Switch
 - Operation with a South Pole (OUTPUT1)
 - Operation with a North Pole (OUTPUT2)
- Supply Voltage of 1.65V to 3.6V
- Quick Response Time Without Sleep Mode
- Chopper Stabilized Design Provides:
 - Superior Temperature Stability
 - Extremely low Switch-Point Drift
 - Enhanced immunity to physical stress
- Good RF Noise Immunity
- -40°C to +85°C Operating Temperature
- ESD (Human Body Model) >4kV
- Small and Low Profile SOT553 package
- **Totally Lead-Free & Fully RoHS Compliant (Notes 1 & 2)**
- **Halogen and Antimony Free. "Green" Device (Note 3)**

- Notes:
1. No purposely added lead. Fully EU Directive 2002/95/EC (RoHS) & 2011/65/EU (RoHS 2) compliant.
 2. See http://www.diodes.com/quality/lead_free.html for more information about Diodes Incorporated's definitions of Halogen- and Antimony-free, "Green" and Lead-free.
 3. Halogen- and Antimony-free "Green" products are defined as those which contain <900ppm bromine, <900ppm chlorine (<1500ppm total Br + Cl) and <1000ppm antimony compounds.

Pin Assignments

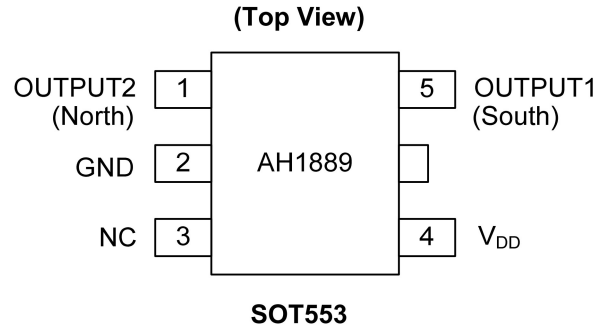

Applications

- Position and proximity detection for consumer, office equipments and industrial applications
- Open and close detect switches for home appliances
- Door, lids, tray position detect switches
- Magnetic field direction detection
- Contact-less switches for consumer and industrial applications

Typical Applications Circuit

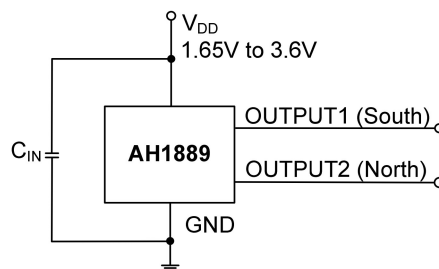

- Note: 4. C_{IN} is for power stabilization and to strengthen the noise immunity, the recommended capacitance 100nF typical.

Pin Descriptions

Package: SOT553

Pin Number	Pin Name	Function
1	OUTPUT2	North Pole Selecting Output Pin (active low)
2	GND	Ground
3	NC	No Connection (Note 5)
4	V _{DD}	Power Supply Voltage
5	OUTPUT1	South Pole Detecting Output Pin (active low)

Note: 5. NC is "No Connection" pin and is not connected internally. This pin can be left open or tied to ground.

Functional Block Diagram

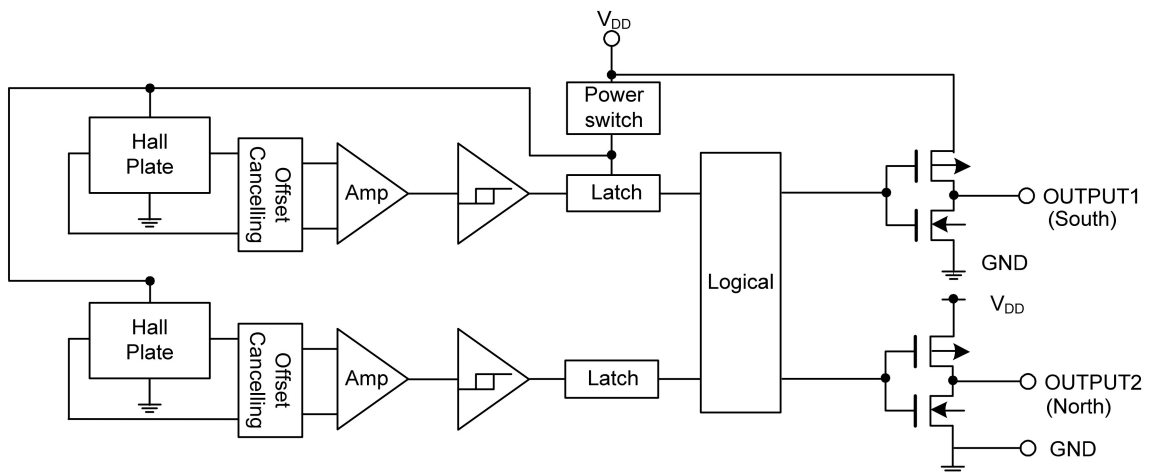

Absolute Maximum Ratings (Note 6) (@T_A = +25°C, unless otherwise specified.)

Symbol	Characteristics	Values	Unit	
V _{DD}	Supply Voltage (Note 7)	5	V	
V _{DD_REV}	Reverse Supply Voltage	-0.3	V	
I _{OUTPUT}	Output current (source and sink)	1	mA	
B	Magnetic Flux Density	Unlimited		
P _D	Package Power Dissipation	SOT553	230	mW
T _s	Storage Temperature Range	-65 to +150		°C
T _J	Maximum Junction Temperature	150		°C
ESD	Human Body Model ESD capability	4		kV

Notes: 6. Stresses greater than the 'Absolute Maximum Ratings' specified above may cause permanent damage to the device. These are stress ratings only; functional operation of the device at these or any other conditions exceeding those indicated in this specification is not implied. Device reliability may be affected by exposure to absolute maximum rating conditions for extended periods of time.
7. The absolute maximum V_{DD} of 6V is a transient stress rating and is not meant as a functional operating condition. It is not recommended to operate the device at the absolute maximum rated conditions for any period of time.

NEW PRODUCT

Recommended Operating Conditions (@T_A = +25°C, unless otherwise specified.)

Symbol	Characteristic	Conditions	Rating	Unit
V _{DD}	Supply Voltage	Operating	1.65 to 3.6	V
T _A	Operating Temperature Range	Operating	-40 to +85	°C

Electrical Characteristics (Note 8) (@T_A = +25°C, V_{DD} = 1.8V, unless otherwise specified.)

Symbol	Characteristic	Conditions	Min	Typ	Max	Unit
V _{OH}	OUTPUT1 and OUTPUT2 High Voltage (off)	I _{OUT} = -0.5mA	V _{DD} -0.2	—	—	V
V _{OL}	OUTPUT1 and OUTPUT2 Low Voltage (on)	I _{OUT} = 0.5mA	—	0.1	0.2	V
I _{DD}	Supply Current	V _{DD} = 1.8V Outputs Off	—	2.1	—	mA
		V _{DD} = 3.6V Outputs Off	—	5	—	mA

Note: 8. When power is initially turned on, the operating V_{DD} (1.65V to 3.6V) must be applied to guaranteed the output.

Magnetic Characteristics (Note 9, 10, 11) (@T_A = +25°C, V_{DD} = 1.8V, unless otherwise specified.)

(1mT=10 Gauss)

Output	Symbol	Characteristic	Min	Typ	Max	Unit
OUTPUT1	Bops (South pole to part marking side)	Operation Point	—	35	50	Gauss
	Brps (South pole to part marking side)	Release point	6	20	—	
OUTPUT2	Bopn (North pole to part marking side)	Operation Point	-50	-35	—	
	Brpn (North pole to part marking side)	Release point	—	-20	-6	
	B _{hy} (B _{opx} - B _{rp} x)	Hysteresis	—	8	—	

Notes: 9. Typical data is at T_A = +25°C, V_{DD} = 3V, and for design information only.
 10. Bops and Brps for OUTPUT1 pin responds to South pole only; Bopn and Brpn for OUTPUT2 pin responds to North pole only.
 11. Magnetic characteristics may vary with operating temperature and after soldering.

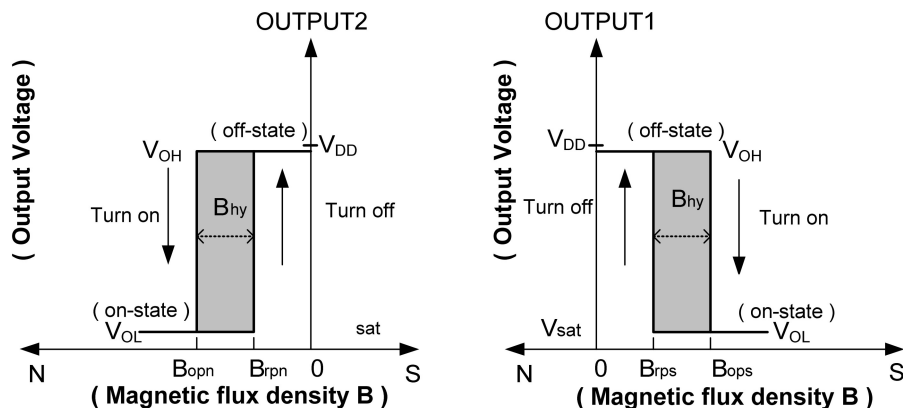

Typical Operating Characteristics

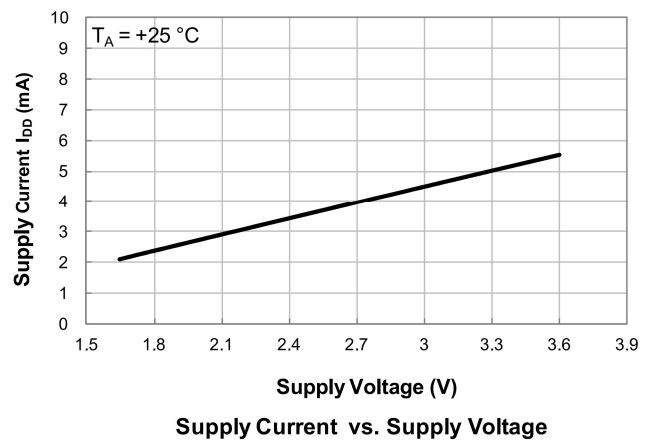
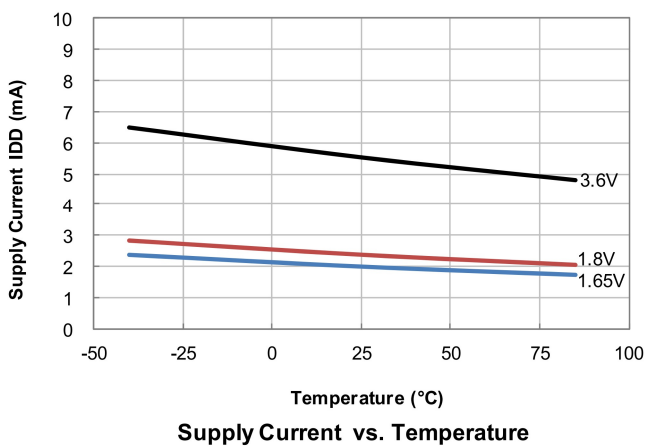
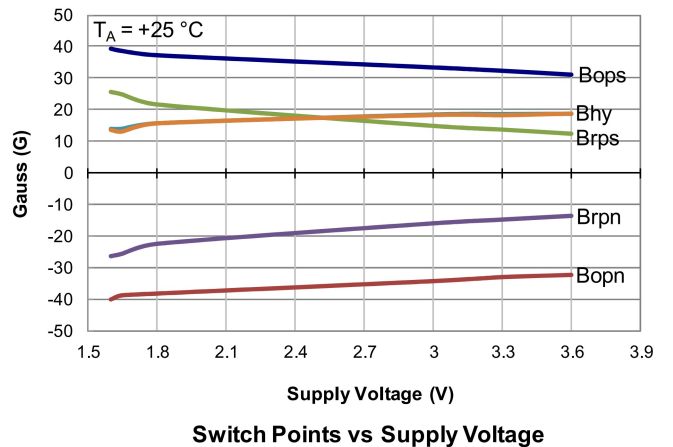
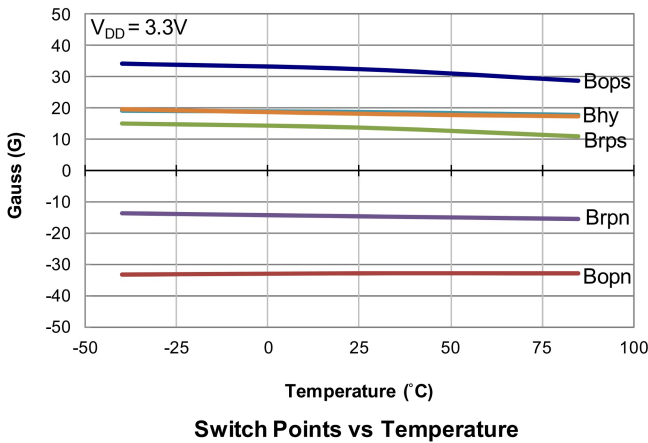
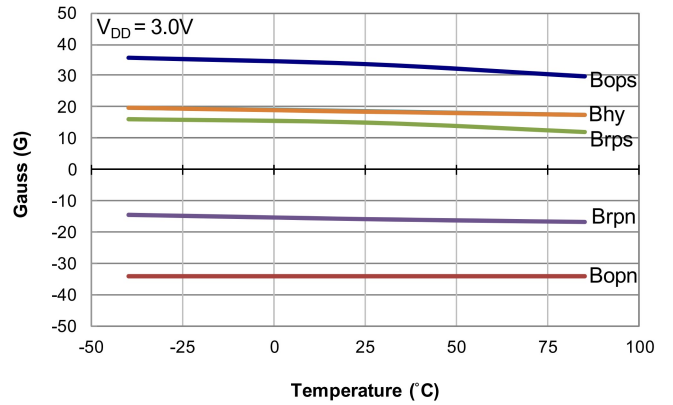
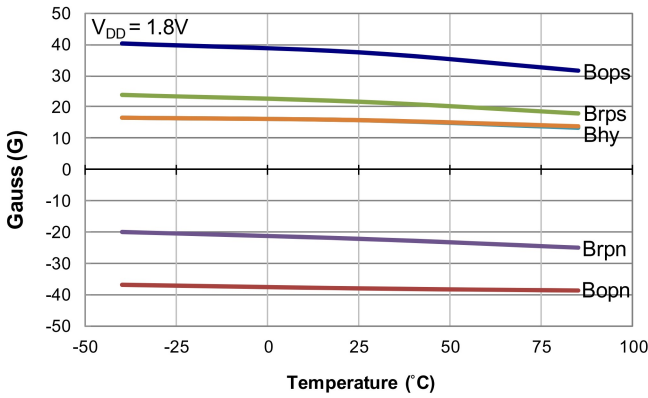

Thermal Performance Characteristics

T _A (°C)	25	50	60	70	80	85	90	100	110	120	130	140	150
P _D (mW)	230	184	166	147	129	120	110	92	74	55	37	18	0

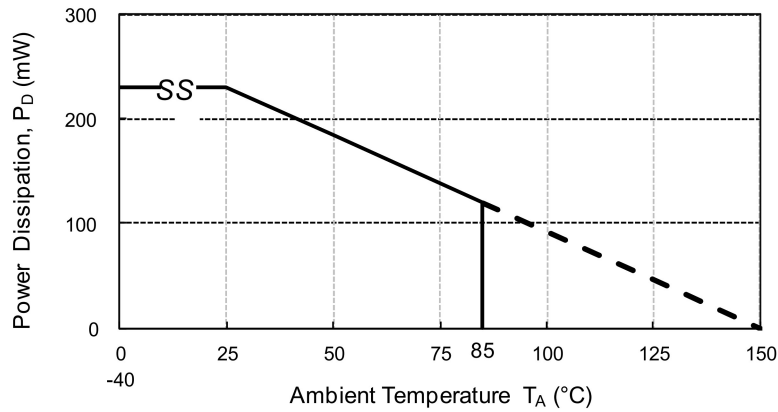

Power Dissipation Curve

Ordering Information

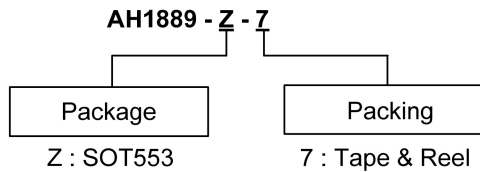

Part Number	Package Code	Packaging	7" Tape and Reel	
			Quantity	Part Number Suffix
AH1889-Z-7	Z	SOT553	3000/Tape & Reel	-7

Marking Information

(1) Package Type: SOT553

(Top View)

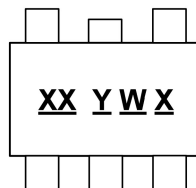

- XX : Identification Code
- Y : Year : 0 to 9
- W : Week : A to Z : 1~26 week;
a to z : 27~52 week; z represents 52 and 53 week
- X : Internal code

Part Number	Package	Identification Code
AH1889	SOT553	KX

NEW PRODUCT

Package Outline Dimensions (All dimensions in mm.)

Please see AP02002 at <http://www.diodes.com/datasheets/ap02002.pdf> for latest version.

(1) Package Type: SOT553

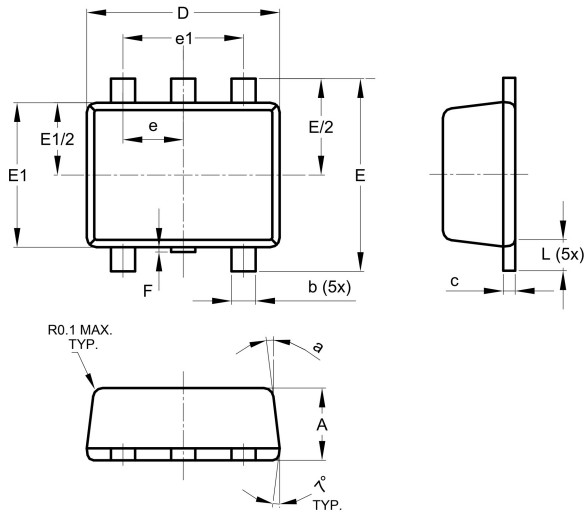

SOT553			
Dim	Min	Max	Typ
A	0.55	0.62	0.60
b	0.15	0.30	0.20
c	0.10	0.18	0.15
D	1.50	1.70	1.60
E	1.55	1.70	1.60
E1	1.10	1.25	1.20
e	0.50 BSC		
e1	1.00 BSC		
F	0.00	0.10	—
L	0.10	0.30	0.20
a	6°	8°	7°
All Dimensions in mm			

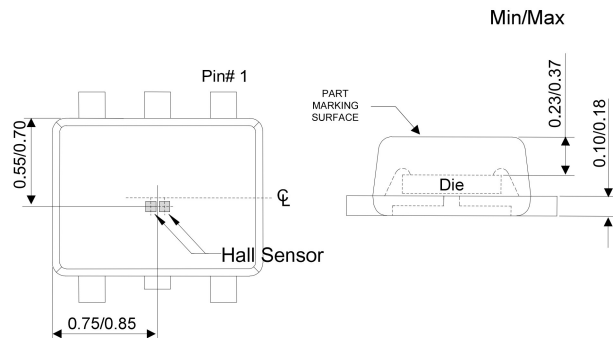

Sensor Location

Suggested Pad Layout

Please see AP02001 at <http://www.diodes.com/datasheets/ap02001.pdf> for the latest version.

(1) Package Type: SOT553

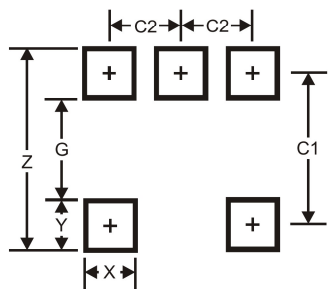

Dimensions	Value (in mm)
Z	2.2
G	1.2
X	0.375
Y	0.5
C1	1.7
C2	0.5

IMPORTANT NOTICE

DIODES INCORPORATED MAKES NO WARRANTY OF ANY KIND, EXPRESS OR IMPLIED, WITH REGARDS TO THIS DOCUMENT, INCLUDING, BUT NOT LIMITED TO, THE IMPLIED WARRANTIES OF MERCHANTABILITY AND FITNESS FOR A PARTICULAR PURPOSE (AND THEIR EQUIVALENTS UNDER THE LAWS OF ANY JURISDICTION).

Diodes Incorporated and its subsidiaries reserve the right to make modifications, enhancements, improvements, corrections or other changes without further notice to this document and any product described herein. Diodes Incorporated does not assume any liability arising out of the application or use of this document or any product described herein; neither does Diodes Incorporated convey any license under its patent or trademark rights, nor the rights of others. Any Customer or user of this document or products described herein in such applications shall assume all risks of such use and will agree to hold Diodes Incorporated and all the companies whose products are represented on Diodes Incorporated website, harmless against all damages.

Diodes Incorporated does not warrant or accept any liability whatsoever in respect of any products purchased through unauthorized sales channel. Should Customers purchase or use Diodes Incorporated products for any unintended or unauthorized application, Customers shall indemnify and hold Diodes Incorporated and its representatives harmless against all claims, damages, expenses, and attorney fees arising out of, directly or indirectly, any claim of personal injury or death associated with such unintended or unauthorized application.

Products described herein may be covered by one or more United States, international or foreign patents pending. Product names and markings noted herein may also be covered by one or more United States, international or foreign trademarks.

This document is written in English but may be translated into multiple languages for reference. Only the English version of this document is the final and determinative format released by Diodes Incorporated.

LIFE SUPPORT

Diodes Incorporated products are specifically not authorized for use as critical components in life support devices or systems without the express written approval of the Chief Executive Officer of Diodes Incorporated. As used herein:

A. Life support devices or systems are devices or systems which:

1. are intended to implant into the body, or
2. support or sustain life and whose failure to perform when properly used in accordance with instructions for use provided in the labeling can be reasonably expected to result in significant injury to the user.

B. A critical component is any component in a life support device or system whose failure to perform can be reasonably expected to cause the failure of the life support device or to affect its safety or effectiveness.

Customers represent that they have all necessary expertise in the safety and regulatory ramifications of their life support devices or systems, and acknowledge and agree that they are solely responsible for all legal, regulatory and safety-related requirements concerning their products and any use of Diodes Incorporated products in such safety-critical, life support devices or systems, notwithstanding any devices- or systems-related information or support that may be provided by Diodes Incorporated. Further, Customers must fully indemnify Diodes Incorporated and its representatives against any damages arising out of the use of Diodes Incorporated products in such safety-critical, life support devices or systems.

Copyright © 2013, Diodes Incorporated

www.diodes.com