

MSA-0600

Cascadable Silicon Bipolar MMIC Amplifier



Data Sheet

Description

The MSA-0600 is a high performance silicon bipolar Monolithic Microwave Integrated Circuit (MMIC) chip. This MMIC is designed for use as a general purpose 50 W gain block. Typical applications include narrow and broad band IF and RF amplifiers in commercial, industrial and military applications.

The MSA-series is fabricated using HP's 10 GHz f_T , 25 GHz f_{MAX} , silicon bipolar MMIC process which uses nitride self-alignment, ion implantation, and gold metallization to achieve excellent performance, uniformity and reliability. The use of an external bias resistor for temperature and current stability also allows bias flexibility.

The recommended assembly procedure is gold-eutectic die attach at 400°C and either wedge or ball bonding using 0.7 mil gold wire.^[1] See APPLICATIONS section, "Chip Use".

Typical Biasing Configuration

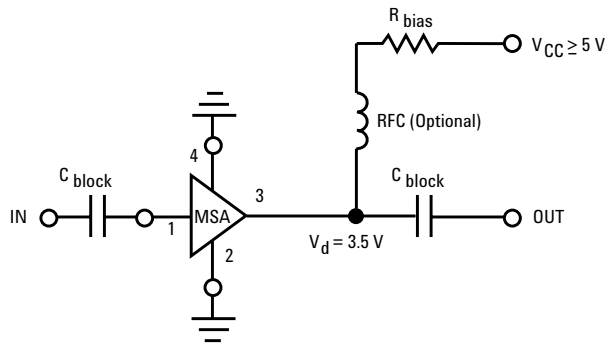

Features

- Cascadable 50 Ω Gain Block
- Low Operating Voltage (3.5 V typical V_d)
- 3 dB Bandwidth: DC to 1.0 GHz
- High Gain: 19.5 dB Typical at 0.5 GHz
- Low Noise Figure: 2.8 dB Typical at 0.5 GHz

Chip Outline [1]

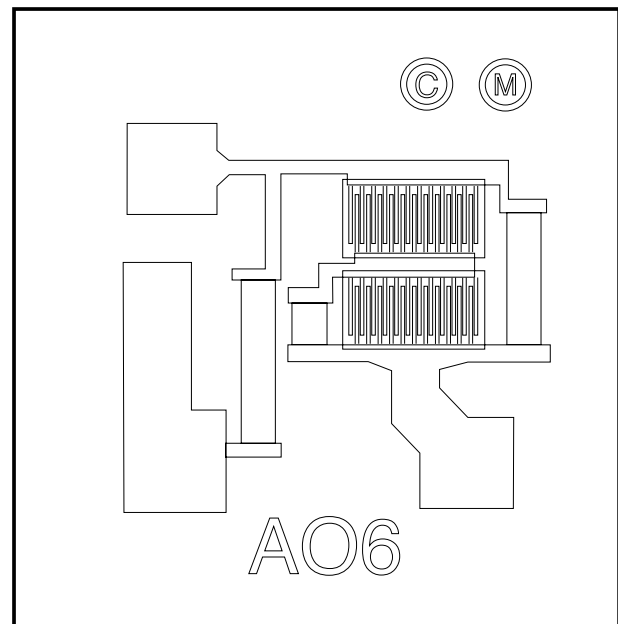

Note:

1. This chip contains additional biasing options. The performance specified applies only to the bias option whose bond pads are indicated on the chip outline. Refer to the APPLICATIONS section "Silicon MMIC Chip Use" for additional information.

MSA-0600 Absolute Maximum Ratings

Parameter	Absolute Maximum ⁽¹⁾
Device Current	50 mA
Power Dissipation ^(2,3)	200 mW
RF Input Power	+13 dBm
Junction Temperature	200 °C
Storage Temperature	-65 to 200 °C

Thermal Resistance ^(2,4) :

$$\theta_{jc} = 50 \text{ }^{\circ}\text{C/W}$$

Notes:

1. Permanent damage may occur if any of these limits are exceeded.
2. T_{Mounting Surface} (T_{MS}) = 25°C.
3. Derate at 20 mW/°C for T_{Mounting Surface} > 190°C.
4. The small spot size of this technique results in a higher, though more accurate determination of θ_{jc} than do alternate methods. See MEASUREMENTS section "Thermal Resistance" for more information.

Electrical Specifications ⁽¹⁾, T_A = 25°C

Symbol	Parameters and Test Conditions ⁽²⁾ : I _d = 16 mA, Z _o = 50 Ω	Units	Min.	Typ.	Max.
G _P	Power Gain (S ₂₁ ²)	f = 0.1 GHz		20.5	
ΔG _P	Gain Flatness	f = 0.1 to 0.6 GHz		± 0.7	
f _{3dB}	3 dB Bandwidth			1.0	
VSWR	Input VSWR	f = 0.1 to 1.5 GHz		1.9:1	
	Output VSWR	f = 0.1 to 1.5 GHz		1.8:1	
NF	50 Ω Noise Figure	f = 0.5 GHz		2.8	
P _{1dB}	Output Power at 1 dB Gain Compression	f = 0.5 GHz		2.0	
IP ₃	Third Order Intercept Point	f = 0.5 GHz		14.5	
t _D	Group Delay	f = 0.5 GHz		200	
V _d	Device Voltage		3.1	3.5	3.9
dV/dT	Device Voltage Temperature Coefficient			-8.0	

Notes:

1. The recommended operating current range for this device is 12 to 30 mA. Typical performance as a function of current is on the following page.
2. RF performance of the chip is determined by packaging and testing 10 devices per wafer in a dual ground configuration.

Part Number Ordering Information

Part Number	Devices Per Tray
MSA-0600-GP4	100

MSA-0600 Typical Scattering Parameters[1] ($Z_0 = 50 \Omega$, $T_A = 25^\circ\text{C}$, $I_d = 16 \text{ mA}$)

Freq. GHz	S_{11}		S_{21}			S_{12}			S_{22}		k
	Mag	Ang	dB	Mag	Ang	dB	Mag	Ang	Mag	Ang	
0.1	.05	-148	20.6	10.66	173	-23.3	.068	4	.05	-67	1.05
0.2	.07	-134	20.4	10.48	166	-23.1	.070	8	.09	-91	1.04
0.3	.09	-125	20.2	10.28	159	-22.6	.074	13	.13	-102	1.01
0.4	.11	-121	20.0	10.01	151	-22.4	.076	15	.16	-110	1.00
0.5	.13	-120	19.7	9.71	145	-22.1	.078	17	.20	-117	0.98
0.6	.15	-119	19.4	9.34	140	-21.8	.081	20	.22	-124	0.97
0.8	.19	-121	18.7	8.60	123	-20.7	.092	25	.25	-136	0.93
1.0	.25	-123	17.9	7.82	117	-19.8	.102	26	.28	-148	0.90
1.5	.32	-134	15.7	6.10	96	-18.3	.122	29	.29	-168	0.89
2.0	.40	-149	13.5	4.73	79	-17.4	.136	27	.26	175	0.91
2.5	.45	-157	11.6	3.79	70	-16.9	.142	30	.23	169	0.97
3.0	.49	-171	9.9	3.12	61	-16.6	.148	28	.19	168	1.03
3.5	.51	-174	8.3	2.60	51	-16.4	.152	25	.16	173	1.10
4.0	.51	179	6.9	2.21	43	-16.3	.153	26	.12	-170	1.22
4.5	.51	170	5.7	1.93	37	-16.0	.159	24	.10	-149	1.31
5.0	.51	162	4.7	1.71	29	-15.9	.161	24	.11	-126	1.41

Note:

- S-parameters are de-embedded from 70 mil package measured data using the package model found in the DEVICE MODELS section.

Typical Performance, $T_A = 25^\circ\text{C}$
(unless otherwise noted)

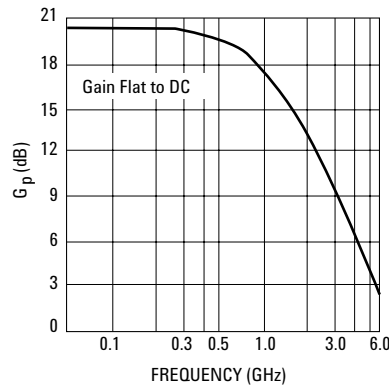

Figure 1. Typical Power Gain vs. Frequency, $T_A = 25^\circ\text{C}$, $I_d = 16 \text{ mA}$.

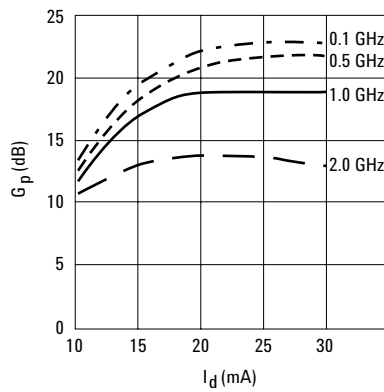

Figure 2. Power Gain vs. Current.

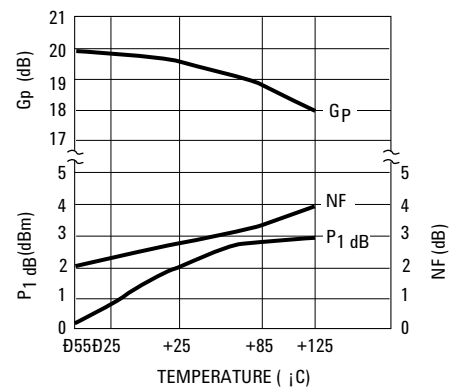

Figure 3. Output Power at 1 dB Gain Compression, NF and Power Gain vs. Mounting Surface Temperature, $f = 0.5 \text{ GHz}$, $I_d = 16 \text{ mA}$.

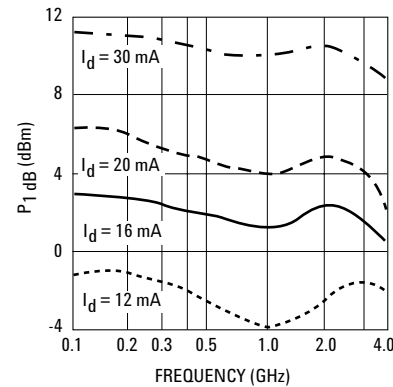

Figure 4. Output Power at 1 dB Gain Compression vs. Frequency.

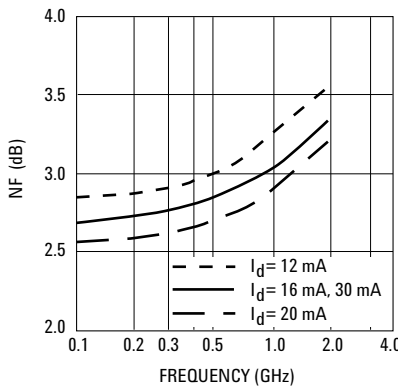
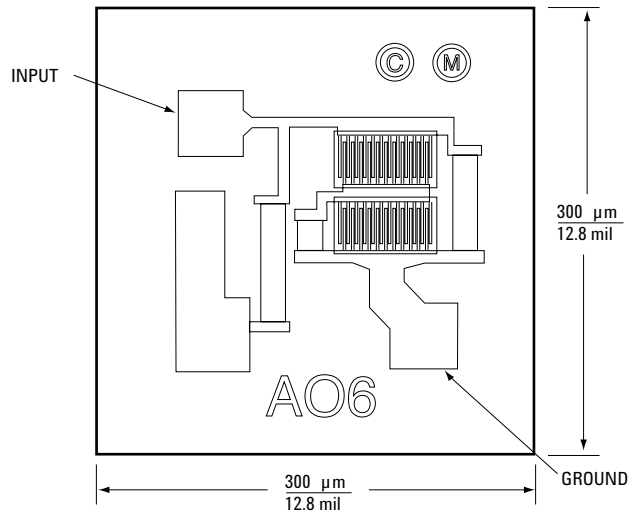

Figure 5. Noise Figure vs. Frequency.

MSA-0600 Chip Dimensions



For product information and a complete list of distributors, please go to our web site:

www.avagotech.com

Avago, Avago Technologies, and the A logo are trademarks of Avago Technologies, Pte. in the United States and other countries. Data subject to change. Copyright © 2006 Avago Technologies Pte. All rights reserved. AV01-0025EN - November 2, 2007

AVAGO
TECHNOLOGIES