



DCM™ in a VIA Package DC-DC Converter DCM3414x50M13C2yzz



Isolated, Regulated DC Converter

Features & Benefits

- Isolated, regulated DC-to-DC converter
- Up to 320 W, 26.67 A continuous
- 91.7% peak efficiency
- 183 W/in³ Power density
- Wide input range 16 – 50 Vdc
- Safety Extra Low Voltage (SELV) 12.0 V Nominal Output
- ZVS high frequency switching
- Allows remote sense or local sense operation
- Tight regulation over all line and load conditions
- Fully operational current limit
- OV, OC, UV, short circuit and thermal protection
- Available in chassis mount and through hole VIA package
 - 3.380" x 1.400" x 0.370"
(85.93 mm x 35.5 mm x 9.40 mm)

Product Ratings	
$V_{IN} = 16\text{ V to }50\text{ V}$	$P_{OUT} = 320\text{ W}$
$V_{OUT} = 12.0\text{ V}$ (7.2 V to 13.2 V Trim)	$I_{OUT} = 26.67\text{ A}$

Product Description

The DCM in a VIA package is an Isolated, Regulated DC-to-DC Converter, operating from an unregulated, wide range input to generate an isolated 12.0 Vdc output. With its high frequency zero voltage switching (ZVS) topology, the DCM converter consistently delivers high efficiency across the input line range. The DCM provides tight output voltage regulation and offers a secondary-referenced control interface for trim, enable, and remote sense operation. DCM converters and downstream DC-DC products support efficient power distribution, providing superior power system performance and connectivity from a variety of unregulated power sources to the point-of-load. The VIA package offers flexible thermal management options with very low top and bottom side thermal impedances.

Typical Applications

- Industrial
- Process Control
- Heavy Equipment
- Defense / Aerospace

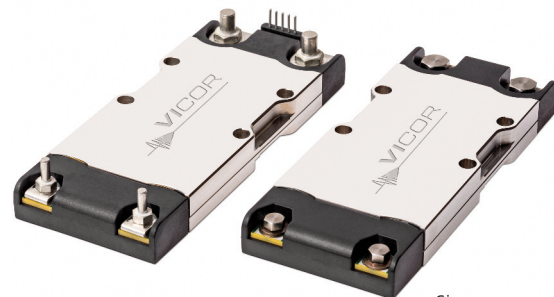

Size:
3.380 x 1.400 x 0.370 in
85.93 x 35.5 x 9.40 mm

Part Ordering Information

Product Function	Package Length	Package Width	Package Type	Max Input Voltage	Range Ratio	Max Output Voltage	Max Output Power	Product Grade (Case Temperature)	Option Field	
DCM	34	14	x	50	M	13	C2	y	z	z
DCM = DC-DC Converter	Length in Inches x 10	Width in Inches x 10	B = Board VIA V = Chassis VIA	Internal Reference				C = -20 to 100°C ^[1] T = -40 to 100°C ^[1] M = -55 to 100°C ^{[1][2]}	01 = Chassis/Analog 05 = Short Pin/Analog 09 = Long Pin/Analog	

^[1] High Temperature Power Derating may apply, see Thermal Specified Operating Area, Figure 1 on Page 4.

^[2] M-Grade available on selected models. Consult vicorpower.com for details.

Typical Application

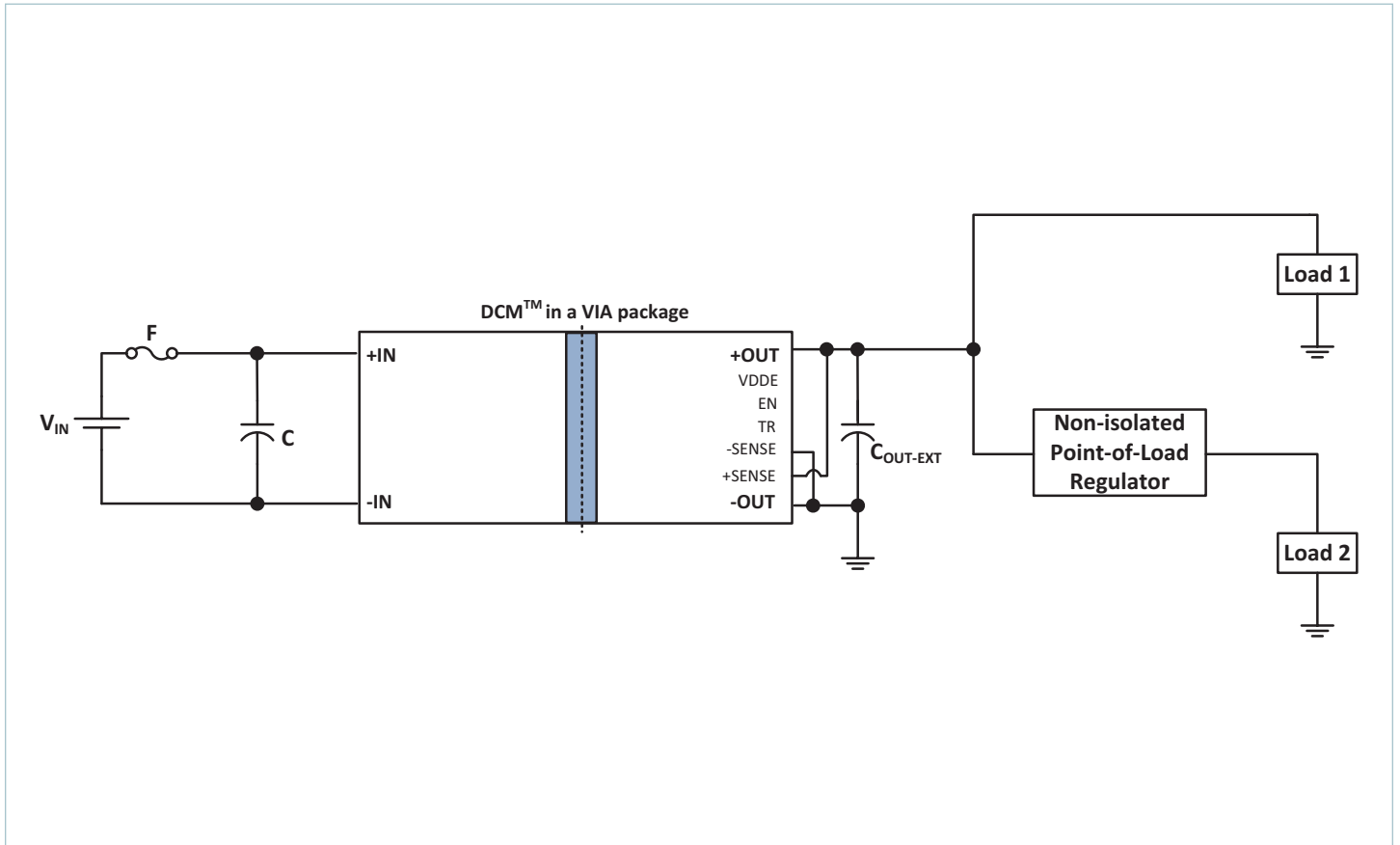

Typical Application: Single DCM3414x50M13C2yzz in Local Sense Operation, to a non-isolated regulator, and direct to load

Pin Configuration

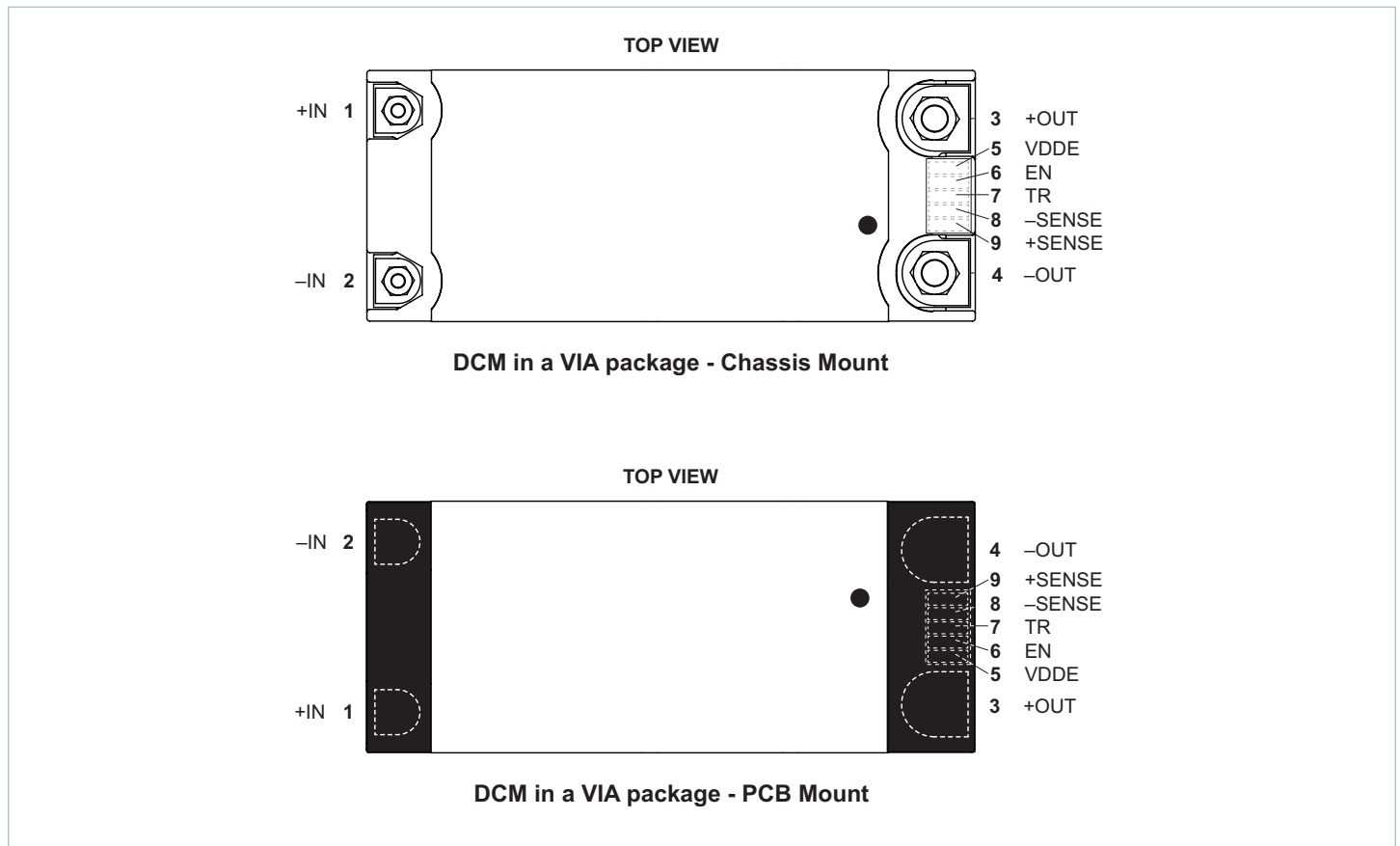

Note: The dot on the VIA housing indicates the location of the control pin 9 (+SENSE pin).

Pin Descriptions

Pin Number	Signal Name	Type	Function
1	+IN	INPUT POWER	Positive input power terminal
2	-IN	INPUT POWER RETURN	Negative input power terminal
3	+OUT	OUTPUT POWER	Positive output power terminal
4	-OUT	OUTPUT POWER RETURN	Negative output power terminal
5	VDDE	POWER INPUT	External power supply for internal controller
6	EN	CONTROL INPUT	Enables and disables DCM. Needs VDDE preapplied
7	TR	CONTROL INPUT	Enables and disables trim functionality. Adjusts output voltage when trim active.
8	-SENSE	CONTROL INPUT	Negative sense pin, required for Remote Sense Operation. In Local Sense Operation, it can be tied directly to -OUT to achieve better regulation accuracy.
9	+SENSE	CONTROL INPUT	Positive sense pin, required for Remote Sense Operation. In Local Sense Operation, it can be tied directly to +OUT to achieve better regulation accuracy.

Note: All control inputs (EN, TR, -SENSE, +SENSE) are referenced to the secondary of the DCM and isolated from the primary.

Absolute Maximum Ratings

The absolute maximum ratings below are stress ratings only. Operation at or beyond these maximum ratings can cause permanent damage to the device. Electrical specifications do not apply when operating beyond rated operating conditions.

Parameter	Comments	Min	Max	Unit
Input Voltage (+IN to -IN)	C Grade, T Grade	-0.5	65	V
Input Voltage (+IN to -IN)*	M Grade (continuous absolute maximum input voltage)**	-0.5	52	V
Input Voltage Slew Rate			1	V/μs
TR to -OUT		-0.5	3.6	V
EN to -OUT		-0.5	3.6	V
VDDE to -OUT		0	12	V
-SENSE to -OUT		0	2.225	V
+OUT to +SENSE		0	2.225	V
+SENSE to -OUT		0	15.6	V
Output Voltage (+Out to -Out)		-0.5	16.3	V
Dielectric withstand (input to output)		1500		Vdc
Internal Operating Temperature	C Grade	-20	125	°C
	T Grade	-40	125	°C
	M Grade	-55	125	°C
Storage Temperature	C Grade	-20	125	°C
	T Grade	-40	125	°C
	M Grade	-65	125	°C
Average Output Current			26.7	A

* LVMMF + 16 – 50 V input range products guarantees MIL-STD 461E/F & MIL-STD 1275 D/E.

** Applicable only for 16 – 50 V input range products.

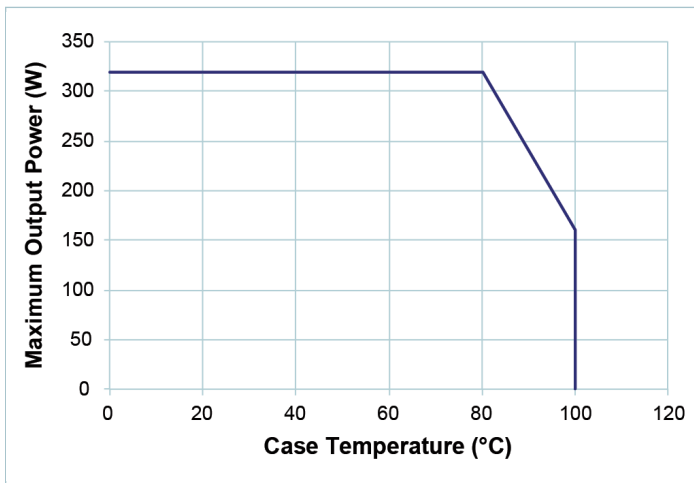

Figure 1 — Thermal Specified Operating Area: Max Output Power vs. Case Temp, Single unit at minimum full load efficiency

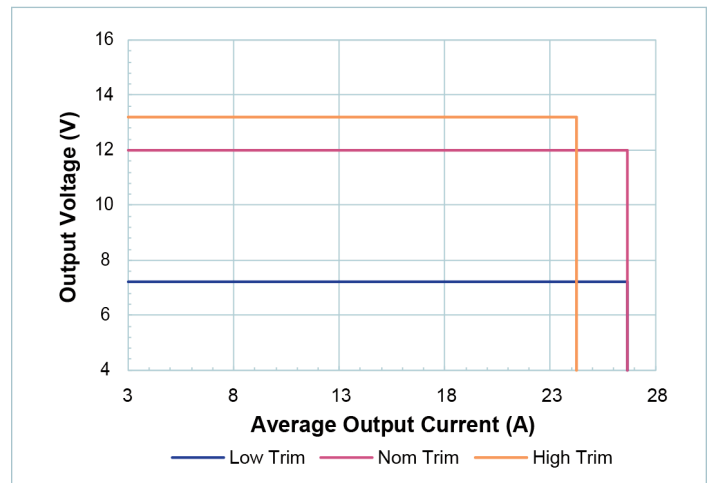

Figure 2 — Electrical Specified Operating Area

Electrical Specifications

Specifications apply over all line, trim and load conditions, internal temperature $T_{INT} = 25^{\circ}\text{C}$, unless otherwise noted. **Boldface** specifications apply over the temperature range specified by the product grade.

Attribute	Symbol	Conditions / Notes	Min	Typ	Max	Unit
Power Input Specification						
Input voltage range	V_{IN}	Continuous operation	16	28	50	V
Inrush current (peak)	I_{INRP}	With maximum C_{OUTEXT} , full resistive load			30.0	A
Input capacitance (internal)	C_{IN-INT}	Effective value at nominal input voltage		42.0		μF
Input capacitance (internal) ESR	$R_{CIN-INT}$	At 1 MHz		0.73		$\text{m}\Omega$
Input inductance (external)	L_{IN}	Differential mode, with no further line bypassing			1	μH
No Load Specification						
Input power – disabled	P_Q	Nominal line, see Fig. 3		0.5	0.7	W
		Worst case line, see Fig. 3			0.8	W
Input power – enabled with no load	P_{NL}	Nominal line, see Fig. 4		1.5	5.0	W
		Worst case line, see Fig. 4			7.0	W
Power Output Specification						
Output voltage set point	V_{OUTNOM}		11.94	12.0	12.06	V
Rated output voltage trim range	$V_{OUTTRIMMING}$	Trim range over temp. Specifies the Low, Nominal and High Trim conditions.	7.2	12.0	13.2	V
V_{OUT} accuracy	$\%V_{OUT}$ ACCURACY	Total output voltage setpoint accuracy for all line conditions and for all load conditions above 10% of rated load, with trim inactive and SENSE pins connected (either at the load for remote sense, or at the DCM output for local sense)			0.5	%
V_{OUT} accuracy with Sense Pins floating	$\%V_{OUT}$ ACCURACY-SF	Total output voltage setpoint accuracy for all line conditions and for all load conditions above 10% of rated load, with trim inactive and Sense Pins floating (Local Sense only)			1.0	%
V_{OUT} accuracy with trim active	$\%V_{OUT}$ ACCURACY-TRIM	Total output voltage setpoint accuracy for all line conditions and for all load conditions above 10% of rated load, with trim active			2.0	%
V_{OUT} accuracy light load	$\%V_{OUT}$ ACCURACY-LL	Total output voltage setpoint accuracy for all line and trim conditions, for load conditions below or equal to 10% of rated load			5.0	%
Rated output power	P_{OUT}	Continuous, $V_{OUT} \geq 12.0\text{ V}$	320			W
Rated output current	I_{OUT}	Continuous, $V_{OUT} \leq 12.0\text{ V}$	26.67			A
Output current limit	$I_{OUT-LIM}$	Of rated I_{OUT} max. Fully operational current limit, for nominal trim and below	103	115	135	%
Current limit delay	$t_{IOUT-LIM}$	The module will power limit in a fast transient event		1		ms
Efficiency	η	Full load, nominal line, nominal trim	90.3	91.5		%
		Full load, over line and temperature, nominal trim	87.0			%
		50% load, over rated line, temperature and trim	85.0			%
Output voltage ripple	V_{OUT-PP}	Over all operating steady-state line, load and trim conditions, 20 MHz BW, with minimum C_{OUTEXT}		180		mV
Output capacitance (internal)	$C_{OUT-INT}$	Effective value at nominal output voltage		201		μF
Output capacitance (internal) ESR	$R_{COUT-INT}$	At 1 MHz		0.07		$\text{m}\Omega$

Electrical Specifications (cont.)

Specifications apply over all line, trim and load conditions, internal temperature $T_{INT} = 25^{\circ}\text{C}$, unless otherwise noted. **Boldface** specifications apply over the temperature range specified by the product grade.

Attribute	Symbol	Conditions / Notes	Min	Typ	Max	Unit
Power Output Specifications (Cont.)						
Output capacitance (external)	$C_{OUT-EXT}$	Excludes component temperature coefficient. For load transients that remain > 2% rated load	1000		10000	μF
Output capacitance (external)	$C_{OUT-EXT-TRANSIENT}$	Excludes component temperature coefficient. For load transients down to 0% rated load	10000		10000	μF
Output capacitance, ESR (ext.)	$R_{COUT-EXT}$	At 10 kHz, excludes component tolerances	10			$\text{m}\Omega$
Initialization delay	t_{INIT}	See state diagram		25	40	ms
Output turn-on delay	t_{ON}	From rising edge EN, with VDDE pre-applied. See timing diagram		200		μs
Output turn-off delay	t_{OFF}	From falling edge EN. See timing diagram			600	μs
Soft start ramp time	t_{SS}	Full load (soft-start ramp time) with minimum $C_{OUT-EXT}$		300		ms
V_{OUT} threshold for max rated load current	$V_{OUTFL-THRESH}$	During startup, V_{OUT} must achieve this threshold before output can support full rated current			6.0	V
I_{OUT} at startup	$I_{OUT-START}$	Max load current at startup while V_{OUT} is below $V_{OUTFL-THRESH}$	2.66			A
Monotonic soft-start threshold voltage	$V_{OUT-MONOTONIC}$	Output voltage rise becomes monotonic with 1% of preload once it crosses $V_{OUT-MONOTONIC}$			6.0	V
Minimum required disabled duration	$t_{OFF-MIN}$	This refers to the minimum time a module needs to be in the disabled state before it will attempt to start via EN			2	ms
Minimum required disabled duration for predictable restart	$t_{OFF-MONOTONIC}$	This refers to the minimum time a module needs to be in the disabled state before it is guaranteed to exhibit monotonic soft-start and have predictable startup timing			100	ms
Voltage deviation (transient)	$\%V_{OUT-TRANS}$	Minimum $C_{OUT-EXT}$ (10 \leftrightarrow 90% load step)		<10		%
Settling time	t_{SETTLE}			2.0		ms
Powertrain Protections						
Input Voltage Initialization threshold	$V_{IN-INIT}$	Threshold to start t_{INIT} delay			6.0	V
Input Voltage Reset threshold	$V_{IN-RESET}$	Latching faults will clear once V_{IN} falls below $V_{IN-RESET}$	3.0			V
Input undervoltage lockout threshold	$V_{IN-UVLO-}$		12.0		14.0	V
Input undervoltage recovery threshold	$V_{IN-UVLO+}$	See Timing diagram			16.0	V
Input overvoltage lockout threshold*	$V_{IN-OVLO+}$				55.0	V
Input overvoltage recovery threshold*	$V_{IN-OVLO-}$	See Timing diagram	50.0			V
Output overvoltage threshold	$V_{OUT-OVP}$	Latched shutdown	15.6			V
Minimum current limited V_{OUT}	$V_{OUT-LVP}$	Over all operating steady-state line and trim conditions			4.2	V
Overtemperature threshold (internal)	$T_{INT-OTP}$		130.0			$^{\circ}\text{C}$
Power limit	P_{LIM}				630.0	W
V_{IN} overvoltage to cessation of powertrain switching	$t_{OVLO-SW}$	Independent of fault logic		1.5		μs
V_{IN} overvoltage response time	t_{OVLO}	For fault logic only			200	μs
V_{IN} undervoltage response time	t_{UVLO}				100	ms
Short circuit response time	t_{SC}	Powertrain on, operational state			200	μs
Short circuit, or temperature fault recovery time	t_{FAULT}	See Timing diagram		1		s

* Input OVLO protection specifications do not apply for 16 – 50 V input range M Grade products.

Signal Specifications

Specifications apply over all line, trim and load conditions, internal temperature $T_{INT} = 25^{\circ}\text{C}$, unless otherwise noted. **Boldface** specifications apply over the temperature range specified by the product grade. **Please note:** For chassis mount models, Vicor part number 42550 will be needed for applications requiring the use of signal pins (Enable, Trim and Sense functions).^[2]

Enable: EN								
<ul style="list-style-type: none"> The EN pin enables and disables the DCM; when held low the unit will be disabled. The EN pin is activated only if VDDE is preapplied before V_{IN} is applied. Otherwise, EN is inactive and will be ignored until V_{IN} is removed and reapplied. Additionally, if VDDE is removed at any time, EN will return to inactive mode. The EN pin is referred to the –OUT of the converter and isolated from the primary side 								
SIGNAL TYPE	STATE	ATTRIBUTE	SYMBOL	CONDITIONS / NOTES	MIN	NOM	MAX	UNIT
DIGITAL INPUT	Any	EN enable threshold	$V_{ENABLE-EN}$				2.31	V
		EN disable threshold	$V_{ENABLE-DIS}$	Needs VDDE preapplied	0.99			V
		Internally generated V_{CC}	V_{CC}		3.23	3.30	3.37	V
		EN internal pull up resistance to V_{CC}	$R_{ENABLE-INT}$		0.990	1.000	1.010	k Ω

Trim: TR								
<ul style="list-style-type: none"> The TR pin enables and disables trim functionality when V_{IN} is initially applied to the DCM converter. When V_{in} first crosses $V_{IN-UVLO+}$, the voltage on TR determines whether or not trim is active. If TR is not floating at power up and has a voltage less than TR trim enable threshold, trim is active. If trim is active, the TR pin provides dynamic trim control with at least 250 Hz of -3dB control bandwidth over the output voltage of the DCM converter. The TR pin has an internal pull-up to V_{CC} and is referenced to the –OUT pin of the converter. $V_{TRIM-RANGE}$ represents the trim pin functional limits only. Module performance is guaranteed within rated output voltage trim range $V_{OUT-TRIMMING}$, see electrical specification on page 5. 								
SIGNAL TYPE	STATE	ATTRIBUTE	SYMBOL	CONDITIONS / NOTES	MIN	NOM	MAX	UNIT
DIGITAL INPUT	Startup	TR trim disable threshold	$V_{TRIM-DIS}$	Trim disabled when TR above this threshold at power up			3.20	V
		TR trim enable threshold	$V_{TRIM-EN}$	Trim enabled when TR below this threshold at power up	3.10			V
ANALOG INPUT	Operational with Trim enabled	Internally generated V_{CC}	V_{CC}		3.23	3.30	3.37	V
		TR pin functional range	$V_{TRIM-RANGE}$	Functional limits only	0.00	2.37	3.10	V
		V_{OUT} referred TR pin resolution	$V_{OUT-RES}$	With $V_{CC} = 3.3\text{ V}$		8.79		mV
		TR internal pull up resistance to V_{CC}	$R_{TRIM-INT}$		0.999	1.000	1.001	k Ω

VDDE								
<ul style="list-style-type: none"> VDDE powers the internal controller. VDDE needs to be preapplied before V_{IN} in order to activate EN functionalities. If not preapplied, VDDE is derived from V_{OUT}; however, in this case, the enable function is not activated (the unit is always enabled and can be disabled only by removing V_{IN}.) If VDDE is removed during operation, the unit will return in "always enabled" mode, ignoring the EN pin until VDDE is reapplied and V_{IN} is cycled. 								
SIGNAL TYPE	STATE	ATTRIBUTE	SYMBOL	CONDITIONS / NOTES	MIN	NOM	MAX	UNIT
POWER INPUT	Any	Power input for internal controller	VDDE		4	5	10	V
		VDDE current consumption	I_{VDDE}			35	50	mA

^[2] Signal cable 42550 is rated for up to 5 insertions and extractions. To avoid unnecessary stress on the connector, the cable should be tied to the chassis.

Signal Specifications (Cont.)

Specifications apply over all line, trim and load conditions, internal temperature $T_{INT} = 25^{\circ}C$, unless otherwise noted. **Boldface** specifications apply over the temperature range specified by the product grade. **Please note:** For chassis mount models, Vicor part number 42550 will be needed for applications requiring the use of signal pins (Enable, Trim and Sense functions).

+SENSE, -SENSE

- Provide Remote Sense capability.
- If floating, the DCM automatically implements Local Sense Operation. To achieve maximum regulation accuracy in local sense, the SENSE pins should be connected directly to their respective OUT pins. If SENSE pins are floating, the regulation accuracy degrades (see "V_{OUT} accuracy with Sense Pins floating" on Page 5).

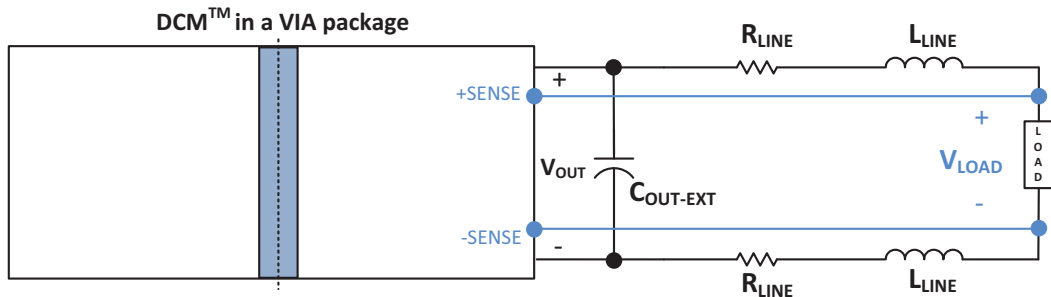

- Module performance is guaranteed for $\Delta V_{OUT_TO_LOAD}$ within rated limits specified below. For $\Delta V_{OUT_TO_LOAD}$ higher than the specified limits, regulation accuracy is not guaranteed. Also, high $\Delta V_{OUT_TO_LOAD}$ might trigger OVP (for above nominal trim conditions), and might cause load voltage runaway (which might trigger UVP).

ATTRIBUTE	SYMBOL	CONDITIONS / NOTES	MIN	NOM	MAX	UNIT
Remote Sense rated Voltage Drop	$\Delta V_{OUT_TO_LOAD}$	Rated voltage drop between DCM package output and sense point at the load, in Remote Sense Operation. Module performance is guaranteed for $\Delta V_{OUT_TO_LOAD}$ below this threshold.			120	mV

Timing Diagrams (Cont.)

Module Inputs are shown in blue; Module Outputs are shown in brown. Timing diagrams assume VDDE pre-applied. Without VDDE pre-applied, EN is ignored, EN and Trim will go high after V_{OUT} . All other behaviors (OVLO, UVLO, OVP, etc.) will remain the same.

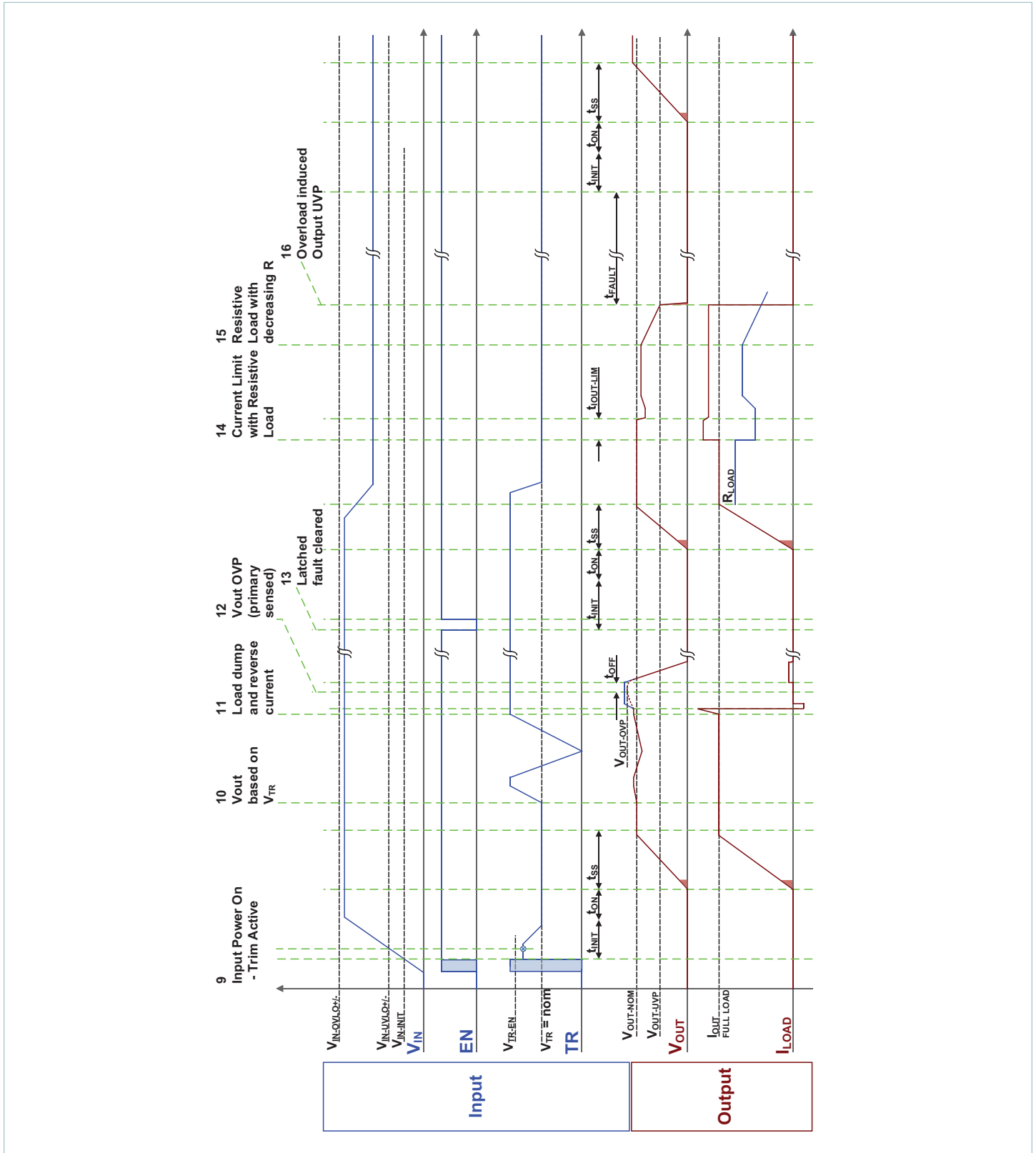

Typical Performance Characteristics

The following figures present typical performance at $T_C = 25^\circ\text{C}$, unless otherwise noted. See associated figures for general trend data.

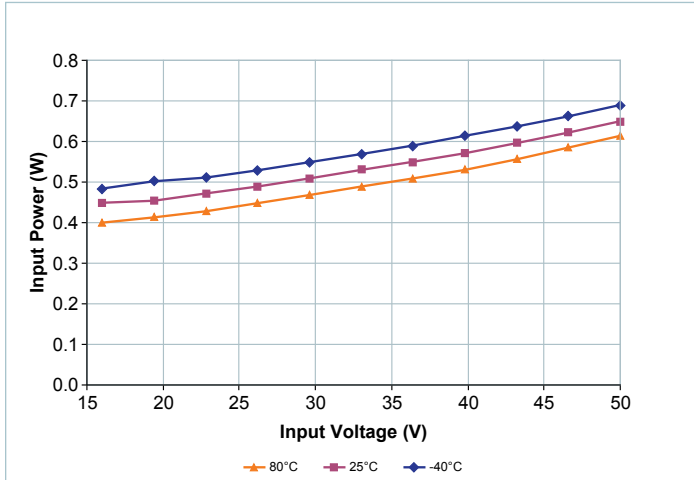

Figure 3 — Disabled power dissipation vs. V_{IN}

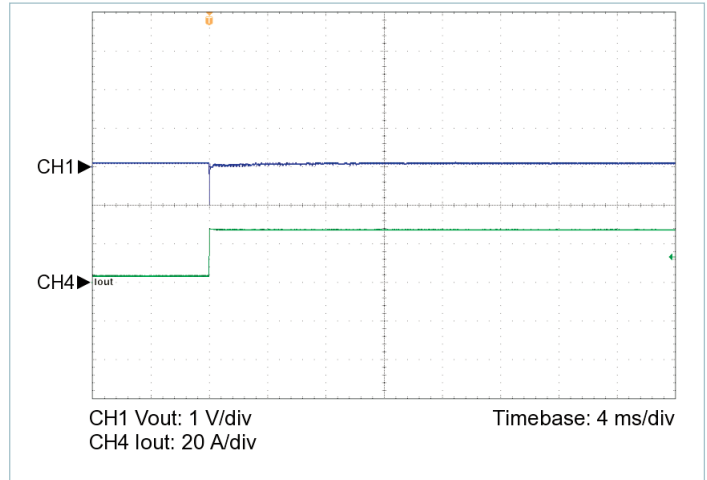

Figure 6 — 10% to 100% load transient response, $V_{IN} = 28\text{ V}$, nominal trim, $C_{OUT_EXT} = 1000\ \mu\text{F}$

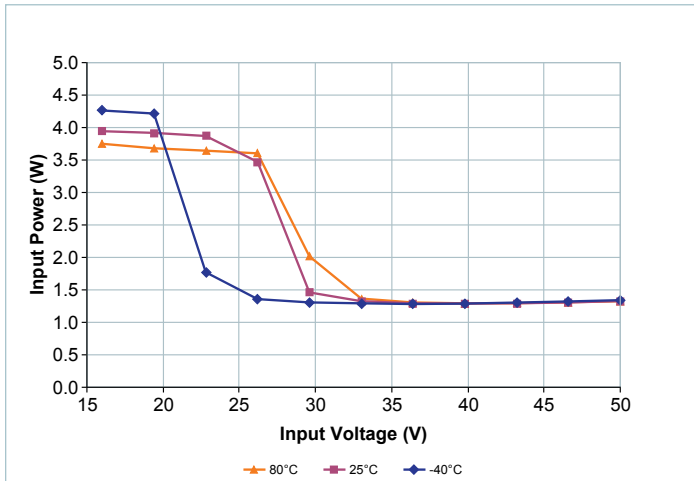

Figure 4 — No load power dissipation vs. V_{IN} at nominal trim

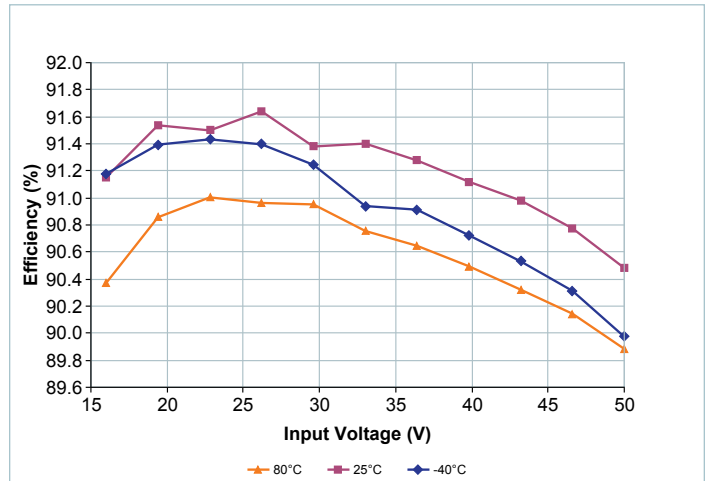

Figure 7 — Full Load Efficiency vs. V_{IN} at low trim

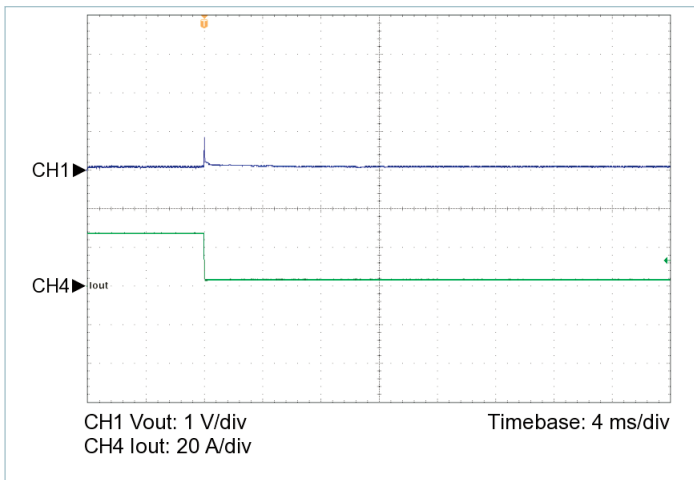

Figure 5 — 100% to 10% load transient response, $V_{IN} = 28\text{ V}$, nominal trim, $C_{OUT_EXT} = 1000\ \mu\text{F}$

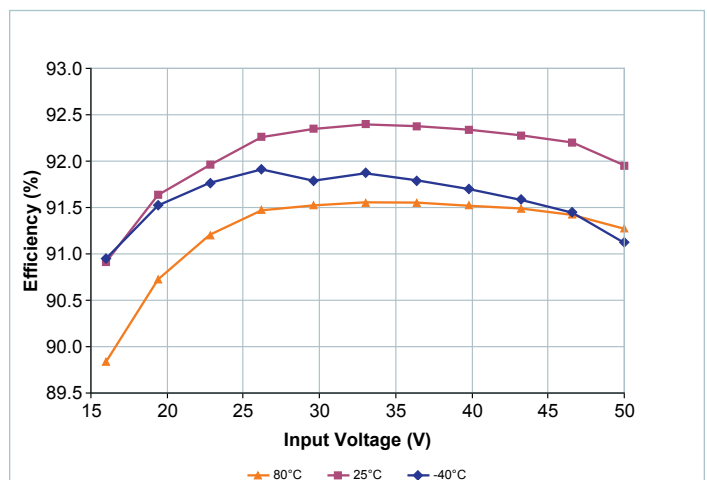

Figure 8 — Full Load Efficiency vs. V_{IN} at nominal trim

Typical Performance Characteristics (cont.)

The following figures present typical performance at $T_C = 25^\circ\text{C}$, unless otherwise noted. See associated figures for general trend data.

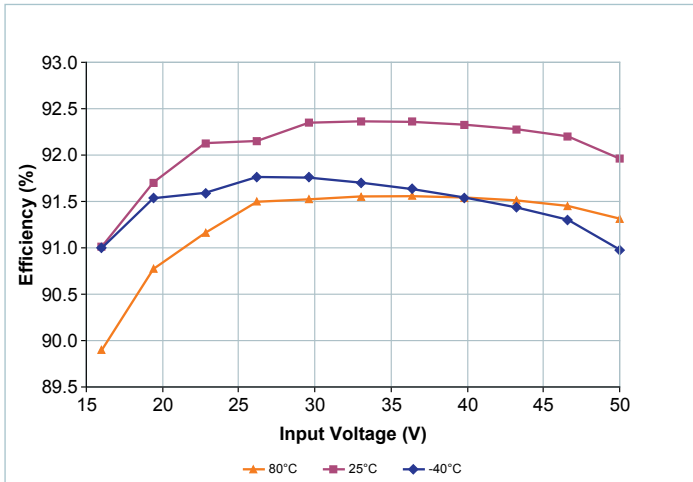

Figure 9 — Full Load Efficiency vs. V_{IN} at high trim

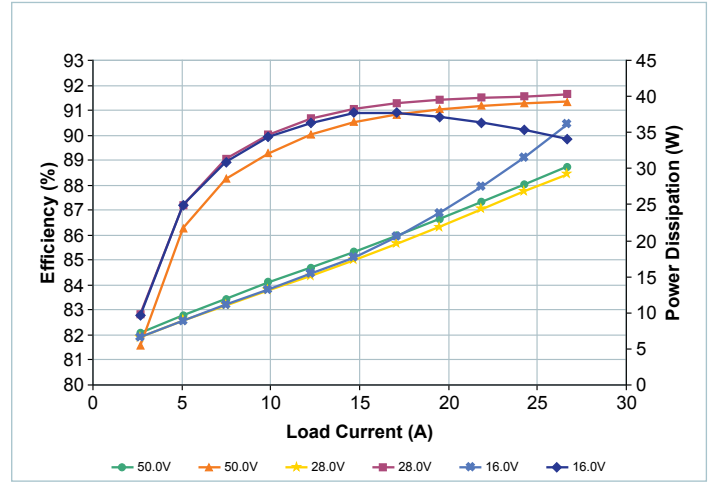

Figure 12 — Efficiency (top three curves) and power dissipation (bottom three curves) vs. load at $T_{CASE} = 80^\circ\text{C}$, nominal trim

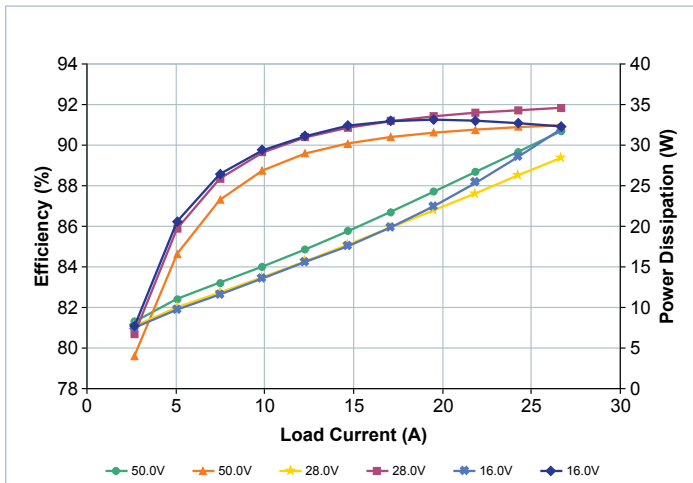

Figure 10 — Efficiency (top three curves) and power dissipation (bottom three curves) vs. load at $T_{CASE} = -40^\circ\text{C}$, nominal trim

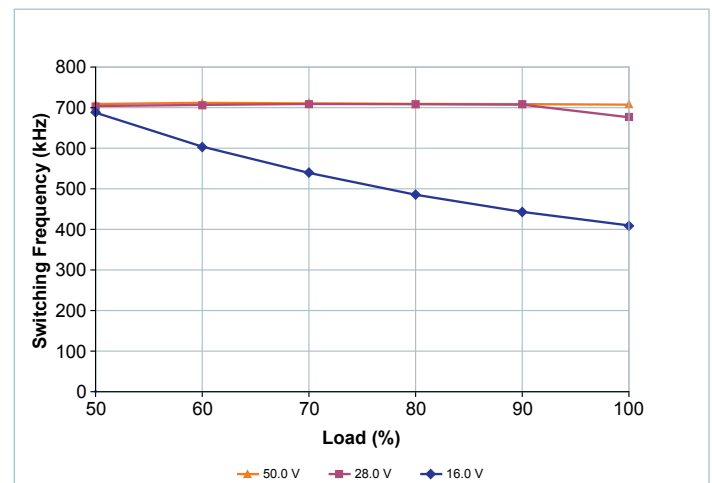

Figure 13 — Nominal powertrain switching frequency vs. load, at nominal trim

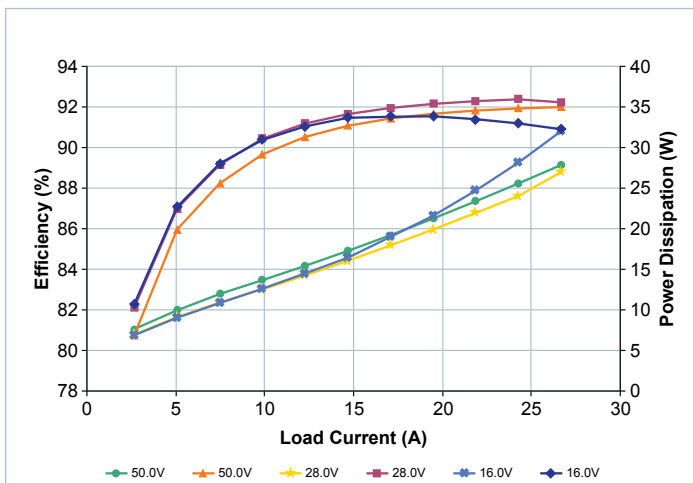

Figure 11 — Efficiency (top three curves) and power dissipation (bottom three curves) vs. load at $T_{CASE} = 25^\circ\text{C}$, nominal trim

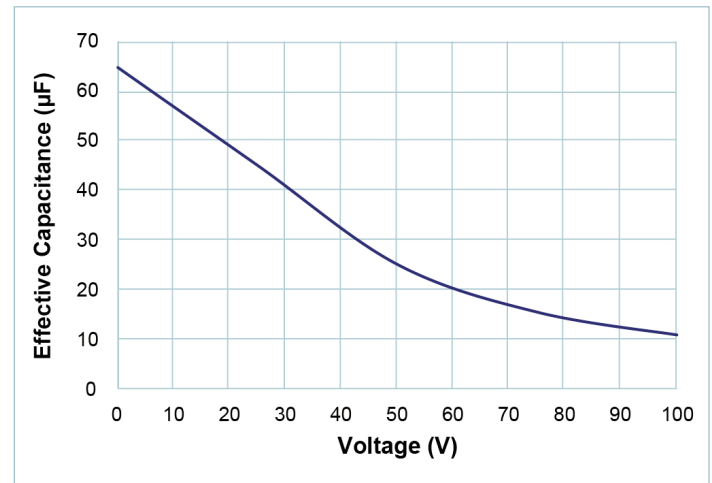

Figure 14 — Effective internal input capacitance vs. applied voltage

Typical Performance Characteristics (cont.)

The following figures present typical performance at $T_C = 25^\circ\text{C}$, unless otherwise noted. See associated figures for general trend data.

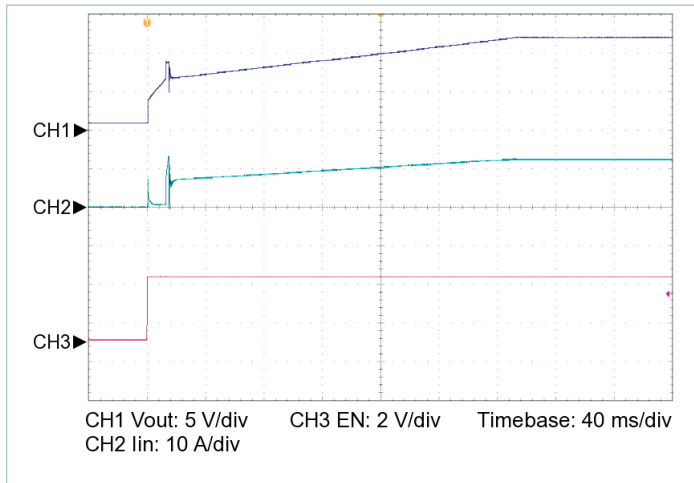

Figure 15 — Startup from EN, $V_{IN} = 28\text{ V}$, $C_{OUT_EXT} = 10000\ \mu\text{F}$,
 $R_{LOAD} = 0.450\ \Omega$

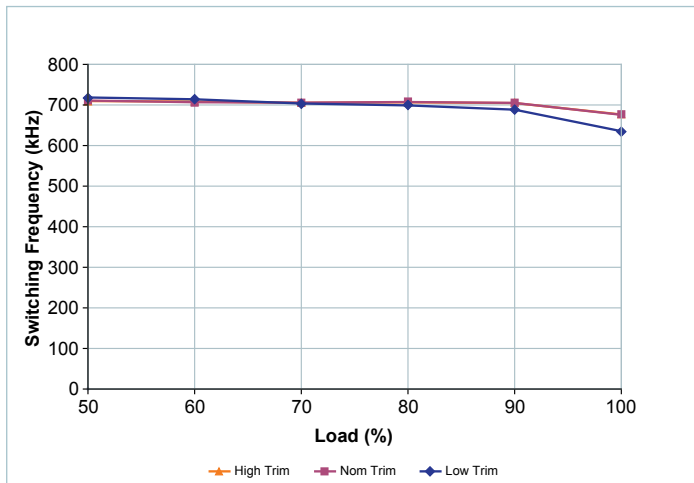

Figure 16 — Nominal powertrain switching frequency vs. load, at nominal V_{IN}

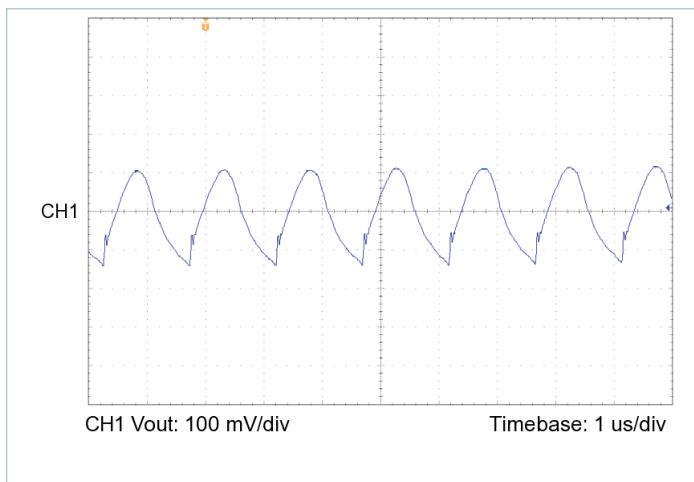

Figure 17 — Output voltage ripple, $V_{IN} = 28\text{ V}$,
 $V_{OUT} = 12.0\text{ V}$, $C_{OUT_EXT} = 1000\ \mu\text{F}$, $R_{LOAD} = 0.450\ \Omega$

General Characteristics

Specifications apply over all line, trim and load conditions, internal temperature $T_{INT} = 25^{\circ}\text{C}$, unless otherwise noted. **Boldface** specifications apply over the temperature range specified by the product grade.

Attribute	Symbol	Conditions / Notes	Min	Typ	Max	Unit
Mechanical ^[3]						
Length	L		85.68/[3.37]	85.93/[3.38]	86.18/[3.3900]	mm/[in]
Width	W		35.29/[1.39]	35.54/[1.4]	35.79/[1.41]	mm/[in]
Height	H		9.02/[0.355]	9.4/[0.37]	9.78/[0.385]	mm/[in]
Volume	Vol	No heat sink		28.40/[1.75]		cm ³ /[in ³]
Weight	W			101.0/[3.56]		g/[oz]
Pin Material		C145 copper				
Underplate		Low stress ductile Nickel	50		100	μin
Pin Finish (Gold)		Palladium	0.8		6	μin
		Soft Gold	0.12		2	
Pin Finish (Tin)		Whisker resistant matte Tin	200		400	μin
Thermal						
Operating internal temperature ^[5]	T_{INT}	C-Grade	-20		125	°C
		T-Grade	-40		125	°C
		M-Grade	-55		125	°C
Thermal resistance top side	θ_{INT_TOP}	Estimated thermal resistance to maximum temperature internal component from isothermal top housing		1.31		°C/W
Thermal resistance housing	θ_{HOU}	Estimated thermal resistance from top housing to bottom housing		0.55		°C/W
Thermal resistance bottom side	θ_{INT_BOT}	Estimated thermal resistance to maximum temperature internal component from isothermal bottom housing		2.33		°C/W
Thermal capacity				35.0		Ws/°C
Assembly						
Storage temperature	T_{ST}	C-Grade	-20		125	°C
		T-Grade	-40		125	°C
		M-Grade	-65		125	°C
ESD rating	HBM	Method per Human Body Model Test ESDA/JEDEC JDS-001-2012	CLASS 1C			V
	CDM	Charged Device Model JESD22-C101E	CLASS 2			
Soldering ^[4]						
Peak temperature top case		For further information, please contact factory applications			130	°C

^[3] Product appearance may change over time depending upon environmental exposure. This change has no impact on product performance.

^[4] Product is not intended for reflow solder attach.

^[5] Temperature refers to the internal operation of the DCM VIA. For maximum case temperature, please refer to figure 1.

General Characteristics (Cont.)

Specifications apply over all line, trim and load conditions, internal temperature $T_{INT} = 25^{\circ}\text{C}$, unless otherwise noted. **Boldface** specifications apply over the temperature range specified by the product grade.

Attribute	Symbol	Conditions / Notes	Min	Typ	Max	Unit
Safety						
Dielectric Withstand Test	V_{HIPO}	IN to OUT	1500			Vdc
		IN to CASE	1500			Vdc
		OUT to CASE	707			Vdc
Reliability						
MTBF		MIL-HDBK-217Plus Parts Count - 25°C Ground Benign, Stationary, Indoors / Compute		1.70		MHrs
		Telcordia Issue 2 - Method I Case III; 25°C Ground Benign, Controlled		2.20		MHrs
Agency Approvals						
Agency approvals/standards		cTÜVus, EN 60950-1				
		cURus, UL 60950-1				
		CE Marked for Low Voltage Directive and RoHS Recast Directive, as applicable				

Pin Functions

+IN, -IN

Input power pins.

+OUT, -OUT

Output power pins. –Out also serves as reference for the secondary-referenced control pins.

EN (Enable)

This pin enables and disables the DCM converter; when held low the unit will be disabled. It is referenced to the -OUT pin of the converter. EN is active only if VDDE is preapplied before V_{IN} is applied. Otherwise, EN is inactive and will be ignored until V_{IN} is removed and reapplied.

- Output enable: When EN is allowed to pull up above the enable threshold, the module will be enabled. If leaving EN floating, it is pulled up to V_{CC} and the module will be enabled.
- Output disable: EN may be pulled down externally in order to disable the module.
- EN is an input only, it does not pull low in the event of a fault.

TR (Trim)

The TR pin is used to select the trim mode and to trim the output voltage of the DCM converter. The TR pin has an internal pull-up to V_{CC} .

The DCM package will latch trim behavior at application of V_{IN} (once V_{IN} exceeds $V_{IN-UVLO+}$), and persist in that same behavior until loss of input voltage.

- At application of V_{IN} , if TR is sampled at above $V_{TRIM-DIS}$, the module will latch in a non-trim mode, and will ignore the TR input for as long as V_{IN} is present.
- At application of V_{IN} , if TR is sampled at below $V_{TRIM-EN}$, the TR will serve as an input to control the real time output voltage. It will persist in this behavior until V_{IN} is no longer present.

If trim is active when the DCM is operating, the TR pin provides dynamic trim control at a typical 250 Hz of -3dB bandwidth over the output voltage. TR also decreases the current limit threshold when trimming above $V_{OUT-NOM}$.

+SENSE, -SENSE

These pins are Remote Sense pins, which allow the users to sense the voltage at the point of load so that the DCM can use the load voltage to regulate its output voltage accordingly. If “+SENSE” and “-SENSE” are floating, Local Sense is implemented automatically.

However, when SENSE pins are floating, the regulation accuracy deteriorates (see “ V_{OUT} accuracy with Sense pin floating” on Page 5). To achieve maximum regulation accuracy, the SENSE pins should be used also for local sense operation, by connecting them directly to their respective OUT pins (+SENSE to +OUT and -SENSE to -OUT).

Please note: For chassis mount models, Vicor part number 42550 will be needed for applications requiring the use of signal pins (Enable, Trim and Sense functions).

Design Guidelines

Building Blocks and System Design

The DCM converter input accepts the full 16.0 to 50.0 V range, and it generates an isolated trimmable 12.0 Vdc output.

The DCM converter provides a tightly regulated output voltage. With trim inactive (TR pin floating), regulation accuracy is within 0.5% of the setpoint for all line conditions and for any load above 10% of the rated load. With trim active, regulation accuracy is within 2.0% for all line conditions and for any load condition above 10% of the rated load.

The DCM3414x50M13C2yzz is designed to be used in applications where the output power requirements are up to 320 W.

Soft Start

When the DCM starts, it will go through a soft start. The soft start routine ramps the output voltage by modulating the internal error amplifier reference. This causes the output voltage to approximate a piecewise linear ramp. The output ramp finishes when the voltage reaches either the nominal output voltage, or the trimmed output voltage in cases where trim mode is active.

During soft-start, the maximum load current capability is reduced. Until V_{out} achieves at least $V_{OUT-FL-THRESH}$, the output current must be less than $I_{OUT-START}$ in order to guarantee startup. Note that this is current available to the load, above that which is required to charge the output capacitor.

Trim Mode and Output Trim Control

When the input voltage is initially applied to a DCM, and after t_{INIT} elapses, the trim pin voltage V_{TR} is sampled. The TR pin has an internal pull up resistor to V_{CC} , so unless external circuitry pulls the pin voltage lower, it will pull up to V_{CC} . If the initially sampled trim pin voltage is higher than $V_{TRIM-DIS}$, then the DCM will disable trimming as long as the V_{IN} remains applied. In this case, for all subsequent operation the output voltage will be programmed to the nominal. This minimizes the support components required for applications that only require the nominal rated V_{OUT} , and also provides the best output setpoint accuracy, as there are no additional errors from external trim components.

If at initial application of V_{IN} , the TR pin voltage is prevented from exceeding $V_{TRIM-EN}$, then the DCM will activate trim mode, and it will remain active for as long as V_{IN} is applied.

V_{OUT} set point can be calculated using the equation below:

$$V_{OUT-TRIMMING} = 6.600 + (7.512 \cdot V_{TR}/V_{CC}) \quad (1)$$

Note that the trim mode is not changed when a DCM recovers from any fault condition or being disabled.

Module performance is guaranteed through output voltage trim range $V_{OUT-TRIMMING}$. If V_{OUT} is trimmed above this range, then certain combinations of line and load transient conditions may trigger the output OVP.

Output Current Limit

The DCM features a fully operational current limit which effectively keeps the module operating inside the Safe Operating Area (SOA) for all valid trim and load profiles. The current limit approximates a “brick wall” limit, where the output current is

prevented from exceeding the current limit threshold by reducing the output voltage via the internal error amplifier reference. The current limit threshold at nominal trim and below is typically 115% of rated output current, but it can vary between 103% to 135%. In order to preserve the SOA, when the converter is trimmed above the nominal output voltage, the current limit threshold is automatically reduced to limit the available output power.

When the output current exceeds the current limit threshold, current limit action is held off by 1ms, which permits the DCM to momentarily deliver higher peak output currents to the load. Peak output power during this time is still constrained by the internal Power Limit of the module. The fast Power Limit and relatively slow Current Limit work together to keep the module inside the SOA. Delaying entry into current limit also permits the DCM to minimize droop voltage for load steps.

Sustained operation in current limit is permitted, and no derating of output power is required.

Current limit can reduce the output voltage to as little as the UVP threshold ($V_{OUT-UVLP}$). Below this minimum output voltage compliance level, further loading will cause the module to shut down due to the output undervoltage fault protection.

Line Impedance, Input Slew rate and Input Stability Requirements

Connect a high-quality, low-noise power supply to the +IN and -IN terminals. Additional capacitance may have to be added between +IN and -IN to make up for impedances in the interconnect cables as well as deficiencies in the source.

Excessive source impedance can bring about system stability issues for a regulated DC-DC converter, and must either be avoided or compensated. A 1000 μ F input capacitor is the minimum recommended in case the source impedance is insufficient to satisfy stability requirements.

Additional information can be found in the filter design application note:

www.vicorpower.com/documents/application_notes/vichip_appnote23.pdf

Please refer to this input filter design tool to ensure input stability: <http://app2.vicorpower.com/filterDesign/intiFilter.do>.

Ensure that the input voltage slew rate is less than 1V/us, otherwise a pre-charge circuit is required for the DCM input to control the input voltage slew rate and prevent overstress to input stage components.

Input Fuse Selection

The DCM is not internally fused in order to provide flexibility in configuring power systems. Input line fusing is recommended at the system level, in order to provide thermal protection in case of catastrophic failure. The fuse shall be selected by closely matching system requirements with the following characteristics:

- Current rating (usually greater than the DCM converter's maximum current)
- Maximum voltage rating (usually greater than the maximum possible input voltage)
- Ambient temperature
- Breaking capacity per application requirements
- Nominal melting I^2t
- Recommended fuse: See Agency Approvals for Recommended Fuse <http://www.vicorpower.com>

Fault Handling

Input Undervoltage Fault Protection (UVLO)

The converter's input voltage is monitored to detect an input under voltage condition. If the converter is not already running, then it will ignore enable commands until the input voltage is greater than $V_{IN-UVLO+}$. If the converter is running and the input voltage falls below $V_{IN-UVLO-}$, the converter recognizes a fault condition, the powertrain stops switching, and the output voltage of the unit falls.

Input voltage transients which fall below UVLO for less than t_{UVLO} may not be detected by the fault protection logic, in which case the converter will continue regular operation. No protection is required in this case.

Once the UVLO fault is detected by the fault protection logic, the converter shuts down and waits for the input voltage to rise above $V_{IN-UVLO+}$. Provided the converter is still enabled, it will then restart.

Input Overvoltage Fault Protection (OVLO)

The converter's input voltage is monitored to detect an input over voltage condition. When the input voltage is more than the $V_{IN-OVLO+}$, a fault is detected, the powertrain stops switching, and the output voltage of the converter falls.

After an OVLO fault occurs, the converter will wait for the input voltage to fall below $V_{IN-OVLO-}$. Provided the converter is still enabled, the powertrain will restart.

The powertrain controller itself also monitors the input voltage. Transient OVLO events which have not yet been detected by the fault sequence logic may first be detected by the controller if the input slew rate is sufficiently large. In this case, powertrain switching will immediately stop. If the input voltage falls back in range before the fault sequence logic detects the out of range condition, the powertrain will resume switching and the fault logic will not interrupt operation. Regardless of whether the powertrain is running at the time or not, if the input voltage does not recover from OVLO before t_{OVLO} , the converter fault logic will detect the fault.

Output Undervoltage Fault Protection (UVP)

The converter determines that an output overload or short circuit condition exists by measuring its output voltage and the output of the internal error amplifier. In general, whenever the powertrain is switching and the output voltage falls below $V_{OUT-UVP}$ threshold, a short circuit fault will be registered. Once an output undervoltage condition is detected, the powertrain immediately stops switching, and the output voltage of the converter falls. The converter remains disabled for a time t_{FAULT} . Once recovered and provided the converter is still enabled, the powertrain will again enter the soft start sequence after t_{INIT} and t_{ON} .

Temperature Fault Protections (OTP)

The fault logic monitors the internal temperature of the converter. If the measured temperature exceeds $T_{INT-OTP}$, a temperature fault is registered. As with the under voltage fault protection, once a temperature fault is registered, the powertrain immediately stops switching, the output voltage of the converter falls, and the converter remains disabled for at least time t_{FAULT} . Then, the converter waits for the internal temperature to return to below $T_{INT-OTP}$ before recovering. Provided the converter is still enabled, the DCM will restart after t_{INIT} and t_{ON} .

Output Overvoltage Fault Protection (OVP)

The converter monitors the output voltage during each switching cycle. If the output voltage exceeds V_{OUT_OVP} , the OVP fault protection is triggered. The control logic disables the powertrain, and the output voltage of the converter falls.

This type of fault is latched, and the converter will not start again until the latch is cleared. Clearing the fault latch is achieved by either disabling the converter via the EN pin, or else by removing the input power such that the input voltage falls below V_{IN_INIT} .

External Output Capacitance

The DCM converter internal compensation requires a minimum external output capacitor. An external capacitor in the range of 1000 to 10000 μ F with ESR of 10 m Ω is required for control loop compensation purposes.

However some DCM models require an increase to the minimum external output capacitor value in certain loading condition. In applications where the load can go below 2% of rated load, the range of output capacitor required is given by

$C_{OUT_EXT_TRANSIENT}$ in the Electrical Specifications table.

Thermal Considerations

The VIA package provides effective conduction cooling from either of the two module surfaces. Heat may be removed from the top surface, the bottom surface or both. The extent to which these two surfaces are cooled is a key component for determining the maximum power that can be processed by a DCM in a VIA package, as can be seen from specified thermal operating area on Page 4. Since the VIA package has a maximum internal temperature rating, it is necessary to estimate this internal temperature based on a system-level thermal solution. To this purpose, it is helpful to simplify the thermal solution into a roughly equivalent circuit where power dissipation is modeled as a current source, isothermal surface temperatures are represented as voltage sources and the thermal resistances are represented as resistors. Figure 18 shows the “thermal circuit” for the VIA package.

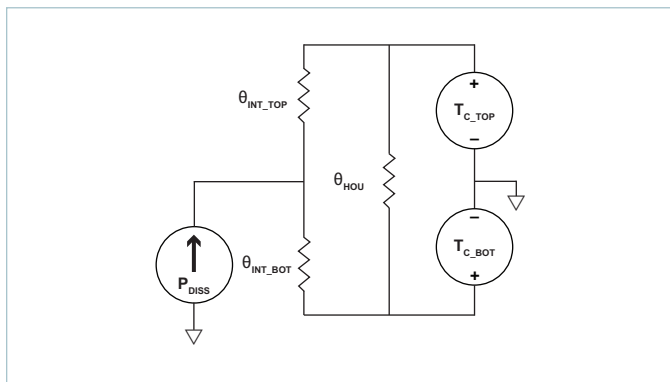

Figure 18 – Double sided cooling VIA thermal model

In this case, the internal power dissipation is P_{DISS} , θ_{INT_TOP} and θ_{INT_BOT} are thermal resistance characteristics of the VIA package and the top and bottom surface temperatures are represented as T_{C_TOP} and T_{C_BOT} . It is interesting to notice that the package itself provides a high degree of thermal coupling between the top and bottom case surfaces (represented in the model by the resistor θ_{HOU}). This feature enables two main options regarding thermal designs:

- Single side cooling: the model of Figure 18 can be simplified by calculating the parallel resistor network and using one simple thermal resistance number and the internal power dissipation curves; an example for bottom side cooling only is shown in Figure 19.

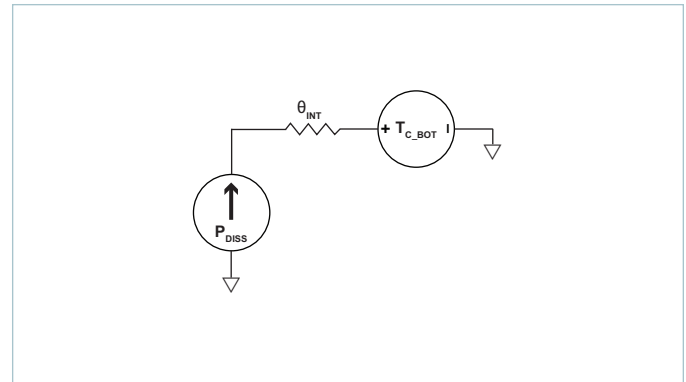

Figure 19 – Single-sided cooling VIA thermal model

In this case, R_{JC} can be derived as following:

$$\theta_{INT} = \frac{(\theta_{INT_TOP} + \theta_{HOU}) \cdot \theta_{INT_BOT}}{\theta_{INT_TOP} + \theta_{HOU} + \theta_{INT_BOT}}$$

- Double side cooling: while this option might bring limited advantage to the module internal components (given the surface-to-surface coupling provided), it might be appealing in cases where the external thermal system requires allocating power to two different elements, like for example heatsinks with independent airflows or a combination of chassis/air cooling.

Grounding Considerations

The chassis of the VIA package is required to be connected to Protective Earth when installed in the end application and must satisfy the requirements of IEC 60950-1 for Class I products. Both sides of the housing are required to be connected to Protective Earth to satisfy safety and EMI requirements. Protective earthing can be accomplished through dedicated wiring harness (example: ring terminal clamped by mounting screw) or surface contact (example: pressure contact on bare conductive chassis or PCB copper layer with no solder mask).

DCM in a VIA package Module Mechanical Drawing - PCB Mount Type

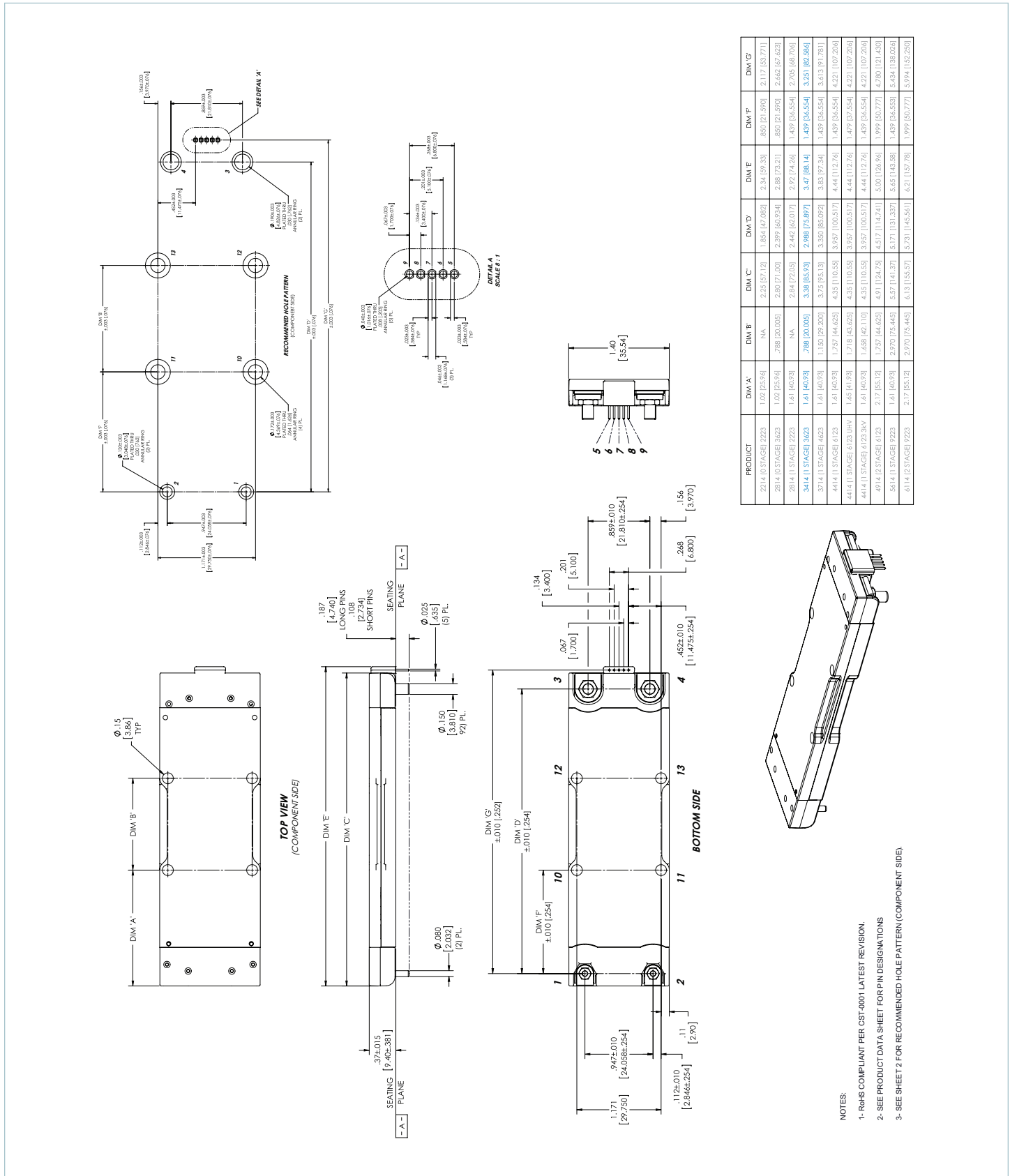

DCM in a VIA package Module Mechanical Drawing - Chassis Mount Type

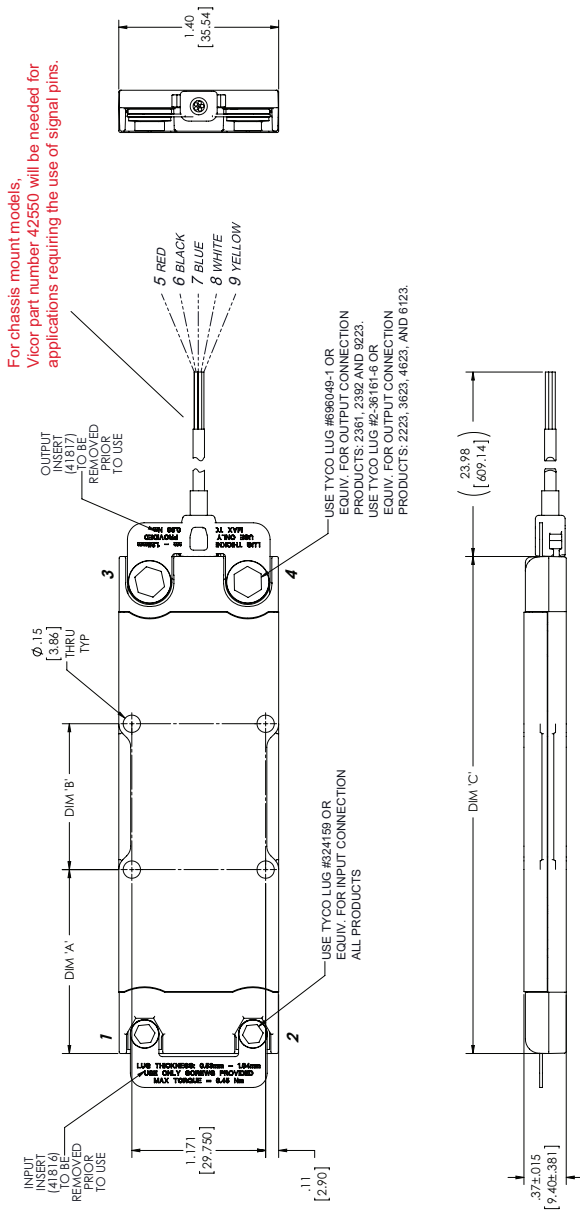

PRODUCT	DIM 'A'	DIM 'B'	DIM 'C'
2214 (0 STAGE) 2223	1.02 [25.94]	NA	2.25 [57.12]
2814 (0 STAGE) 3623	1.02 [25.94]	.788 [20.006]	2.80 [71.00]
2814 (1 STAGE) 2223	1.61 [40.93]	NA	2.84 [72.05]
3414 (1 STAGE) 3623	1.61 [40.93]	.788 [20.006]	3.38 [85.93]
3714 (1 STAGE) 4623	1.61 [40.93]	1.150 [29.200]	3.75 [95.13]
3814 (0 STAGE) 2361	1.02 [25.94]	1.277 [32.430]	3.76 [95.59]
4414 (1 STAGE) 2361	1.61 [40.93]	1.277 [32.430]	4.35 [110.55]
4414 (1 STAGE) 6123	1.61 [40.93]	1.757 [44.625]	4.35 [110.55]
4414 (1 STAGE) 6123 UHV	1.61 [40.93]	1.718 [43.625]	4.35 [110.55]
4414 (1 STAGE) 6123 3KV	1.61 [40.93]	1.658 [42.100]	4.35 [110.55]
4914 (2 STAGE) 2361	2.17 [55.12]	1.277 [32.430]	4.91 [124.73]
4914 (2 STAGE) 6123	2.17 [55.12]	1.757 [44.625]	4.91 [124.73]
5614 (1 STAGE) 9223	1.61 [40.93]	2.970 [75.445]	5.57 [141.37]
6114 (2 STAGE) 9223	2.17 [55.12]	2.970 [75.445]	6.13 [155.57]

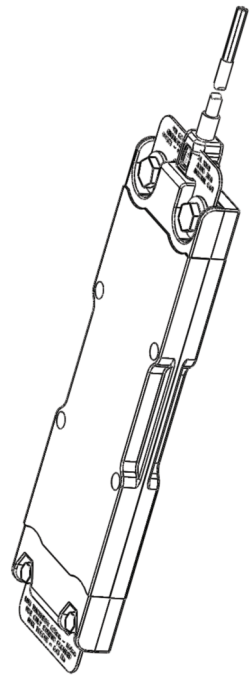

NOTES:
 1- R0HS COMPLIANT PER CST-0001 LATEST REVISION
 2- SEE PRODUCT DATA SHEET FOR PIN DESIGNATIONS

Revision History

Revision	Date	Description	Page Number(s)
1.0	09/08/15	Intital release	n/a
1.1	09/30/15	Added graphic reference on Pin Configuration	3
1.2	10/01/15	Updated trim resolution value	7
1.3	10/13/15	Updated peak efficiency & case temperature	1
1.4	12/17/15	Added VDDE current consumption spec	7
1.5	02/16/16	Updated pin configuration and pin descriptions	3
1.6	03/31/16	Updated thermal capacitance value	14
1.7	05/05/16	Updated figure 1 Updated timing diagram notes page Updated thermal capacity spec	4 9 & 10 14
1.8	05/31/16	Updated figure 1	4
1.9	05/18/17	Updated input overvoltage lockout/recovery threshold (powertrain protections) values to match the OVLO operating points of the product Updated height specifications, added pin description	6 14
2.0	07/13/17	Updated typical application bullets Updated product photos Moved remote sense rated voltage drop value to maximum column Updated mechanical drawings (including new hex-head screws)	1 1 8 20 & 21

Vicor's comprehensive line of power solutions includes high density AC-DC and DC-DC modules and accessory components, fully configurable AC-DC and DC-DC power supplies, and complete custom power systems.

Information furnished by Vicor is believed to be accurate and reliable. However, no responsibility is assumed by Vicor for its use. Vicor makes no representations or warranties with respect to the accuracy or completeness of the contents of this publication. Vicor reserves the right to make changes to any products, specifications, and product descriptions at any time without notice. Information published by Vicor has been checked and is believed to be accurate at the time it was printed; however, Vicor assumes no responsibility for inaccuracies. Testing and other quality controls are used to the extent Vicor deems necessary to support Vicor's product warranty. Except where mandated by government requirements, testing of all parameters of each product is not necessarily performed.

Specifications are subject to change without notice.

Vicor's Standard Terms and Conditions

All sales are subject to Vicor's Standard Terms and Conditions of Sale, which are available on Vicor's webpage or upon request.

Product Warranty

In Vicor's standard terms and conditions of sale, Vicor warrants that its products are free from non-conformity to its Standard Specifications (the "Express Limited Warranty"). This warranty is extended only to the original Buyer for the period expiring two (2) years after the date of shipment and is not transferable.

UNLESS OTHERWISE EXPRESSLY STATED IN A WRITTEN SALES AGREEMENT SIGNED BY A DULY AUTHORIZED VICOR SIGNATORY, VICOR DISCLAIMS ALL REPRESENTATIONS, LIABILITIES, AND WARRANTIES OF ANY KIND (WHETHER ARISING BY IMPLICATION OR BY OPERATION OF LAW) WITH RESPECT TO THE PRODUCTS, INCLUDING, WITHOUT LIMITATION, ANY WARRANTIES OR REPRESENTATIONS AS TO MERCHANTABILITY, FITNESS FOR PARTICULAR PURPOSE, INFRINGEMENT OF ANY PATENT, COPYRIGHT, OR OTHER INTELLECTUAL PROPERTY RIGHT, OR ANY OTHER MATTER.

This warranty does not extend to products subjected to misuse, accident, or improper application, maintenance, or storage. Vicor shall not be liable for collateral or consequential damage. Vicor disclaims any and all liability arising out of the application or use of any product or circuit and assumes no liability for applications assistance or buyer product design. Buyers are responsible for their products and applications using Vicor products and components. Prior to using or distributing any products that include Vicor components, buyers should provide adequate design, testing and operating safeguards.

Vicor will repair or replace defective products in accordance with its own best judgment. For service under this warranty, the buyer must contact Vicor to obtain a Return Material Authorization (RMA) number and shipping instructions. Products returned without prior authorization will be returned to the buyer. The buyer will pay all charges incurred in returning the product to the factory. Vicor will pay all reshipment charges if the product was defective within the terms of this warranty.

Life Support Policy

VICOR'S PRODUCTS ARE NOT AUTHORIZED FOR USE AS CRITICAL COMPONENTS IN LIFE SUPPORT DEVICES OR SYSTEMS WITHOUT THE EXPRESS PRIOR WRITTEN APPROVAL OF THE CHIEF EXECUTIVE OFFICER AND GENERAL COUNSEL OF VICOR CORPORATION. As used herein, life support devices or systems are devices which (a) are intended for surgical implant into the body, or (b) support or sustain life and whose failure to perform when properly used in accordance with instructions for use provided in the labeling can be reasonably expected to result in a significant injury to the user. A critical component is any component in a life support device or system whose failure to perform can be reasonably expected to cause the failure of the life support device or system or to affect its safety or effectiveness. Per Vicor Terms and Conditions of Sale, the user of Vicor products and components in life support applications assumes all risks of such use and indemnifies Vicor against all liability and damages.

Intellectual Property Notice

Vicor and its subsidiaries own Intellectual Property (including issued U.S. and Foreign Patents and pending patent applications) relating to the products described in this data sheet. No license, whether express, implied, or arising by estoppel or otherwise, to any intellectual property rights is granted by this document. Interested parties should contact Vicor's Intellectual Property Department.

The products described on this data sheet are protected by the following U.S. Patents Numbers: RE40,072; 7,561,446; 7,920,391; 7,782,639; 8,966,747; 8,427,269; 6,421,262 and other patents pending.

Vicor Corporation
25 Frontage Road
Andover, MA, USA 01810
Tel: 800-735-6200
Fax: 978-475-6715

email

Customer Service: custserv@vicorpower.com
Technical Support: apps@vicorpower.com