

Data sheet | Item number: 789-1544

Relay module; Nominal input voltage: 230 VAC; 1 changeover contact;
Limiting continuous current: 12 A; with manual operation; Red status
indicator; Module width: 18 mm; 2,50 mm²

www.wago.com/789-1544



Similar to picture

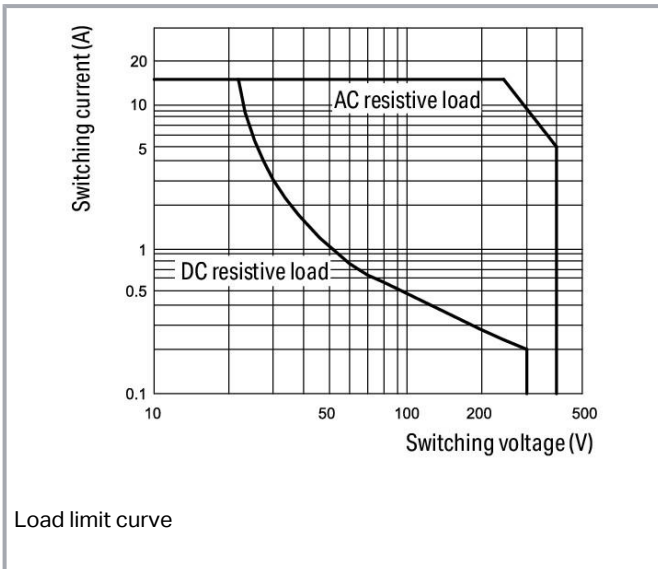
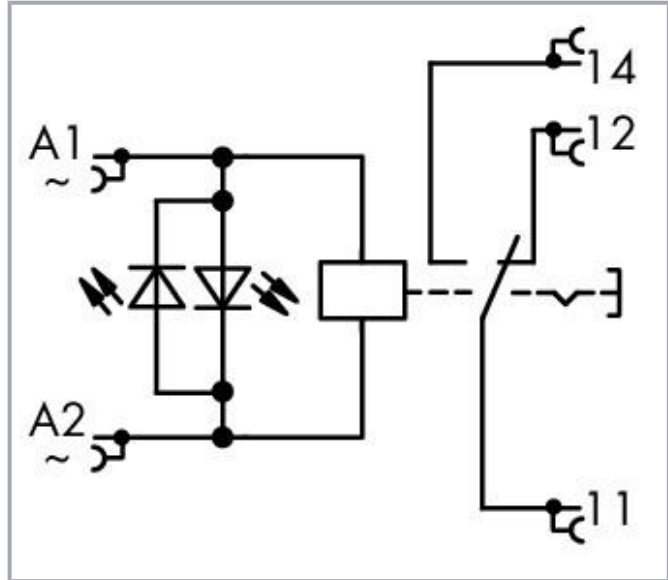

Load limit curve

Data Notes

Note

Subject to changes. Please also observe the further product documentation!

WAGO Kontakttechnik GmbH & Co. KG
Hansastr. 27
32423 Minden
Phone: +49571 887-0 | Fax: +49571 887-169
Email: info.de@wago.com | Web: www.wago.com

Do you have any questions about our products?
We are always happy to take your call at +49 (571) 887-44222.



To protect the relay coils and contacts, inductive loads must be dampened with an effective protection circuit.

Technical data

Control circuit

Nominal input voltage U_N	AC 230 V
Input voltage range	$\pm 10\%$
Nominal input current at U_N	3.5 mA

Load circuit

Number of changeover/switchover contacts	1
Contact material (relay)	AgNi
Limiting continuous current	12 A
Inrush current (resistive) (max.)	(AC) 30 A / 0.02 s; (AC) 24 A / 4 s
Switching voltage (max.)	AC 250 V
Switching power (resistive) (max.)	AC 3000 VA; DC (see load limit curve)
Recommended minimum load	12 V / 10 mA
Pull-in time (typ.)	15 ms
Drop-out time (typ.)	8 ms
Bounce time (typ.)	6 ms
Mechanical life	5×10^6 switching operations

Signaling

Status indicator	Red LED
------------------	---------

Safety and protection

Rated voltage	250 V
Rated surge voltage	4 kV
Pollution degree	2
Dielectric strength, control/load circuit (AC, 1 min)	3.5 kVrms
Dielectric strength, open contact (AC, 1 min)	1 kVrms
Protection type	IP20

Subject to changes. Please also observe the further product documentation!



Connection data

Connection technology	CAGE CLAMP®
Solid conductor	0.2 ... 2.5 mm ² / 24 ... 14 AWG
Fine-stranded conductor	0.2 ... 2.5 mm ² / 24 ... 14 AWG
Strip length	9 ... 10 mm / 0.35 ... 0.39 inch

Physical data

Width	17.5 mm / 0.689 inch
Height	90 mm / 3.543 inch
Depth from upper edge of DIN-rail	55 mm / 2.165 inch

Mechanical data

Mounting type	DIN-35 rail
---------------	-------------

Material data

Fire load	0.732 MJ
Weight	50.2 g

Environmental requirements

Surrounding air temperature (operation at U _N)	-25 ... 50 °C
Surrounding air temperature (storage)	-40 ... 70 °C
Processing temperature	-25 ... +50 °C

Standards and specifications

Standards/Specifications	EN 60664-1
--------------------------	------------

Commercial data













Product Group	6 (Interface Electronics)
PU (SPU)	10 (1) Stück
Packaging type	box
Country of origin	DE
GTIN	4050821386780
Customs tariff number	85364900990

Subject to changes. Please also observe the further product documentation!









WAGO Kontakttechnik GmbH & Co. KG
 Hansastr. 27
 32423 Minden
 Phone: +49571 887-0 | Fax: +49571 887-169
 Email: info.de@wago.com | Web: www.wago.com

Do you have any questions about our products?
 We are always happy to take your call at +49 (571) 887-44222.

Optional accessories

Ferrule		
	Item no.: 216-241 Ferrule; Sleeve for 0.5 mm ² / 20 AWG; insulated; electro-tin plated; electrolytic copper; gastight crimped; acc. to DIN 46228, Part 4/09.90; white	www.wago.com/216-241
	Item no.: 216-242 Ferrule; Sleeve for 0.75 mm ² / 18 AWG; insulated; electro-tin plated; electrolytic copper; gastight crimped; acc. to DIN 46228, Part 4/09.90; gray	www.wago.com/216-242
	Item no.: 216-243 Ferrule; Sleeve for 1 mm ² / AWG 18; insulated; electro-tin plated; electrolytic copper; gastight crimped; acc. to DIN 46228, Part 4/09.90; red	www.wago.com/216-243
	Item no.: 216-244 Ferrule; Sleeve for 1.5 mm ² / AWG 16; insulated; electro-tin plated; electrolytic copper; gastight crimped; acc. to DIN 46228, Part 4/09.90; black	www.wago.com/216-244
Tool		
Operating tool		
	Item no.: 210-720 Operating tool; Blade: 3.5 x 0.5 mm; with a partially insulated shaft; multicoloured	www.wago.com/210-720
Jumpers		
Jumper		
	Item no.: 789-112 Jumper; 12-way; silver-colored	www.wago.com/789-112
Marking accessories		
Marking device		
	Item no.: 210-110 Fiber-tip pen	www.wago.com/210-110
Marker		
	Item no.: 2009-145 Mini-WSB Inline; for Smart Printer; 1700 pieces on roll; stretchable 5 - 5.2 mm; plain; snap-on type; white	www.wago.com/2009-145
	Item no.: 248-451 Mini-WSB marking card; as card; MARKED; K11 - K20 (10x); not stretchable; Horizontal marking; snap-on type; white	www.wago.com/248-451
	Item no.: 248-455 Mini-WSB marking card; as card; MARKED; U 100 (10x); not stretchable; Horizontal marking; snap-on type; white	www.wago.com/248-455
	Item no.: 248-450 Mini-WSB marking card; as card; MARKED; K1 - K10 (10x); not stretchable; Horizontal marking; snap-on type; white	www.wago.com/248-450
	Item no.: 248-452 Mini-WSB marking card; as card; MARKED; K (100x); not stretchable; Horizontal marking; snap-on type; white	www.wago.com/248-452

Subject to changes. Please also observe the further product documentation!

	Item no.: 248-453 Mini-WSB marking card; as card; MARKED; U1, ... U10 (10x); not stretchable; Horizontal marking; snap-on type; white	www.wago.com/248-453
	Item no.: 248-454 Mini-WSB marking card; as card; MARKED; U11 - U20 (10x); not stretchable; Horizontal marking; snap-on type; white	www.wago.com/248-454
	Item no.: 248-566 Mini-WSB marking card; as card; MARKED; 1 ... 50 (2x); not stretchable; Horizontal marking; snap-on type; white	www.wago.com/248-566
	Item no.: 248-501 Mini-WSB marking card; as card; not stretchable; plain; snap-on type; white	www.wago.com/248-501
	Item no.: 248-504 Mini-WSB marking card; as card; MARKED; 21 ... 30 (10x); not stretchable; Horizontal marking; snap-on type; white	www.wago.com/248-504
	Item no.: 248-503 Mini-WSB marking card; as card; MARKED; 11 ... 20 (10x); not stretchable; Horizontal marking; snap-on type; white	www.wago.com/248-503
	Item no.: 248-506 Mini-WSB marking card; as card; MARKED; 41 ... 50 (10x); not stretchable; Horizontal marking; snap-on type; white	www.wago.com/248-506
	Item no.: 248-502 Mini-WSB marking card; as card; MARKED; 1 ... 10 (10x); not stretchable; Horizontal marking; snap-on type; white	www.wago.com/248-502

Downloads

Documentation

Bid Text

789-1544 X81 - Datei	2019. 2. 19.	xml 4.6 kB	Download
-------------------------	--------------	---------------	----------

789-1544 docx - Datei	2019. 2. 20.	docx 17.2 kB	Download
--------------------------	--------------	-----------------	----------

Instruction Leaflet

		pdf 1.3 MB	Download
--	--	---------------	----------

Additional Information

Disposal; Electrical and electronic equipment, Packaging	V 1.0.0	pdf 265.8 kB	Download
--	---------	-----------------	----------

Subject to changes. Please also observe the further product documentation!

WAGO Kontakttechnik GmbH & Co. KG
Hansastr. 27
32423 Minden
Phone: +49571 887-0 | Fax: +49571 887-169
Email: info.de@wago.com | Web: www.wago.com

Do you have any questions about our products?
We are always happy to take your call at +49 (571) 887-44222.

CAD/CAE-Data

CAE data

EPLAN Data Portal 789-1544	URL	Download
WSCAD Universe 789-1544	URL	Download
ZUKEN Portal 789-1544	URL	Download

CAD data

2D/3D Models 789-1544	URL	Download
-----------------------	---------------------	--------------------------

Environmental Product Compliance

Compliance Search

Environmental Product Compliance 789-1544	URL	Download
Relay module; Nominal input voltage: 230 VAC; 1 changeover contact; Limiting continuous current: 12 A; with manual operation; Red status indicator; Module width: 18 mm; 2,50 mm ²		

Installation Notes

Conductor termination

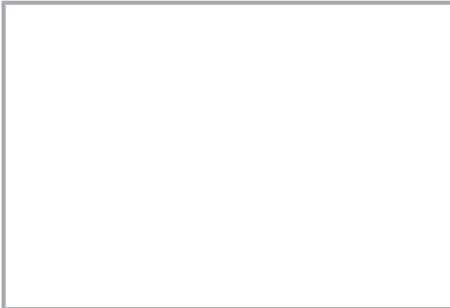

Inserting a conductor.

Commoning

Subject to changes. Please also observe the further product documentation!

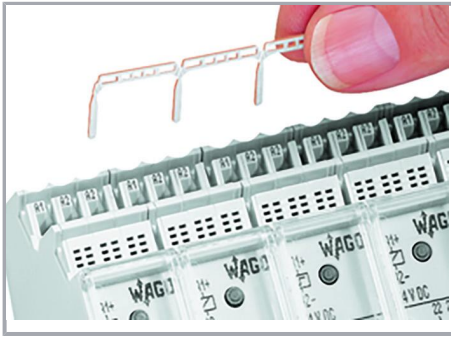

Easy commoning via adjacent jumpers.

Marking

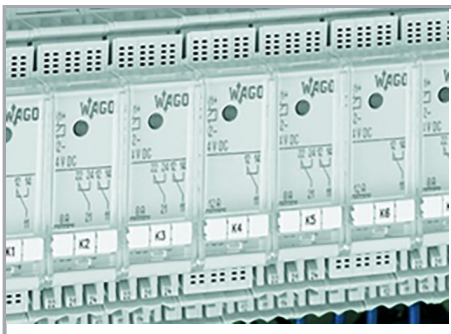

Marking via Mini-WSB Quick Marking System.

Subject to changes. Please also observe the further product documentation!