

HFBR-5208M and HFCT-5208M

1 x 9 Fiber Optic Transceivers for 622 Mb/s
ATM/SONET/SDH Applications

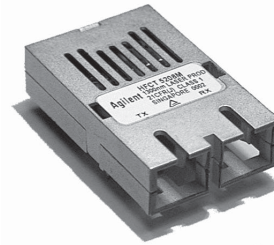

Data Sheet

Description

General

The HFBR-5208M (multimode transceiver) and HFCT-5208M (single-mode transceiver) from Avago Technologies allow the system designer to implement a range of solutions for ATM/SONET STS-12/SDH STM-4 applications.

The overall Avago Technologies transceiver consists of three sections: the transmitter and receiver optical subassemblies, an electrical subassembly and the mezzanine package housing which incorporates a duplex SC connector receptacle.

Applications

HFBR-5208M:

- General purpose low-cost MMF links at 155 to 650 Mb/s
- ATM 622 Mb/s MMF links from switch-to-switch or switch-to-server in the end-user premise
- Private MMF interconnections at 622 Mb/s SONET STS-12/SDH STM-4 rate

HFCT-5208M:

- ATM 622 Mb/s SMF links from switch-to-switch or switch-to-server in the end-user premise
- Private SMF interconnections at 622 Mb/s SONET STS-12/SDH STM-4 rate

622 Mb/s Product Family

HFCT-5218M:

- 1300 nm laser-based transceiver in 1 x 9 package for links of 40 km with single-mode fiber cables

Features

- Performance
HFBR-5208M:
Links of 500 m with 62.5/125 μ m multimode fiber (MMF) from 155-622 Mb/s
HFCT-5208M:
Links of 15 km with 9/125 μ m single-mode fiber (SMF)
- Compliant with ATM forum
622.08 Mb/s physical layer specification (AF-PHY-0046.000)
- Compliant with ANSI broadband ISDN - physical layer specification T1.646-1995 and T1.646a-1997
- HFBR-5208M is compliant with ANSI network to customer installation interfaces - synchronous optical NETWORK (SONET) physical media dependent specification: multimode fiber T1.416.01-1998
- HFCT-5208M is compliant to the intermediate SONET OC12/SDH STM(S4.1) specifications
- Industry-standard multi-sourced 1 x 9 mezzanine package style
- Single +5 V power supply operation and PECL logic interfaces
- Wave solder and aqueous wash process compatible
- Unconditionally eye safe laser IEC 825/CDRH Class 1 compliant

Transmitter Section

The transmitter section of the HFBR-5208M consists of a 1300 nm LED in an optical subassembly (OSA) which mates to the multimode fiber cable. The HFCT-5208M incorporates a 1300 nm Fabry Perot (FP) laser in the optical subassembly. In addition, this package has been designed to be compliant with IEC 825 eye-safety requirements under any single fault condition. The OSA's are driven by a custom, silicon bipolar IC which converts differential PECL logic signals (ECL referenced to a +5 V supply) into an analog LED/laser drive current.

Receiver Section

The receiver contains an InGaAs PIN photodiode mounted together with a custom, silicon bipolar transimpedance preamplifier IC in an OSA. This OSA is mated to a custom, silicon bipolar circuit providing post amplification and quantization and optical signal detection.

The custom, silicon bipolar circuit includes a Signal Detect circuit which provides a PECL logic high state output upon detection of a usable input optical signal level. This single-ended PECL output is designed to drive a standard PECL input through normal 50 Ω PECL load.

Applications Information

Typical BER Performance of HFBR-5208M Receiver versus Input Optical Power Level

The HFBR/HFCT-5208M transceiver can be operated at Bit-Error-Ratio conditions other than the required BER = 1×10^{-10} of the 622 MBd ATM Forum 622.08 Mb/s Physical Layer Standard and the ANSI T1.646a. The typical trade-off of BER versus Relative Input Optical Power is shown in Figure 1. The Relative Input Optical Power in dB is referenced to the Input Optical Power parameter value in the Receiver Optical Characteristics table. For better BER condition than 1×10^{-10} , more input signal is needed (+dB).

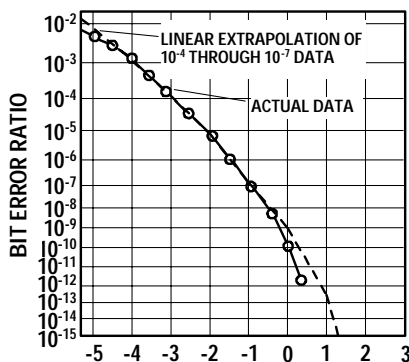

Figure 1. Relative Input Optical Power -dBm Average.

For example, to operate the HFBR-5208M at a BER of 1×10^{-12} , the receiver will require an input signal approximately 0.6 dB higher than the -26 dBm level required for 1×10^{-10} operation, i.e. -25.4 dBm.

An informative graph of a typical, short fiber transceiver link performance can be seen in Figure 2. This figure is useful for designing short reach links with time-based jitter requirements. This figure indicates Relative Input Optical Power versus Sampling Time Position within the receiver output data eye-opening. The given curves are at a constant bit-error-ratio (BER) of 10^{-10} for four different signaling rates, 155 MBd, 311 MBd, 622 MBd and 650 MBd. These curves, called "tub" diagrams for their shape, show the amount of data eye-opening time-width for various receiver input optical power levels. A wider data eye-opening provides more time for the clock recovery circuit to operate within without creating errors. The deeper the tub is indicates less input optical power is needed to operate the receiver at the same BER condition. Generally, the wider and deeper the tub is the better. The Relative Input Optical Power amount (dB) is referenced to the absolute level (dBm avg.) given in the Receiver Optical Characteristics table. The 0 ns sampling time position for this Figure 2 refers to the center of the Baud interval for the particular signaling rate. The Baud interval is the reciprocal of the signaling rate in MBd. For example, at 622 MBd the Baud interval is 1.61 ns, at 155 MBd the Baud interval is 6.45 ns. Test conditions for this tub diagram are listed in Figure 2.

The HFBR/HFCT-5208M receiver input optical power requirements vary slightly over the signaling rate range of 20 MBd to 700 MBd for a constant bit-error-ratio (BER) of 10^{-10} condition. Figure 3 illustrates the typical receiver relative input optical power varies by ≤ 0.7 dB over this full range. This small sensitivity variation allows the optical budget to remain nearly constant for designs that make use of the broad signaling rate range of the HFBR/HFCT-5208M. The curve has been normalized to the input optical power level (dBm avg.) of the receiver for 622 MBd at center of the Baud interval with a BER of 10^{-10} . The data patterns that can be used at these signaling rates should be, on average, balanced duty factor of 50%. Momentary excursions of less or more data duty factor than 50% can occur, but the overall data pattern must remain balanced. Unbalanced data duty factor will cause excessive pulse-width distortion, or worse, bit errors. The test conditions are listed in Figure 3.

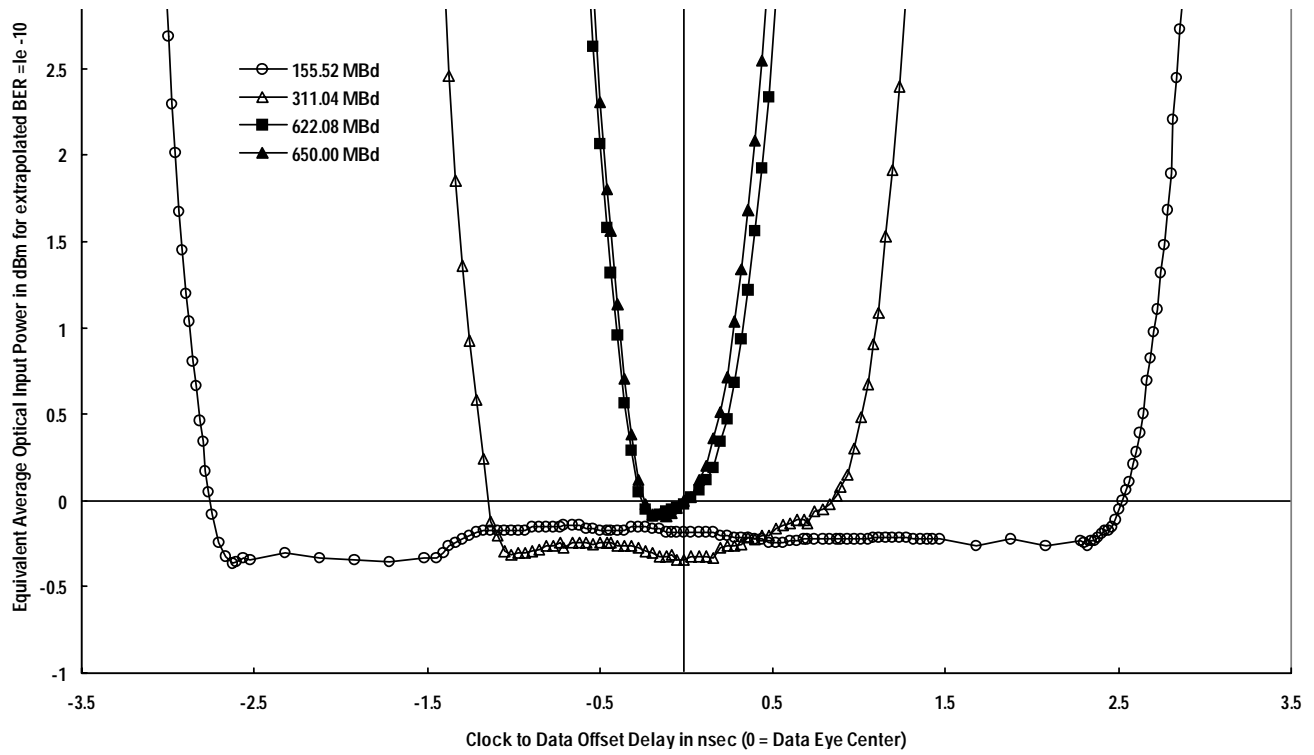

Figure 2. HFBR-5208M Relative Input Optical Power as a function of sampling time position. Normalized to center of Baud interval at 622MBd. Test Conditions +25°C, 5.25V, PRBS2²³-1, optical $\tau_r/\tau_f=0.9$ ns with 3m of 62.5µm MMF.

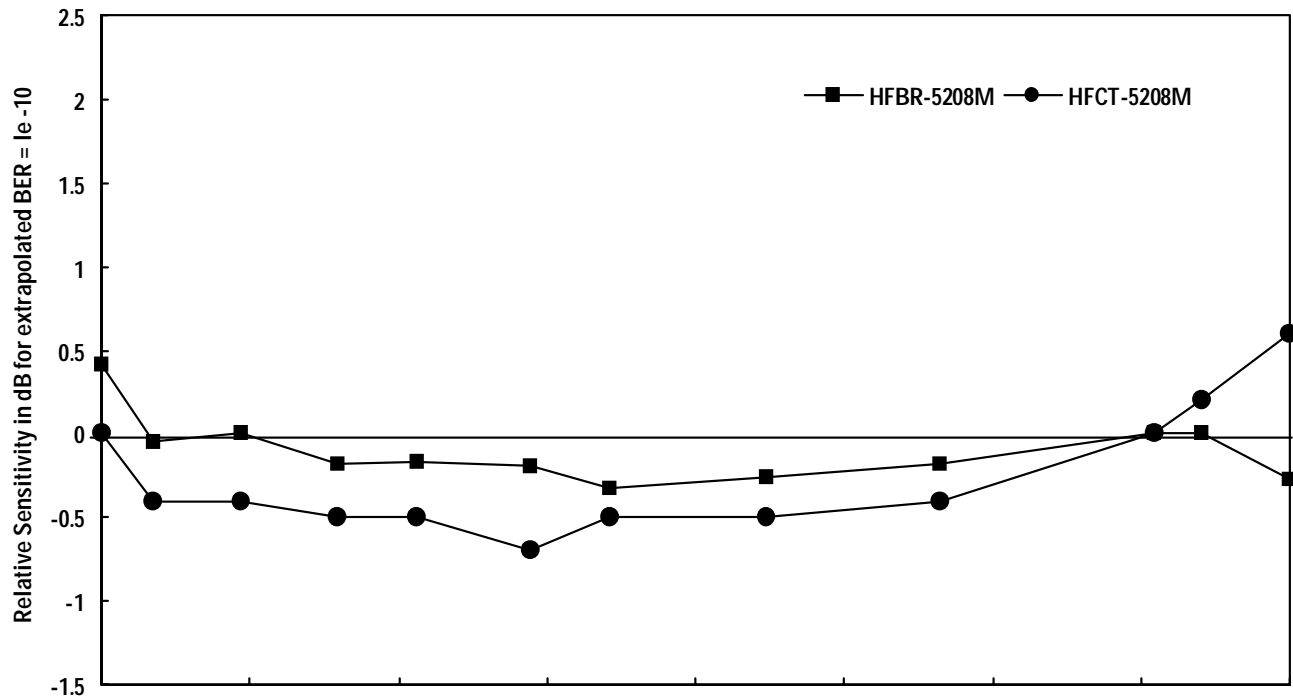

Figure 3. Relative Input Optical Power as a function of data rate normalized to center of Baud interval at 622 MBd. Test Conditions +25°C, 5.25V, PRBS2²³-1, optical $\tau_r/\tau_f=0.9$ ns with 3m of MMF for SMF.

Recommended Circuit Schematic

When designing the HFBR/HFCT-5208M circuit interface, there are a few fundamental guidelines to follow. For example, in the Recommended Circuit Schematic, Figure 4, the differential data lines should be treated as 50 ohm Microstrip or stripline transmission lines. This will help to minimize the parasitic inductance and capacitance effects. Proper termination of the differential data signal will prevent reflections and ringing which would compromise the signal fidelity and generate unwanted electrical noise. Locate termination at the received signal end of the transmission line. The length of these lines should be kept short and of equal length to prevent pulse-width distortion from occurring. For the high-speed signal lines, differential signals should be used, not single-ended signals. These differential signals need to be loaded symmetrically to prevent unbalanced currents from flowing which will cause distortion in the signal.

In addition to these recommendations, Avago Technologies' Application Engineering staff is available for consulting on best layout practices with various vendors' serializer/deserializer, clock recovery/generation integrated circuits.

Reference Design

Avago Technologies has developed a reference design for multimode and single-mode OC-12 ATM-SONET/SDH applications shown in Figure 6. This reference design uses a Vitesse Semiconductor Inc.'s VSC8117 clock recovery/clock generation/serializer/deserializer integrated circuit and a PMC-Sierra Inc. PM5355 framer IC. Application Note 1178 documents the design, layout, testing and performance of this reference design. Gerber files, schematic and application note are available from the Avago Technologies web site at the URL of <http://www.avagotech.com>

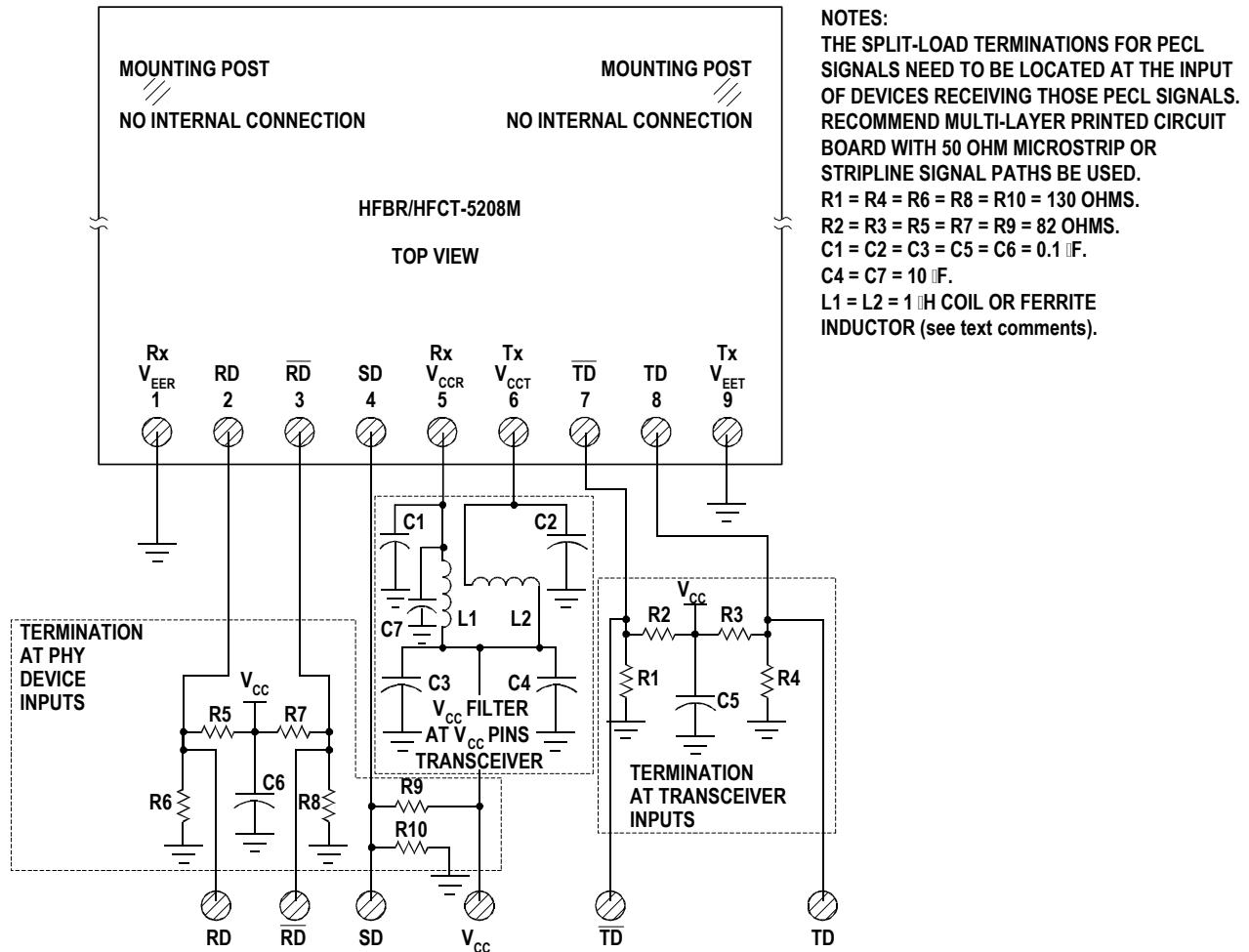

Figure 4. Recommended Circuit Schematic for dc Coupling (at +5 V) between Optical Transceiver and Physical Layer IC

Operation in -5.2 V Designs

For applications that require -5.2 V dc power supply level for true ECL logic circuits, the HFBR/HFCT-5208M transceiver can be operated with a $V_{CC} = 0$ V dc and a $V_{EE} = -5.2$ V dc. This transceiver is not specified with an operating, negative power supply voltage. The potential compromises that can occur with use of -5.2 V dc power are that the absolute voltage states for V_{OH} and V_{OL} will be changed slightly due to the 0.2 V difference in supply levels. Also, noise immunity may be compromised for the HFBR/HFCT-5208M transceiver because the ground plane is now the V_{CC} supply point. The suggested power supply filter circuit shown in the Recommended Circuit Schematic figure should be located in the V_{EE} paths at the transceiver supply pins. Direct coupling of the differential data signal can be done between the HFBR-5208M transceiver and the standard ECL circuits. For guaranteed -5.2 V dc operation, contact your local Avago Technologies Component Field Sales Engineer for assistance.

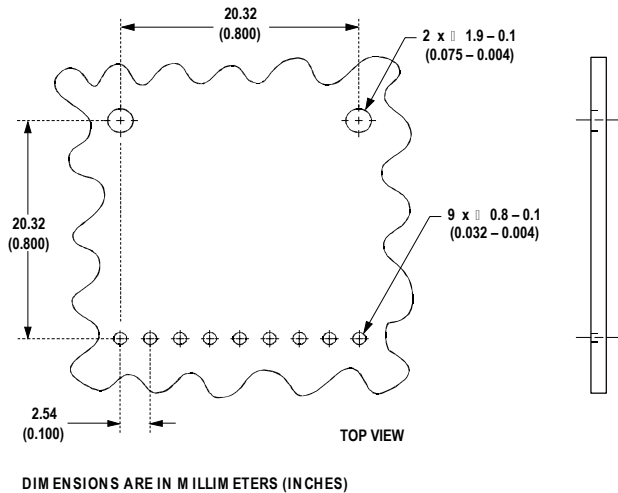

Figure 5. Recommended Board Layout Pattern

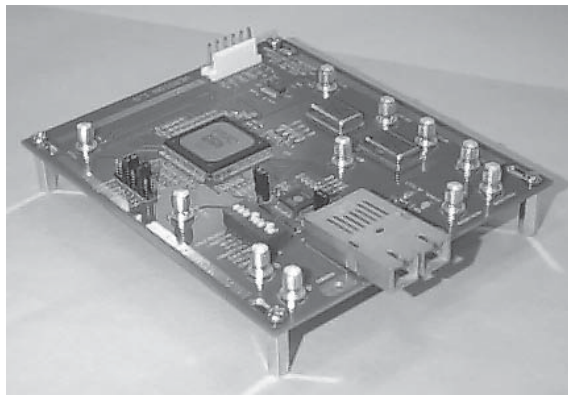

Figure 6. 622.08 Mb/s OC-12 ATM-SONET/SDH Reference Design Board

Electromagnetic Interference (EMI)

One of a circuit board designer's foremost concerns is the control of electromagnetic emissions from electronic equipment. Success in controlling generated Electromagnetic Interference (EMI) enables the designer to pass a governmental agency's EMI regulatory standard; and more importantly, it reduces the possibility of interference to neighboring equipment. There are three options available for the HFBR/HFCT-5208M with regard to EMI shielding for providing the designer with a means to achieve good EMI performance. The EMI performance of an enclosure using these transceivers is dependent on the chassis design. Avago Technologies encourages using standard RF suppression practices and avoiding poorly EMI-sealed enclosures. In addition, Avago Technologies advises that for the best EMI performance, the metalized case must be connected to chassis ground using one of the shield options.

HFBR/HFCT-5208EM transceiver beyond the front surface of the panel or enclosure is 6.35 mm (0.25 in). With this option, there is flexibility of positioning the module to fit the specific need of the enclosure design. (See Figure 8 for the mechanical drawing dimensions of this shield.)

The second shielded option, option FM, is for applications that are designed to have a flush mounting of the module with respect to the front of the panel or enclosure. The flush-mount design accommodates a large variety of panel thickness, i.e. 1.02 mm (.04 in) min to 2.54 mm (0.1 in) max. Note the reference plane for the flush-mount design is the interior side of the panel or enclosure. The recommended distance from the centerline of the transceiver front solder posts to the inside wall of the panel is 13.82 mm (0.544 in). This option contacts the inside panel or enclosure wall on all four sides of this metal shield. (See Figure 10 for the mechanical drawing dimensions of this shield.)

Both shielded design options connect only to the equipment chassis and not to the signal or logic ground of the circuit board within the equipment closure. The front panel aperture dimensions are recommended in Figures 9 and 11. When layout of the printed circuit board is done to incorporate these metal-shielded transceivers, keep the area on the printed circuit board directly under the external metal shield free of any components and circuit board traces. For additional EMI performance advantage, use duplex SC fiber-optic connectors that have low metal content inside the connector. This lowers the ability of the metal fiber-optic connectors to couple EMI out through the aperture of the panel or enclosure.

Recommended Solder and Wash Process

The HFBR/HFCT-5208M is compatible with industry-standard wave or hand solder processes.

HFBR-5000 Process Plug

The HFBR/HFCT-5208M transceiver is supplied with a process plug, the HFBR-5000, for protection of the optical ports with the Duplex SC connector receptacle. This process plug prevents contamination during wave solder and aqueous rinse as well as during handling, shipping or storage. It is made of high-temperature, molded, sealing material that will withstand +85°C and a rinse pressure of 110 lb/in².

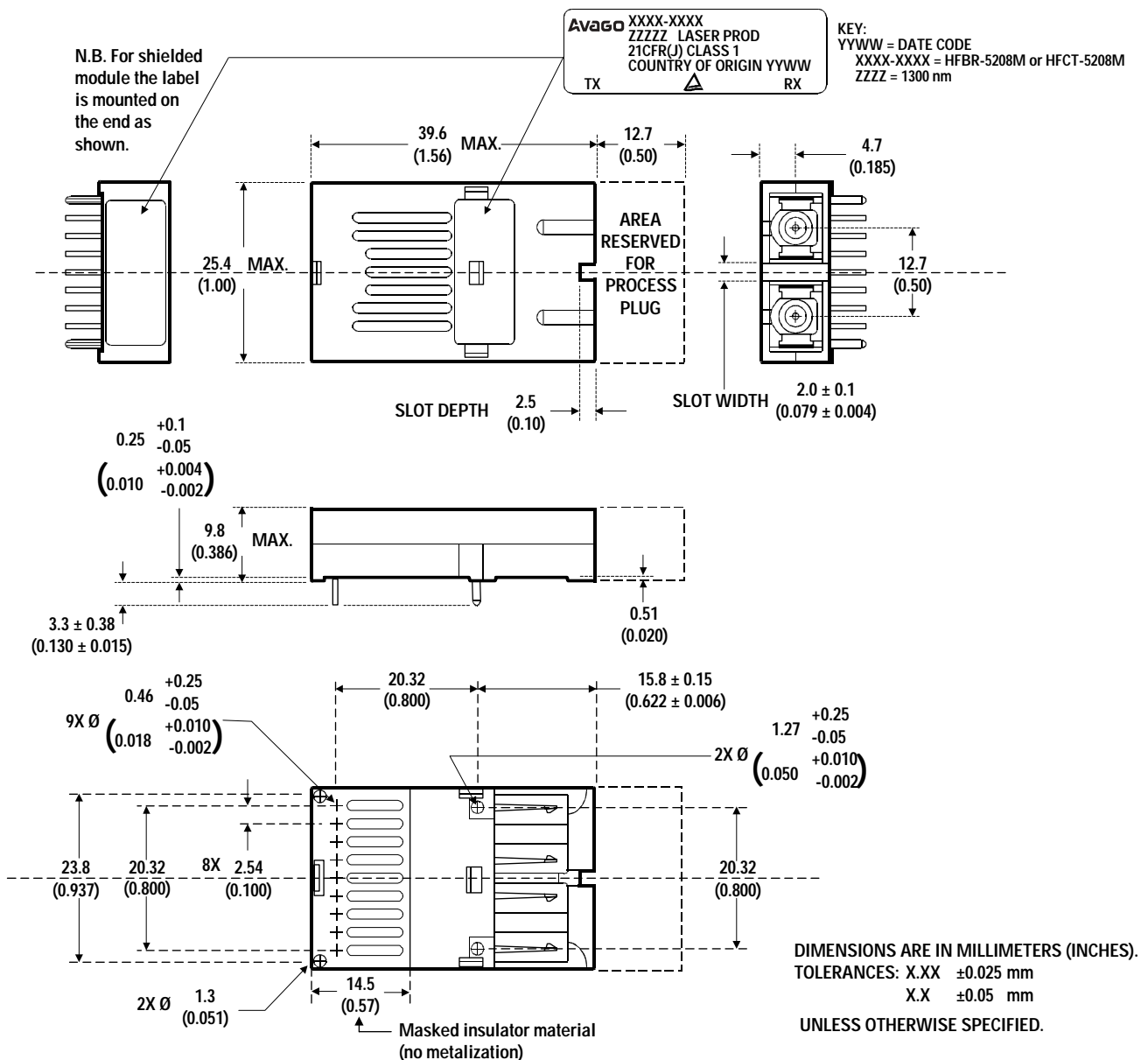

Figure 7. Package Outline Drawing for HFBR/HFCT-5208M

Recommended Solder Fluxes and Cleaning/Degreasing Chemicals

Recommended cleaning and degreasing chemicals for the HFBR/HFCT-5208M are alcohols (methyl, isopropyl, isobutyl), aliphatics (hexane, heptane) and other chemicals, such as soap solution or naphtha. Do not use partially halogenated hydrocarbons for cleaning/degreasing. Examples of chemicals to avoid are 1,1,1 trichloroethane, ketones (such as MEK), acetone, chloroform, ethyl acetate, methylene dichloride, phenol, methylene chloride or N methylpyrrolidone.

Regulatory Compliance

These transceiver products are intended to enable commercial system designers to develop equipment that complies with the various regulations governing certification of Information Technology Equipment. See the Regulatory Compliance Table for details. Additional information is available from your Avago Technologies sales representative.

Electrostatic Discharge (ESD)

There are two design cases in which immunity to ESD damage is important.

The first case is during handling of the transceiver prior to mounting it on the circuit board. It is important to use normal ESD handling precautions for ESD sensitive devices. These precautions include using grounded wrist straps, work benches, and floor mats in ESD controlled areas, etc.

The second case to consider is static discharges to the exterior of the equipment chassis containing the transceiver parts. To the extent that the duplex SC connector receptacle is exposed to the outside of the equipment chassis, it may be subject to whatever ESD system level test criteria that the equipment is intended to meet.

Electromagnetic Interference (EMI)

Most equipment designs utilizing these high-speed transceivers from Avago Technologies will be required to meet the requirements of FCC in the United States, CENELEC EN55022 (CISPR 22) in Europe and VCCI in Japan.

The HFBR/HFCT-5208M EMI has been characterized with a chassis enclosure to demonstrate the robustness of the parts. Performance of a system containing these transceivers will vary depending on the individual chassis design.

Immunity

Equipment utilizing these HFBR/HFCT-5208M transceivers will be subject to radio-frequency electromagnetic fields in some environments. These transceivers, with their integral shields, have been characterized without the benefit of a normal equipment chassis enclosure and the results are reported below. Performance of a system containing these transceivers within a well- designed chassis is expected to be better than the results of these tests without a chassis enclosure.

Eye Safety

The HFCT-5208M transceiver is classified as AEL Class I (U.S. 21 CFR(J) and AEL Class 1 per EN 60825-1 (+A11). It is eye safe when used within the data sheet limits per CDRH. It is also eye safe under normal operating conditions and under all reasonably foreseeable single fault conditions per EN60825-1. Avago Technologies has tested the transceiver design for compliance with the requirements listed below under normal operating conditions and under single fault conditions where applicable. TUV Rheinland has granted certification to this transceiver for laser eye safety and use in EN 60950 and EN 60825-2 applications.

Regulatory Compliance - Targeted Specifications

Feature	Test Method	Performance
Electrostatic Discharge (ESD)	MIL-STD-883C Method 3015.4	Min 2000 V
	Machine Model JEDEC JESD22-A115-A	Min 100 V
	RAD IEC-61000-4-2	Products of this design typically withstand 25 kV without damage.
Electromagnetic Interference (EMI)	FCC Class B CENELEC EN55022 Class B (CISPR 22B) VCCI Class 2	Margins are dependant on customer board and chassis design.
Immunity	Variation of IEC 801-3	Typically show no measurable effect from a 10 V/m field swept from 26 to 1000 MHz applied to the transceiver when mounted to a circuit card without a chassis enclosure.
QFBR-5322	Transmitter is Device is	

The HFBR-5208M LED and the HFCT-5208M Laser transmitters are classified as IEC 825-1 Accessible Emission Limit (AEL) Class 1. AEL Class 1 LED/Laser devices are considered eye safe.

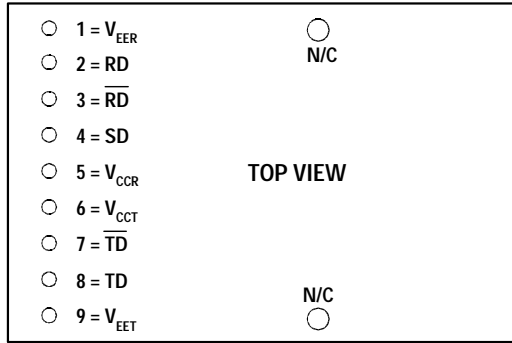

N/C = NO INTERNAL CONNECTION (MOUNTING POSTS) - CONNECT TO CHASSIS GROUND OR LEAVE FLOATING, DO NOT CONNECT TO SIGNAL GROUND.

Table 1. Pinout Table

Pin	Symbol	Functional Description
Mounting Studs		
The mounting studs are provided for transceiver mechanical attachment to the circuit boards, they are embedded in the metalized plastic housing and are not connected to the transceiver internal circuit. They should be soldered into plated-through holes on the printed circuit board and not connected to signal ground.		
1	V_{EER}	Receiver Signal Ground Directly connect this pin to receiver signal ground plane. Receiver V_{EER} and transmitter V_{EET} can connect to a common circuit board ground plane.
2	RD+	Receiver Data Out Terminate this high-speed, differential, PECL output with standard PECL techniques at the follow-on device input pin.
3	RD-	Receiver Data Out Bar Terminate this high-speed, differential, PECL output with standard PECL techniques at the follow-on device input pin.
4	SD	Signal Detect Normal input optical signal levels to the receiver result in a logic "1" output (V_{OH}). Low input optical signal levels to the receiver result in a fault condition indication shown by a logic "0" output (V_{OL}). If Signal Detect output is not used, leave it open-circuited. This Signal Detect output can be used to drive a PECL input on an upstream circuit, such as, Signal Detect input or Loss of Signal-bar.
5	V_{CCR}	Receiver Power Supply Provide +5 V dc via the recommended receiver V_{CCR} power supply filter circuit. Locate the power supply filter circuit as close as possible to the V_{CCR} pin.
6	V_{CCT}	Transmitter Power Supply Provide +5 V dc via the recommended transmitter V_{CCT} power supply filter circuit. Locate the power supply filter circuit as close as possible to the V_{CCT} pin.
7	TD-	Transmitter Data In Bar Terminate this high-speed, differential, Transmitter Data input with standard PECL techniques at the transmitter input pin.
8	TD+	Transmitter Data In Terminate this high-speed, differential, Transmitter Data input with standard PECL techniques at the transmitter input pin.
9	V_{EET}	Transmitter Signal Ground Directly connect this pin to the transmitter signal ground plane. Transmitter V_{EET} and receiver V_{EER} can connect to a common circuit board ground plane.

Absolute Maximum Ratings

Stresses in excess of the absolute maximum ratings can cause catastrophic damage to the device. Limits apply to each parameter in isolation, all other parameters having values within the recommended operating conditions. It should not be assumed that limiting values of more than one parameter can be applied to the product at the same time. Exposure to the absolute maximum ratings for extended periods can adversely affect device reliability.

Parameter	Symbol	Minimum	Typical	Maximum	Unit	Notes
Storage Temperature	T_S	-40		+85	°C	
Lead Soldering Temperature - HFBR-5208M	T_{SOLD}			+260	°C	
Lead Soldering Time	t_{SOLD}			10	sec.	
Supply Voltage	V_{CC}	-0.5		6.0	V	
Data Input Voltage	V_I	-0.5		V_{CC}	V	
Transmitter Differential Input Voltage	V_D			1.6	V	1
Output Current	I_D			50	mA	
Relative Humidity	RH	0		95	%	

Recommended Operating Conditions

Parameter	Symbol	Minimum	Typical	Maximum	Unit	Notes
Ambient Operating Temperature QFBR-5322	T_A	0		+70	°C	2
Ambient Operating Temperature QFBR-5322	T_A	-40		+85	°C	2
Supply Voltage	V_{CC}	4.75		5.25	V	
Power Supply Rejection	PSR		100		mV p-p	3
Transmitter Data Input Voltage - Low	$V_{IL}-V_{CC}$	-1.810		-1.475	V	4
Transmitter Data Input Voltage - High	$V_{IH}-V_{CC}$	-1.165		-0.880	V	4
Transmitter Differential Input Voltage	V_D	0.3		1.6	V	
Data Output Load	R_{DL}		50		W	5
Signal Detect Output Load	R_{SDL}		50		W	5

Notes:

1. This is the maximum voltage that can be applied across the Differential Transmitter Data Inputs without damaging the ESD protection circuit.
2. 2 ms^{-1} air flow required (for HFCT-5208xxM only).
3. Tested with a 100 mV p-p sinusoidal signal in the frequency range from 500 Hz to 1 MHz imposed on the V_{CC} supply with the recommended power supply filter in place, see Figure 4. Typically less than a 0.5 dB change in sensitivity is experienced.
4. Compatible with 10K, 10KH and 100K ECL and PECL output signals.
5. The outputs are terminated to $V_{CC} - 2\text{ V}$.

HFBR-5208M Family, 1300 nm LED

Transmitter Electrical Characteristics

($T_A = 0^\circ\text{C}$ to $+70^\circ\text{C}$, $V_{CC} = 4.75$ to 5.25 V. Typical @ $+25^\circ\text{C}$, 5 V)

($T_A = -40^\circ\text{C}$ to $+85^\circ\text{C}$, $V_{CC} = 4.75$ to 5.25 V. Typical @ $+25^\circ\text{C}$, 5 V for A specification part)

Parameter	Symbol	Minimum	Typical	Maximum	Unit	Notes
Supply Current	I_{CCT}		155	200	mA	1
Power Dissipation	P_{DIST}		0.75	1.05	W	
Data Input Current - Low	I_{IL}	-350			μA	
Data Input Current -High	I_{IH}			350	μA	

Receiver Electrical Characteristics

($T_A = 0^\circ\text{C}$ to $+70^\circ\text{C}$, $V_{CC} = 4.75$ to 5.25 V. Typical @ $+25^\circ\text{C}$, 5 V)

($T_A = -40^\circ\text{C}$ to $+85^\circ\text{C}$, $V_{CC} = 4.75$ to 5.25 V. Typical @ $+25^\circ\text{C}$, 5 V for A specification part)

Parameter	Symbol	Minimum	Typical	Maximum	Unit	Notes
Supply Current	I_{CCR}		112	177	mA	
Power Dissipation	P_{DISR}		0.37	0.77	W	2
Data Output Voltage - Low	$V_{OL} - V_{CC}$	-1.950	-1.82	-1.620	V	3
Data Output Voltage - High	$V_{OH} - V_{CC}$	-1.045	-0.94	-0.740	V	3
Data Output Rise Time	t_R	0.2	0.3	0.51	ns	4
Data Output Fall Time	t_F	0.2	0.3	0.51	ns	4
Signal Detect Output Voltage - Low	$V_{OL} - V_{CC}$	-1.950	-1.82	-1.620	V	3
Signal Detect Output Voltage - High	$V_{OH} - V_{CC}$	-1.045	-0.94	-0.740	V	3
Signal Detect Assert Reaction Time (Off to On)	t_{SDA}		35	100	μs	5
Signal Detect Deassert Reaction Time (On to Off)	t_{SDD}		60	350	μs	6

Notes:

1. The I_{CC} value is held nearly constant to minimize unwanted electrical noise from being generated and conducted or emitted to neighboring circuitry.
2. Power dissipation value is the power dissipated in the receiver itself. It is calculated as the sum of the products of V_{CC} and I_{CC} minus the sum of the products of the output voltages and load currents.
3. These outputs are compatible with 10K, 10KH and 100K ECL and PECL inputs.
4. These are 20% - 80% values.
5. The Signal Detect output will change from logic "V_{OL}" to "V_{OH}" within 100 μs of a step transition in input optical power from no light to -26 dBm.
6. The Signal Detect output will change from logic "V_{OH}" to "V_{OL}" within 350 μs of a step transition in input optical power from -26 dBm to no light.

HFBR-5208M Family, 1300 nm LED

Transmitter Optical Characteristics

($T_A = 0^\circ\text{C}$ to $+70^\circ\text{C}$, $V_{CC} = 4.75$ to 5.25 V. Typical @ $+25^\circ\text{C}$, 5 V)

($T_A = -40^\circ\text{C}$ to $+85^\circ\text{C}$, $V_{CC} = 4.75$ to 5.25 V. Typical @ $+25^\circ\text{C}$, 5 V for A specification part)

Parameter	Symbol	Minimum	Typical	Maximum	Unit	Notes
Output Optical Power 62.5/125 μm . NA = 0.275 fiber	P_0 (BOL) P_0 (EOL)	-19.5 -20	-17	-14 -14	dBm avg.	
Output Optical Power 50/125 μm . NA = 0.20 fiber	P_0 (BOL) P_0 (EOL)		-21.5 -22	-14 -14		7
Output Optical Power at Logic "0" State	P_0 ("0")		-60		dBm avg.	
Optical Extinction Ratio	ER	10	46		dB	
Center Wavelength	λ_c	1270	1330	1380	nm	
Spectral Width - FWHM	s		136	200	nm	8
Optical Rise Time	t_R		0.7	1.25	ns	9
Optical Fall Time	t_F		0.9	1.25	ns	9
Overshoot			0	25	%	
Systematic Jitter Contributed by the Transmitter	SJ		0.04	0.23	ns p-p	
Random Jitter Contributed by the Transmitter	RJ		0.0	0.10	ns p-p	

Notes:

- The Output Optical Power is measured with the following conditions:
 - 1 meter of fiber with cladding modes removed.
 - The input electrical signal is a 12.5 MHz square wave.
 - The Beginning of Life (BOL) to End of Life (EOL) degradation is less than 0.5 dB.
- The relationship between FWHM and RMS values for spectral width can be derived from the assumption of a Gaussian-shaped spectrum which results in $\text{RMS} = \text{FWHM}/2.35$.
- These are 10-90% values.

HFBR-5208M Family, 1300 nm LED

Receiver Optical Characteristics

($T_A = 0^\circ\text{C}$ to $+70^\circ\text{C}$, $V_{CC} = 4.75$ to 5.25 V. Typical @ $+25^\circ\text{C}$, 5 V)

($T_A = -40^\circ\text{C}$ to $+85^\circ\text{C}$, $V_{CC} = 4.75$ to 5.25 V. Typical @ $+25^\circ\text{C}$, 5 V for A specification part)

Parameter	Symbol	Minimum	Typical	Maximum	Unit	Notes
Minimum Input Optical Power at window edge	$P_{IN\ MIN}$ (W)		-29.0	-26	dBm avg.	10 Fig 2
Minimum Input Optical Power at eye center	$P_{IN\ MIN}$ (C)		-30.5		dBm avg.	10 Fig 2,3
Input Optical Power Maximum	$P_{IN\ MAX}$	-14	-11		dBm avg.	10
Input Operating Wavelength	λ	1270		1380	nm	
Systematic Jitter Contributed by the Receiver	SJ		0.1	0.30	ns p-p	
Random Jitter Contributed by the Receiver	RJ		0.25	0.48	ns p-p	
Signal Detect - Asserted	P_A	$P_D + 1.0$ dB	-30.5	-28	dBm avg.	
Signal Detect - Deasserted	P_D	-45	-33.7		dBm avg.	
Signal Detect - Hysteresis	$P_A - P_D$	1.0	3.2	5	dB	

Notes:

- This specification is intended to indicate the performance of the receiver section of the transceiver when the input power ranges from the minimum level (with a window time-width) to the maximum level. Over this range the receiver is guaranteed to provide output data with aBit Error Ratio (BER) better than or equal to 1×10^{-10}
 - At the Beginning of Life (BOL)
 - Over the specified operating temperature and voltage ranges
 - Input is at 622.08 Mbd, 2²³-1 PRBS data pattern with 72 "1"s and 72 "0"s inserted per the CCITT (now ITU-T) recommendation G.958 Appendix 1.
 - Receiver worst-case output data eye-opening (window time-width) is measured by applying worst-case input systematic (SJ) and randomjitter (RJ). The worst-case maximum input SJ = 0.5 ns peak-to-peak and the RJ = 0.15 ns peak-to-peak per ANSI T1.646a standard. Since the input (transmitter) random jitter contribution is very small and difficult to produce exactly, only the maximum systematic jitter is produced and used for testing the receiver. The corresponding receiver test window time-width must meet the requirement of 0.31 ns or larger. This worst-case test window time-width results from the following jitter equation:
Minimum Test Window Time-Width = Baud Interval - Tx SJ max. - Rx SJ max. - Rx RJ max.
Respectively, Minimum Test Window Time-Width = 1.608 ns - 0.50 ns - 0.30 ns - 0.48 ns = 0.328 ns.
This is a test method that is within practical test error of the worst-case 0.31 ns limit.
 - Input optical rise and fall times (10% - 90%) are 0.7 ns and 0.9 ns respectively.
 - Transmitter operating with a 622.08 MBd, 311.04 MHz square wave input signal to simulate any cross talk present between the transmitter and receiver sections of the transceiver.

HFCT-5208M Family, 1300 nm FP Laser

Transmitter Electrical Characteristics

($T_A = 0^\circ\text{C}$ to $+70^\circ\text{C}$, $V_{CC} = 4.75$ to 5.25 V. Typical @ $+25^\circ\text{C}$, 5 V)

($T_A = -40^\circ\text{C}$ to $+85^\circ\text{C}$, $V_{CC} = 4.75$ to 5.25 V. Typical @ $+25^\circ\text{C}$, 5 V for A specification part)

Parameter	Symbol	Minimum	Typical	Maximum	Unit	Notes
Supply Current	I_{CCT}		47	140	mA	1
Power Dissipation	P_{DIST}		0.235	0.75	W	
Data Input Current - Low	I_{IL}	-350			μA	
Data Input Current -High	I_{IH}			350	μA	

Receiver Electrical Characteristics

($T_A = 0^\circ\text{C}$ to $+70^\circ\text{C}$, $V_{CC} = 4.75$ to 5.25 V. Typical @ $+25^\circ\text{C}$, 5 V)

($T_A = -40^\circ\text{C}$ to $+85^\circ\text{C}$, $V_{CC} = 4.75$ to 5.25 V. Typical @ $+25^\circ\text{C}$, 5 V for A specification part)

Parameter	Symbol	Minimum	Typical	Maximum	Unit	Notes
Supply Current	I_{CCR}		130	150	mA	1, 2
Power Dissipation	P_{DISR}		0.65	0.787	W	
Data Output Voltage - Low	$V_{OL} - V_{CC}$	-1.950		-1.620	V	3
Data Output Voltage - High	$V_{OH} - V_{CC}$	-1.045		-0.740	V	3
Data Output Rise Time	t_R		0.5		ns	4
Data Output Fall Time	t_F		0.5		ns	4
Signal Detect Output Voltage - Low	$V_{OL} - V_{CC}$	-1.950		-1.620	V	3
Signal Detect Output Voltage - High	$V_{OH} - V_{CC}$	-1.045		-0.740	V	3
Signal Detect Assert Reaction Time (Off to On)	t_{SDA}		25	100	μs	5
Signal Detect Deassert Reaction Time (On to Off)	t_{SDD}		80	100	μs	6

Notes:

1. The power supply current varies with temperature. Maximum current is specified at $V_{CC} = \text{Maximum}$ @ maximum temperature (not including termination currents) and end of life.
2. The current excludes the output load current.
3. These outputs are compatible with 10K, 10KH and 100K ECL and PECL inputs.
4. These are 20% - 80% values.
5. The Signal Detect output will change from logic "V_{OL}" to "V_{OH}" within 100 μs of a step transition in input optical power from no light to -28 dBm.
6. The Signal Detect output will change from logic "V_{OH}" to "V_{OL}" within 100 μs of a step transition in input optical power from -28 dBm to no light.

HFCT-5208M Family, 1300 nm FP Laser

Transmitter Optical Characteristics

($T_A = 0^\circ\text{C}$ to $+70^\circ\text{C}$, $V_{CC} = 4.75$ to 5.25 V. Typical @ $+25^\circ\text{C}$, 5 V)

($T_A = -40^\circ\text{C}$ to $+85^\circ\text{C}$, $V_{CC} = 4.75$ to 5.25 V. Typical @ $+25^\circ\text{C}$, 5 V for A specification part)

Parameter	Symbol	Minimum	Typical	Maximum	Unit	Notes
Output Optical Power	P_0	-15	-11	-8	dBm avg.	7
Optical Extinction Ratio	ER	8.2	13.8		dB	
Center Wavelength	λ_c	1274	1313	1356	nm	
Spectral Width - (RMS)	s		1.1	2.5	nm	
Output Optical Eye Opening	Compliant with Bellcore TR-NWT-000253 and ITU-T recommendation G.957.					

Receiver Optical Characteristics

($T_A = 0^\circ\text{C}$ to $+70^\circ\text{C}$, $V_{CC} = 4.75$ to 5.25 V. Typical @ $+25^\circ\text{C}$, 5 V)

($T_A = -40^\circ\text{C}$ to $+85^\circ\text{C}$, $V_{CC} = 4.75$ to 5.25 V. Typical @ $+25^\circ\text{C}$, 5 V for A specification part)

Parameter	Symbol	Minimum	Typical	Maximum	Unit	Notes
Minimum Input Optical Power	$P_{IN\ MIN}$		-32	-28	dBm	8
Maximum Input Optical Power	$P_{IN\ MAX}$	-7			dBm	8
Signal Detect - Asserted	P_A	-42	-39	-31	dBm	
Signal Detect - Hysteresis	$P_A - P_D$	0.5	1.2	4.0	dB	9,10

Notes:

7. The output power is coupled into a 1 m single-mode fiber. Minimum output optical level is at end of life.
8. Minimum sensitivity and saturation levels for 2²³-1 PRBS with 72 ones and 72 zeros inserted. (ITU-T recommendation G.958). Sensitivity is measured for a BER of 10⁻¹⁰ at center of Baud interval with the transmitter powered up to test for crosstalk between the transmitter and receiver sections of the transceiver.
9. The Bit Error Rate (BER) measurements are not performed but a high to low transition in SD typically occurs at a receiver BER of 10⁻⁶ or worse.
10. For HFCT-5208Axx (extended temperature) Signal Detect - Hysteresis: 0.3 dB minimum.

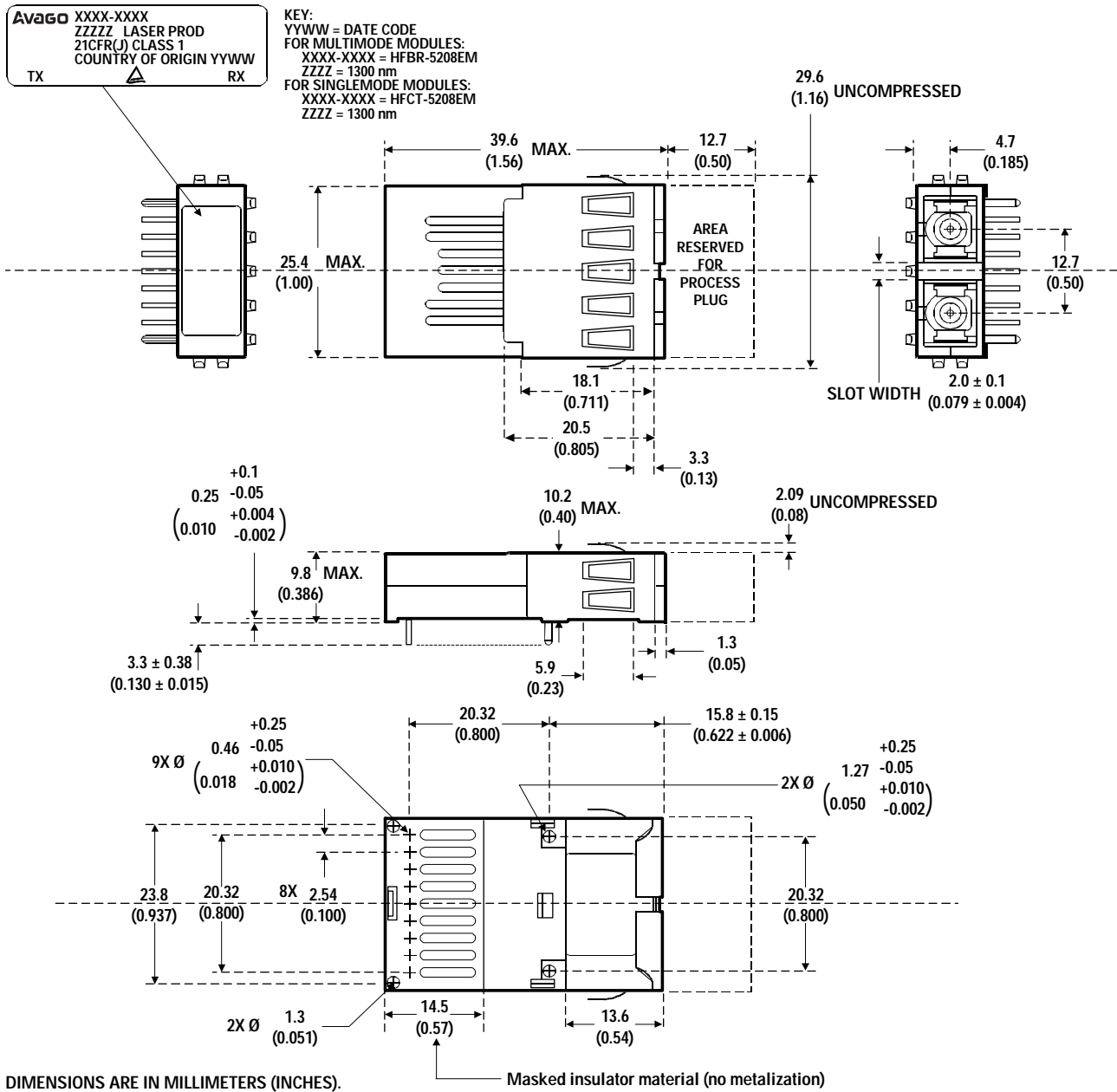

DIMENSIONS ARE IN MILLIMETERS (INCHES).
 TOLERANCES: X.XX ±0.025 mm UNLESS OTHERWISE SPECIFIED.
 X.X ±0.05 mm

Figure 8. Package Outline for HFBR/HFCT-5208EM

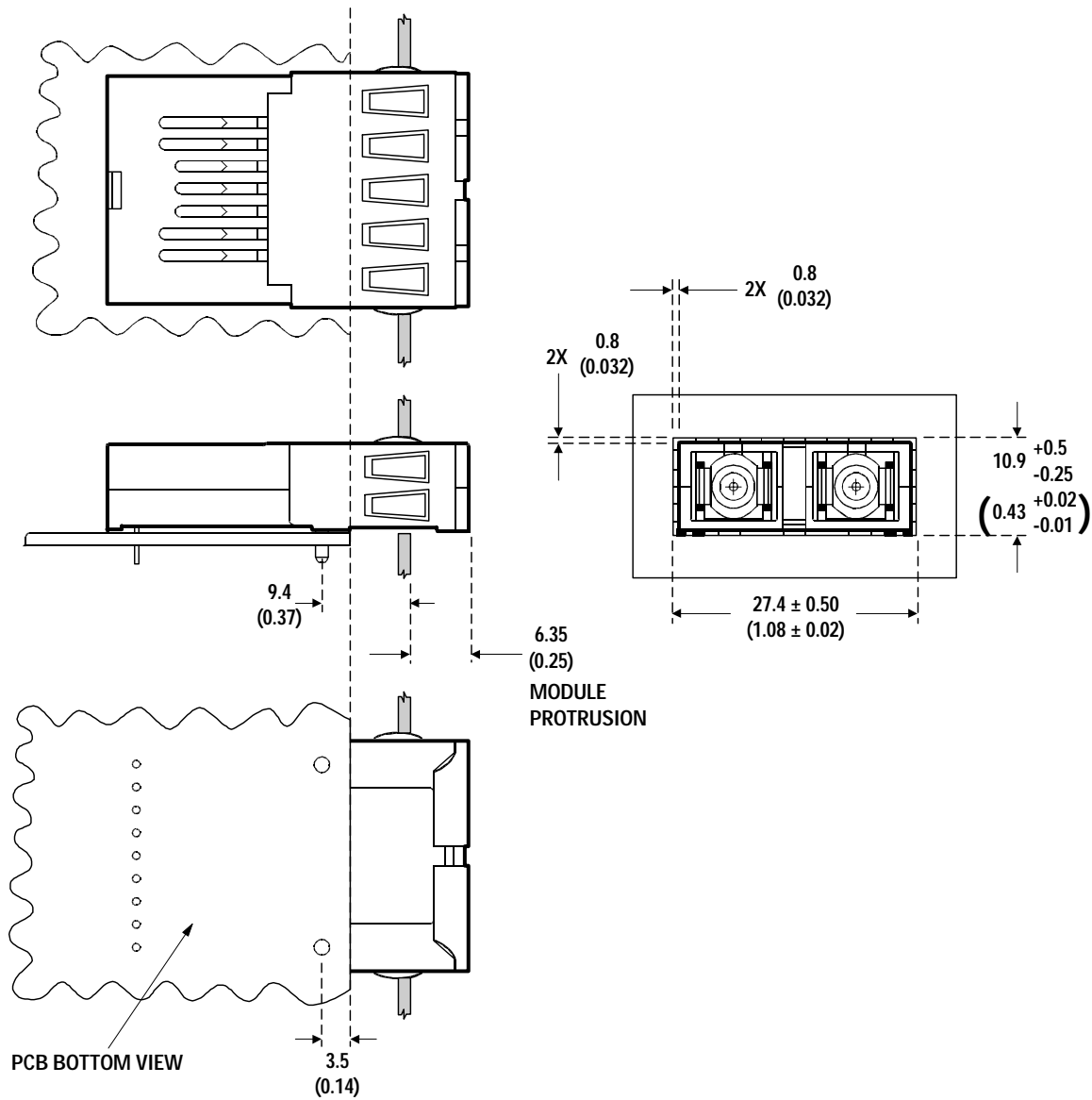

DIMENSIONS ARE IN MILLIMETERS (INCHES).
 TOLERANCES: X.XX ±0.025 mm UNLESS OTHERWISE SPECIFIED.
 X.X ±0.05 mm

Figure 9. Suggested Module Positioning and Panel Cut-out for HFBR/HFCT-5208EM

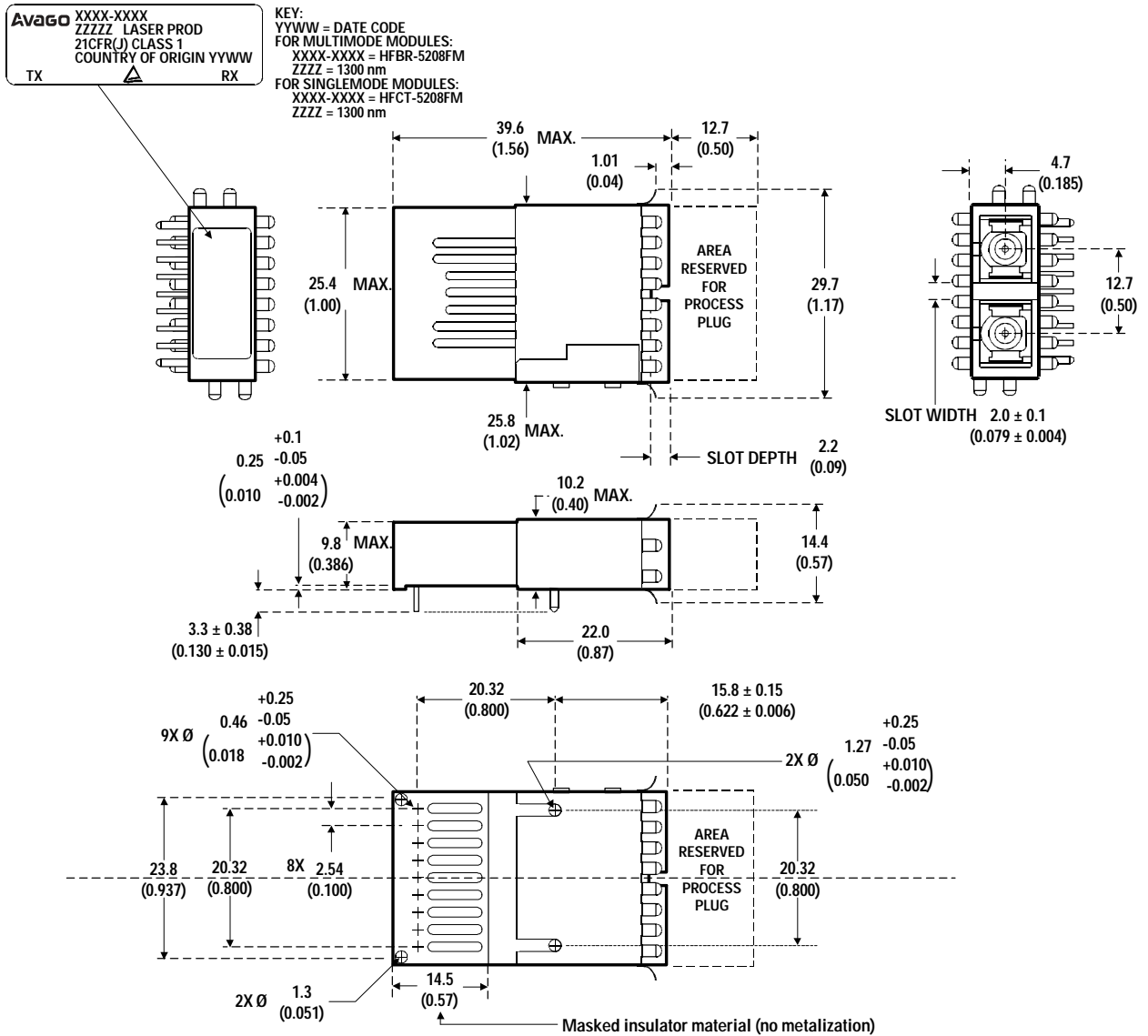

DIMENSIONS ARE IN MILLIMETERS (INCHES).
TOLERANCES: X.XX ±0.025 mm UNLESS OTHERWISE SPECIFIED.
X.X ±0.05 mm

Figure 10. Package Outline for HFBR/HFCT-5208FM

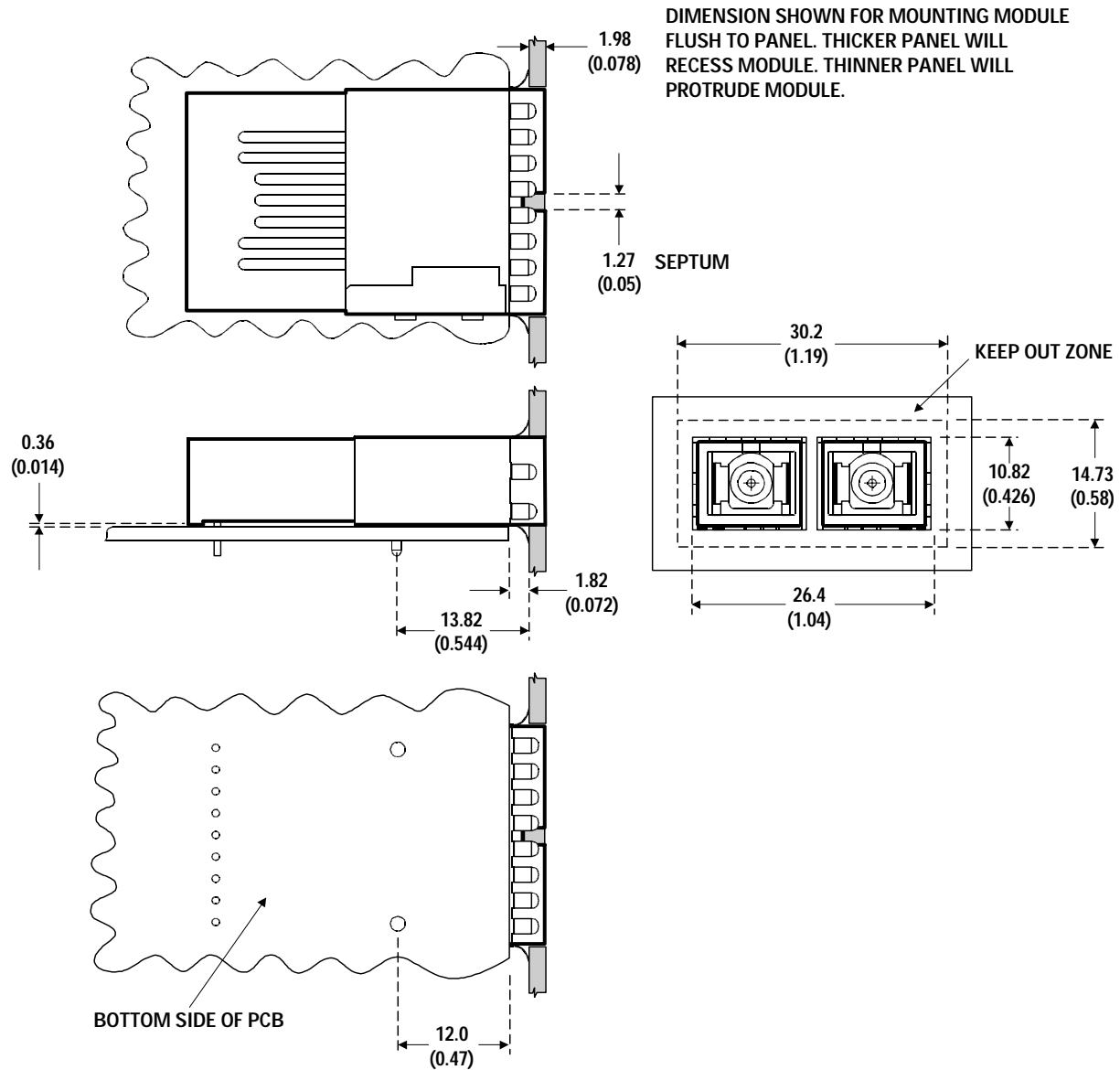

DIMENSIONS ARE IN MILLIMETERS (INCHES).
 TOLERANCES: X.XX ±0.025 mm UNLESS OTHERWISE SPECIFIED.
 X.X ±0.05 mm

Figure 11. Suggested Module Positioning and Panel Cut-out for HFBR/HFCT-5208FM

Ordering Information

1300 nm LED (temperature range 0°C to +70°C)

HFBR-5208M	No shield, metallized housing.
HFBR-5208EM	Extended/protruding shield, metallized housing.
HFBR-5208FM	Flush shield, metallized housing.

1300 nm LED (temperature range -40°C to +85°C)

HFBR-5208AM	No shield, metallized housing.
HFBR-5208AEM	Extended/protruding shield, metallized housing.
HFBR-5208AFM	Flush shield, metallized housing.

1300 nm FP Laser (temperature range 0°C to +70°C)

HFCT-5208M	No shield, metallized housing.
HFCT-5208EM	Extended/protruding shield, metallized housing.
HFCT-5208FM	Flush shield, metallized housing.

1300 nm FP Laser (temperature range -40°C to +85°C)

HFCT-5208AM	No shield, metallized housing.
HFCT-5208AEM	Extended/protruding shield, metallized housing.
HFCT-5208AFM	Flush shield, metallized housing.

Supporting Documentation

HFBR-5208M/HFCT-5208M	Application Note
HFBR-5208xx/HFCT-5208xx (0°C to +70°C)	Characterization Report
HFBR-5208Axx (-40°C to +85°C)	Characterization Report
HFCT-5208Axx (-40°C to +85°C)	Characterization Report
HFCT-5208M/HFCT-5218M	Qualification Report
HFBR-5208M	Qualification Report
HFBR-5208M/HFCT-5208M/HFCT-5218M	Reference Design Application Note 1178

For product information and a complete list of distributors, please go to our web site: www.avagotech.com

Avago, Avago Technologies, and the A logo are trademarks of Avago Technologies, Limited in the United States and other countries. Data subject to change. Copyright © 2006 Avago Technologies Limited. All rights reserved. Obsoletes 5988-2479EN 5988-2916EN - December 5, 2006

