

## *TABLE of CONTENTS*

### **ISOLATION TRANSFORMERS**

#### **10BASE-T FOR ADAPTER CARDS, MAUS, HUBS AND MOTHERBOARD APPLICATIONS**

Electrical Specifications: Surface Mount and Through Hole .....2

#### **ETHERNET AUI TRANSFORMERS**

Electrical Specifications: Surface Mount and Through Hole .....3

#### **APPLICATION CIRCUITS**

10Base-T .....4

Ethernet .....5

**SCHEMATICS** .....6

#### **MECHANICALS**

Surface Mount .....8

Through Hole .....10

# ISOLATION TRANSFORMERS FOR 10BASE-T

## For Adapter Cards, MAUs, Hubs, and Motherboard Applications

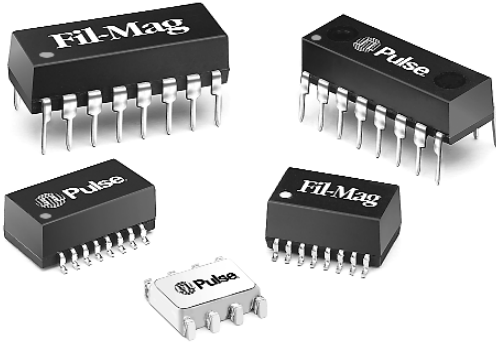

- ⊕ For RoHS part add suffix **NL**<sup>4</sup>
- ⊕ RoHS “**NL**” peak solder rating 260°C, non-RoHS peak solder rating 235°C
- ⊕ Meets IEEE 802.3 specification
- ⊕ Available with common mode chokes for EMI suppression
- ⊕ Through hole, auto-insertable, 16-pin DIP package

### Electrical Specifications @ 25°C — Operating Temperature 0°C to 70°C

Part Number	RoHS <sup>4</sup>	Turns Ratio (±5%)		Primary Pins	Common Mode Choke	Sine Wave Inductance OCL <sup>1</sup> (μH MIN)	Interwinding Capacitance C <sub>ww</sub> <sup>1</sup> (pF MAX)	Leakage Inductance L <sub>L</sub> <sup>1</sup> (μH MAX)	DCR (Ω MAX)	Hipot (Vrms)	Schem.	Mech.	
		Transmit	Receive										
<b>SURFACE MOUNT<sup>2</sup></b>												pages 6-7	pages 8-9
23Z114SM	5, 6c	1CT:1CT	1CT:1CT	1-3/6-8		200	12	0.3	0.3	2000	T4	SMT5	
23Z128SM	5, 6c	1CT:1.414CT	1CT:1CT	6-8/1-3		200	15	0.5	0.4	2000	T4	SMT5	
23Z356SM	5, 6c	1CT:1.414CT	1CT:1CT	6-8/1-3	X	200	12	0.5	0.6	2000	T7	SMT5	
23Z435SM	5, 6c	2CT:1CT	1CT:1CT	1-3/6-8		100	10	0.4	0.5	2000	T4	SMT5	
23Z467SM	5, 6c	1CT:2CT	1CT:1CT	6-8/1-3	X	140	12	0.2	0.6	2000	T7	SMT5	
E2023	NL <sup>6a</sup>	1CT: 2.5CT	1CT: 1CT	6-8/1-3	X	200	15	0.5	0.4	2000	T10	SMT4	
E4001	5, 6c	1CT:2CT	1CT:1CT	6-8/1-3	X	112	8	0.3	0.8	3000	T5	SMT4	
E4005	5, 6c	1CT: 2.5CT	1CT: 1CT	6-8/1-3	X	200	10	0.4	0.5	1500	T10	SMT4	
E5017	5, 6c	1CT:1CT	1CT:1CT	1-3/6-8	X	200	10	0.25	1.0	1500	T6	SMT4	
EX2024 <sup>3</sup>	5, 6a	1CT: 2.5CT	1CT:1CT	6-8/1-3	X	350	30	0.8	0.6	2000	T10	SMT4	
PE-65454	5, 6a	1:1.414	1:1	3-4/1-2		140	12	0.2	0.4	2000	T1	SMT2	
PE-65726	5, 6c	1CT:1CT	1CT:1CT	1-3/6-8		200	10	0.2	0.3	2000	T4	SMT4	
PE-65745	5, 6c	1CT: 1.414CT	1CT:1CT	6-8/1-3		140	12	0.2	0.3	2000	T4	SMT4	
PE-68023	5, 6c	1CT:2CT	1CT:1CT	1-3/6-8	X	200	12	0.3	1.0	1500	T6	SMT4	
PE-68041	5, 6c	1CT:2CT	1CT:1CT	6-8/1-3		112	8	0.3	0.5	1500	T4	SMT4	
PE-68042	5, 6c	2.828CT:1	1:1	2-4/7-9		200	14	1	0.5	1500	T9	SMT1	
PE-68048	5, 6c	1CT: 1.414CT	1CT:1CT	6-8/1-3	X	110	15	0.4	1.0	1500	T5	SMT4	
PE-68052	5, 6c	2CT:1CT	1CT:1CT	1-3/6-8	X	140	12	0.3	1.0	1500	T6	SMT4	
PE-68810	5, 6c	—	1:1 (4X)	1-2/3-4		140	12	0.2	0.4	2000	T3	SMT4	
PE-68820	5, 6c	1:1.414 (4X)	—	1-2/3-4 5-6/7-8		140	12	0.2	0.4	2000	T3	SMT4	
<b>THROUGH HOLE</b>												pages 6-7	page 10
23Z128	5, 6a	1CT: 2CT	1CT:1CT	6-8/1-3		140	15	0.5	0.4	2000	T4	TH3	
23Z435	5, 6a	2CT:1CT	1CT:1CT	1-3/6-8		80	10	0.4	0.5	2000	T4	TH3	
PE-65263	5, 6a	1CT:1CT	1CT:1CT	1-3/6-8		200	15	0.25	0.3	2000	T4	TH4	

#### NOTES:

1. OCL, C<sub>ww</sub> and L<sub>L</sub> are measured at 20 mVrms, 100 kHz.
2. For Tape & Reel packaging, add a suffix “T” to the end of the part number when ordering. e.g. E2023T.
3. Part numbers denoted “EX” are extended temperature parts -40°C to 85°C, electrical specifications @ 25°C.
4. Add suffix **NL** for RoHS compliant parts, e.g: E2023 changes to E2023**NL** or E2023**NLT** (for Tape & Reel).
5. Contact Pulse for RoHS compliant part availability.
6. MSL=Moisture Sensitivity Level a=1 b=2 c=3 d=4 e=5.

# ISOLATION TRANSFORMERS FOR ETHERNET AUI Transformers

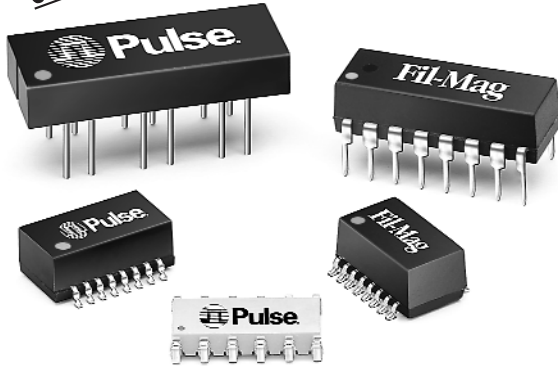

- ⊕ For RoHS part add suffix **NL**<sup>4</sup>
- ⊕ RoHS “NL” peak solder rating 260°C, non-RoHS peak solder rating 235°C
- ⊕ Low leakage inductance and coupling capacitance for faster rise times
- ⊕ Small form factor, 50 mil lead spacing
- ⊕ Through hole, auto-insertable, 16-pin DIP package

## Electrical Specifications @ 25°C — Operating Temperature 0°C to 70°C

Part <sup>3</sup> Number	RoHS <sup>4</sup>	Turns Ratio (±5%)	Primary Pins	Primary Sine Wave OCL <sup>1</sup> (μH ±20%)	Primary ET-Constant (V-μs MIN)	Rise Time <sup>2</sup> (ns MAX)	Interwinding Capacitance C <sub>ww</sub> <sup>1</sup> (pF MAX)	Leakage Inductance L <sub>L</sub> <sup>1</sup> (μH MAX)	DCR (Ω MAX)	Schem.	Mech.	Hipot (Vrms)	
<b>SURFACE MOUNT<sup>3</sup></b>												pages 6-7	pages 8-9
23Z90SM	5, 6c	1:1	1-2/4-5/7-8	75	2.4	3.0	10	0.20	0.20	T2	SMT5	2000	
23Z91SM	5, 6c	1:1	1-2/4-5/7-8	100	2.4	3.0	10	0.20	0.30	T2	SMT5	2000	
23Z108SM	5, 6c	1:1	1-2/4-5/7-8	350	2.5	3.5	16	0.30	0.35	T2	SMT5	2000	
E6002	5, 6c	1:1	1-2/4-5/7-8	40 (MIN)	2.1	3.0	8	0.20	0.25	T2	SMT4	2000	
PE-65723	5, 6c	1:1	1-2/4-5/7-8	75	1.8	3.0	8	0.20	0.30	T2	SMT4	2000	
PE-65727	5, 6c	1:1	1-2/4-5/7-8	150	1.2	3.0	12	0.20	0.30	T2	SMT4	2000	
PE-65728	5, 6c	1:1	1-2/4-5/7-8	100	1.8	3.0	9	0.20	0.30	T2	SMT4	2000	
PE-68801	5, 6c	1:1	1-2/3-4/5-6	75	1.8	3.0	12	0.20	0.30	T8	SMT3	2000	
<b>THROUGH HOLE</b>												pages 6-7	page 10
PE-64102	5, 6a	1:1	1-2/4-5/7-8	75	2.1	3.0	10	0.20	0.20	T2	TH4	500	
PE-64103	5, 6a	1:1	1-2/4-5/7-8	100	2.1	3.0	10	0.20	0.30	T2	TH4	500	
PE-64104	5, 6a	1:1	1-2/4-5/7-8	150	2.1	3.5	12	0.20	0.30	T2	TH4	500	
PE-64107	5, 6a	1:1	1-2/4-5/7-8	75	2.4	3.5	10	0.25	0.30	T2	TH2	2000	
PE-64108	5, 6a	1:1	1-2/4-5/7-8	100	2.1	3.5	10	0.25	0.40	T2	TH2	2000	
PE-64109	5, 6a	1:1	1-2/4-5/7-8	150	3.0	3.0	15	0.20	0.45	T2	TH2	2000	
PE-64502	5, 6a	1:1	1-2/4-5/7-8	75	2.1	3.0	10	0.20	0.20	T2	TH4	2000	
PE-64503	5, 6a	1:1	1-2/4-5/7-8	100	2.1	3.0	10	0.20	0.30	T2	TH4	2000	

### NOTES:

1. OCL, C<sub>ww</sub> and L<sub>L</sub> are measured at 20 mVrms, 100 kHz.
2. Rise time is measured in 75 Ω systems.
3. For Tape & Reel packaging, add a suffix “T” to the end of the part number when ordering. e.g. PE-65723T.
4. Add suffix **NL** for RoHS compliant parts, e.g: 23Z91SM changes to 23Z91SMNL or 23Z91SMNLT (for Tape & Reel).
5. Contact Pulse for RoHS compliant part availability.
6. MSL=Moisture Sensitivity Level a=1 b=2 c=3 d=4 e=5.

## Typical Application Circuit

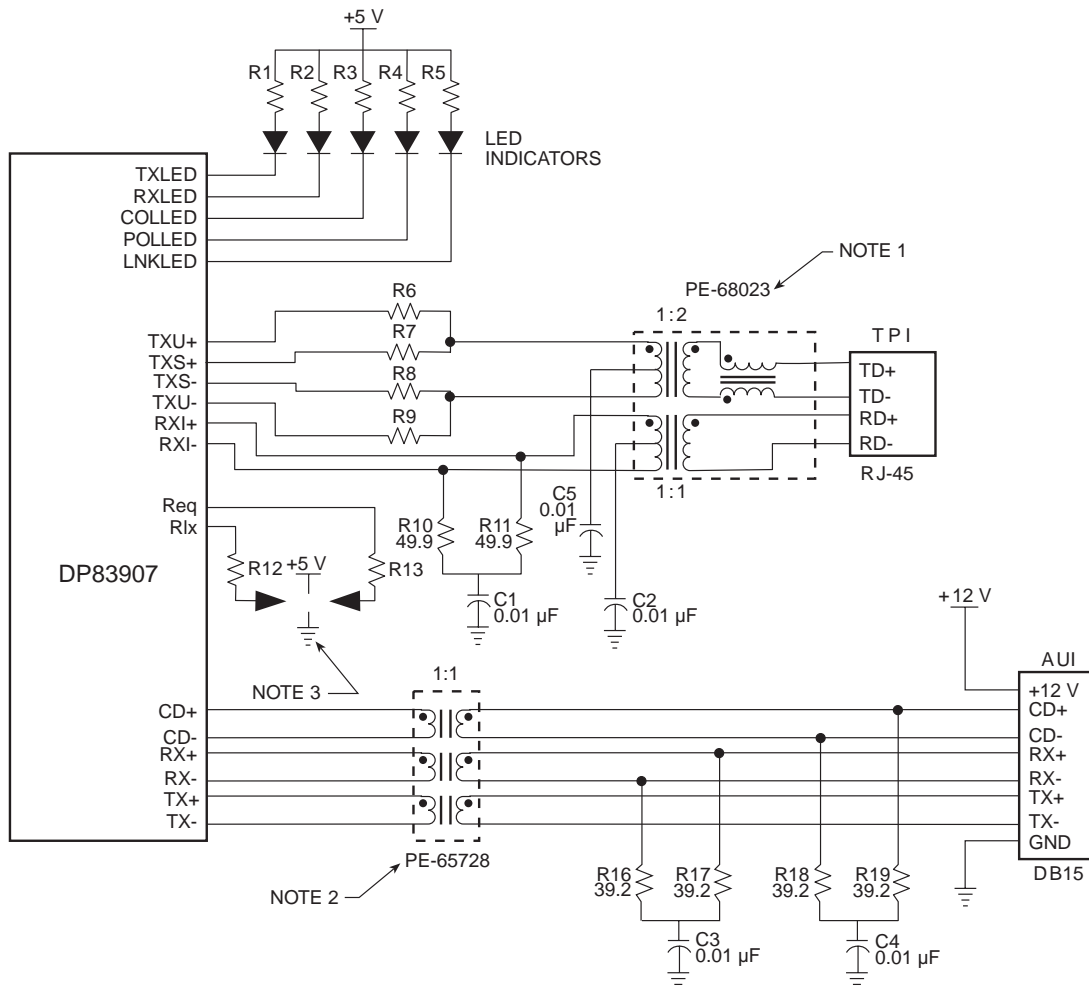

### NOTES:

1. Connections at pins 12 and 13 apply to PE-68023 only. These are test points. **Do not ground.**
2. For specific information, see pages 2 and 3 in this catalog.
3. For specific connection, refer to National's Application Notes.

## Typical 10Base-T Application Circuit

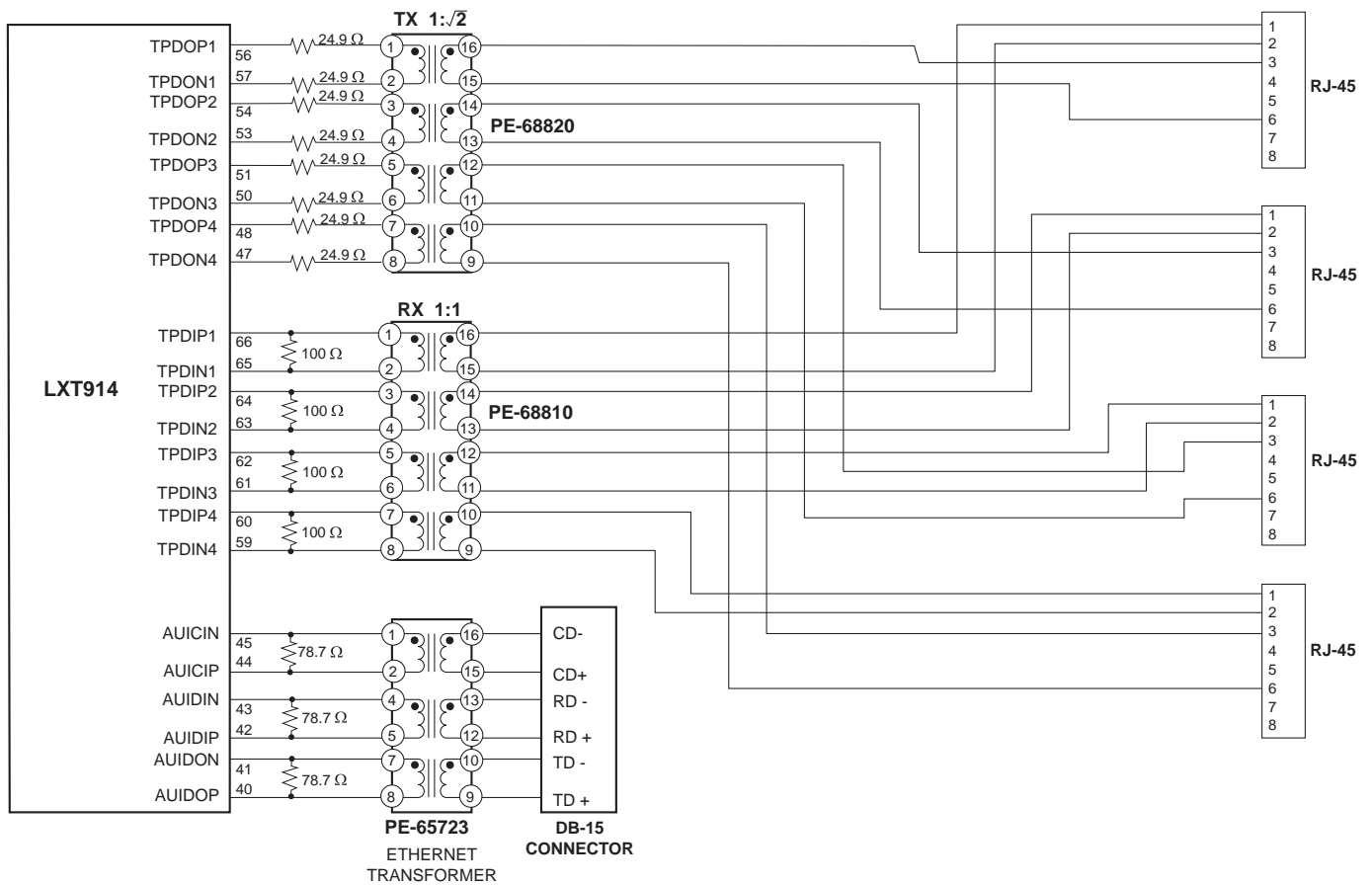

## Schematics

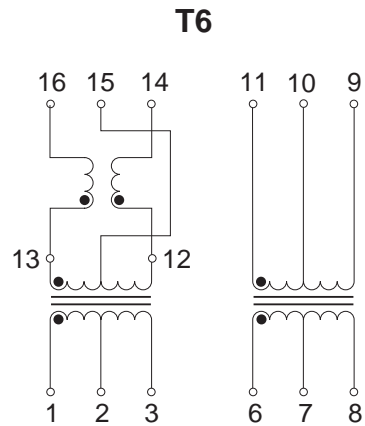
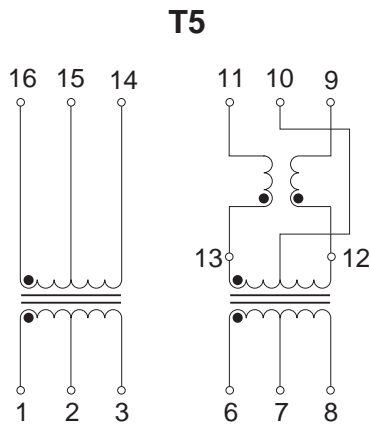
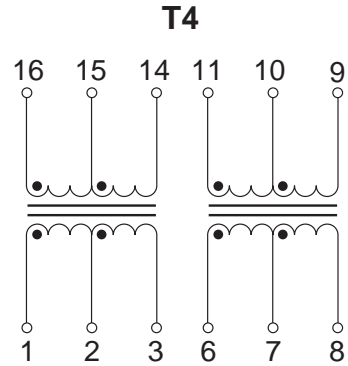
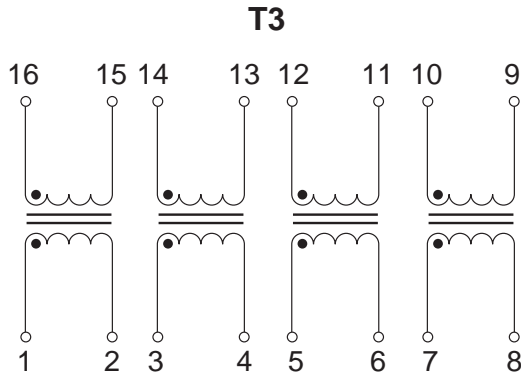
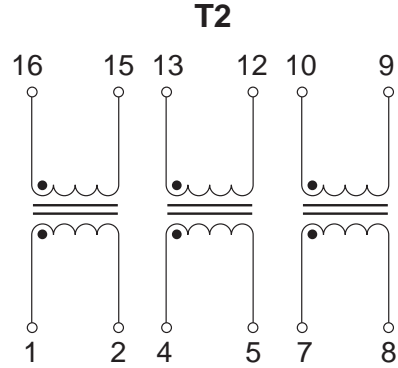
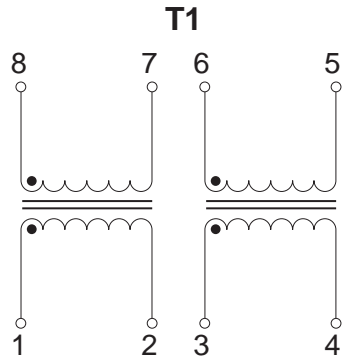

## Schematics (continued)

**T7**

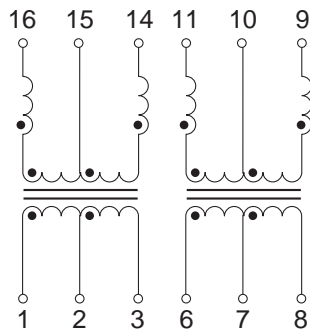

**T8**

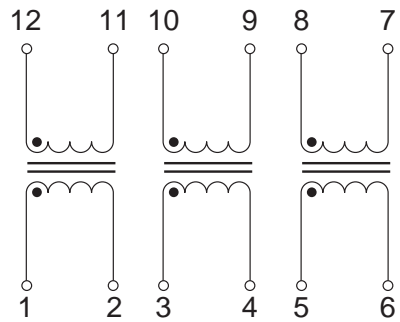

**T9**

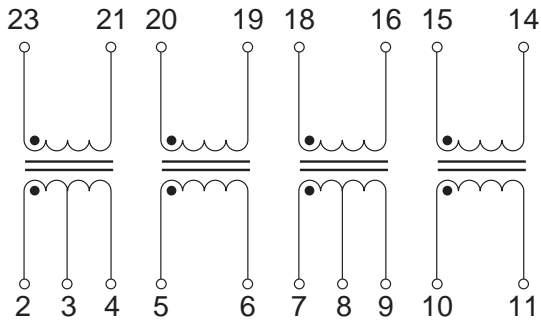

**T10**

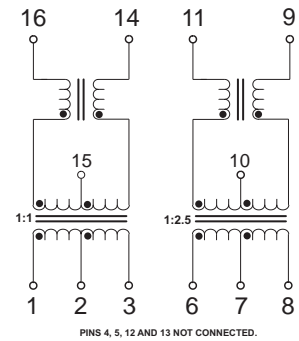

## Surface Mount Mechanicals

### SMT1

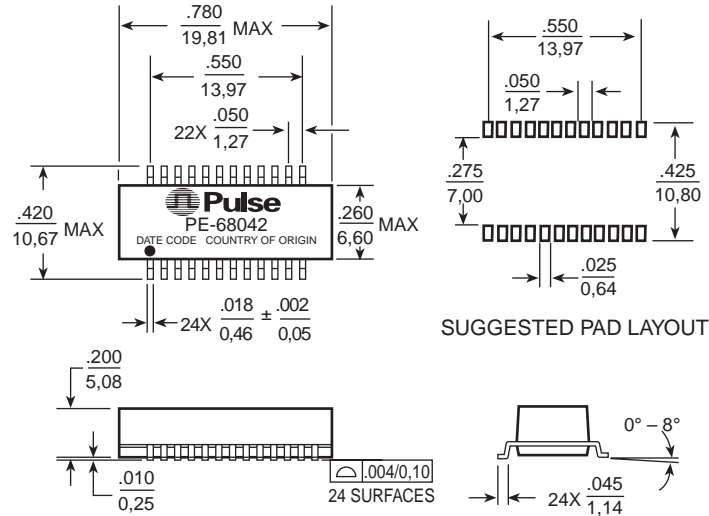

**Dimensions:** Inches  
mm  
Unless otherwise specified,  
all tolerances are ± .010  
0,25

**Weight** .....1.15 grams  
**Tube** ..... .25/tube  
**Tape & Reel** ..... .350/reel

### SMT2

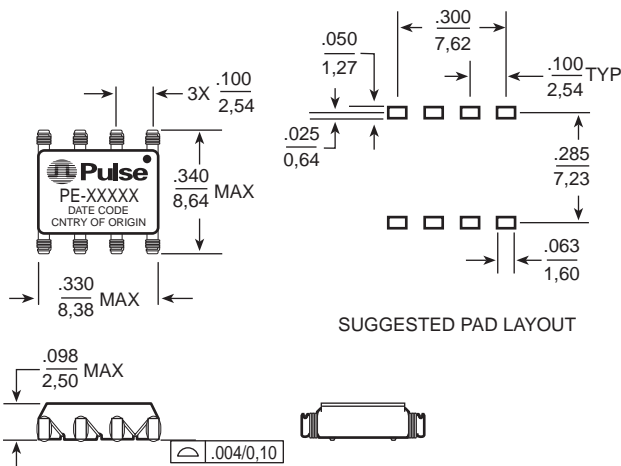

**Weight** .....0.22 grams  
**Tube** ..... .60/tube  
**Tape & Reel** ..... .1500/reel

**Dimensions:** Inches  
mm  
Unless otherwise specified, all tolerances are ± .010  
0,25

### SMT3

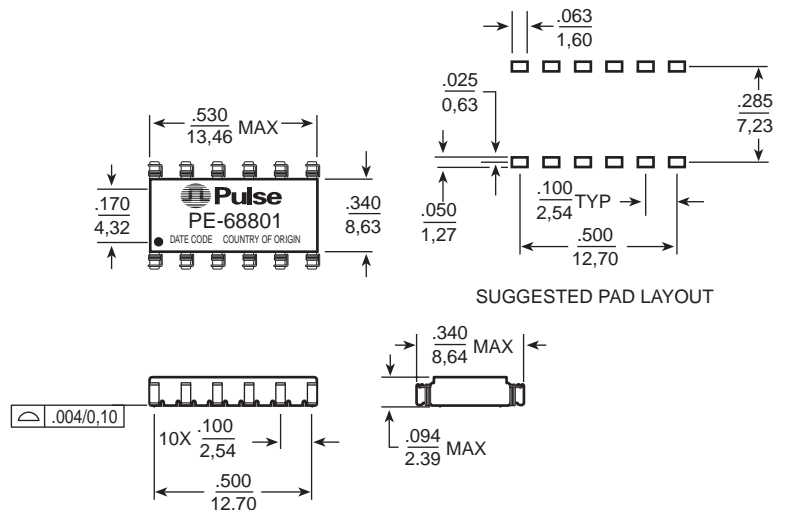

**Weight** .....0.28 grams  
**Tube** ..... .35/tube  
**Tape & Reel** ..... .1500/reel



**Surface Mount Mechanicals** *(continued)*

**SMT4**

\*PE-6XXXX, EXXX, EX2XXX

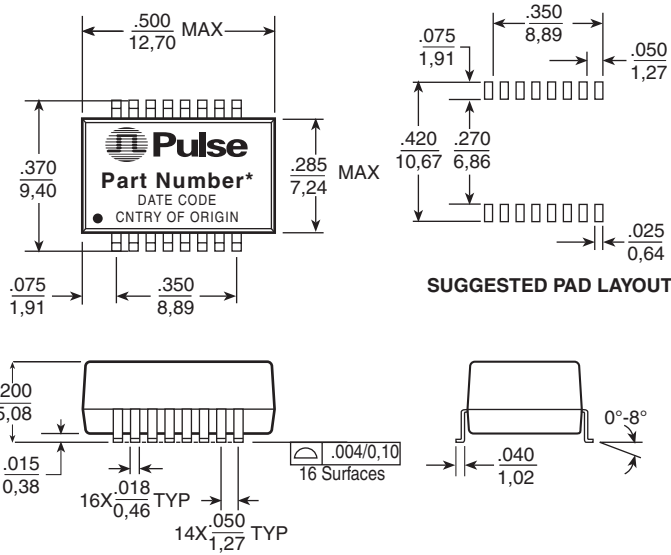

Dimensions:  $\frac{\text{Inches}}{\text{mm}}$

Unless otherwise specified, all tolerances are  $\pm \frac{.010}{0,25}$

Weight ..... 0.82 grams

Tube ..... .40/tube

Tape & Reel ..... .900/reel

**SMT5**

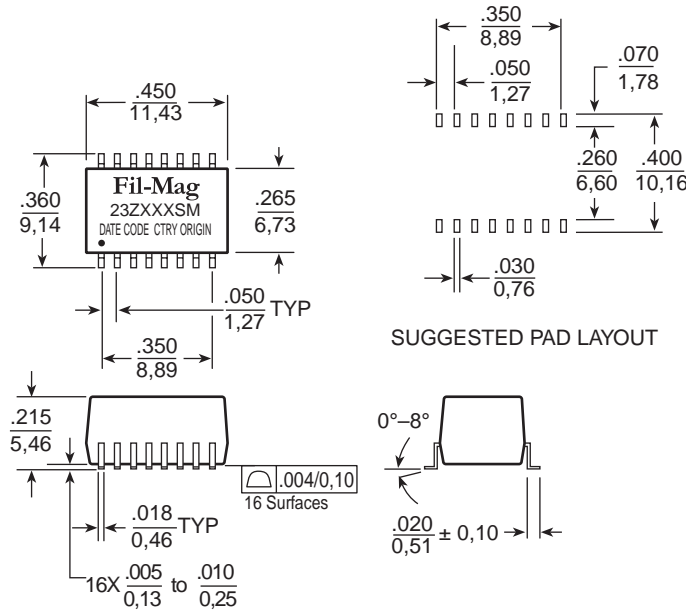

Dimensions:  $\frac{\text{Inches}}{\text{mm}}$

Unless otherwise specified, all tolerances are  $\pm \frac{.005}{0,13}$

Weight ..... 0.85 grams

Tube ..... .50/tube

Tape & Reel ..... .750/reel

## Through Hole Mechanicals

### TH1

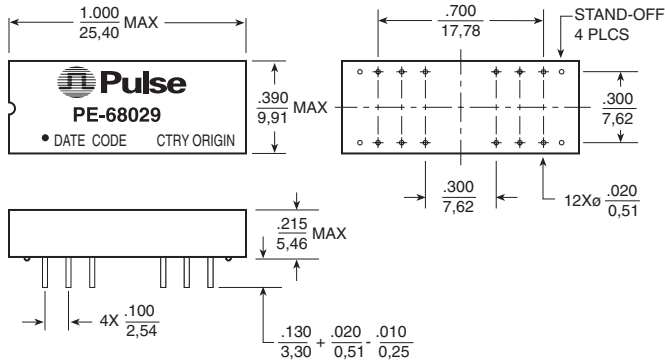

### TH2

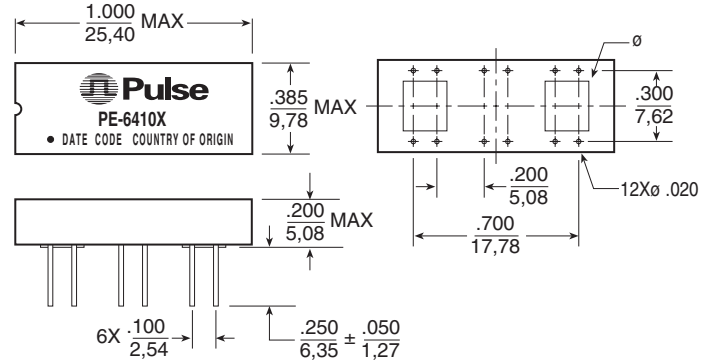

Weight ..... 2.17 grams  
 Tube ..... .20/tube

Dimensions:  $\frac{\text{Inches}}{\text{mm}}$  Unless otherwise specified, all tolerances are  $\pm \frac{.010}{0,25}$

Weight ..... 2.18 grams  
 Tube ..... .20/tube

### TH3

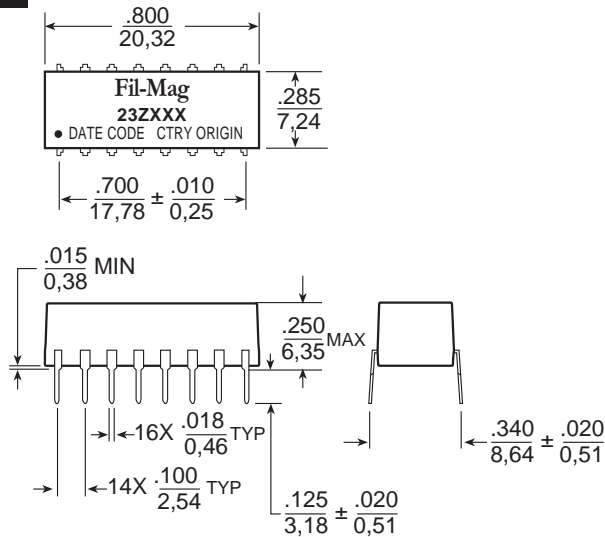

Weight ..... 1.7 grams  
 Tube ..... .28/tube

Dimensions:  $\frac{\text{Inches}}{\text{mm}}$   
 Unless otherwise specified, all tolerances are  $\pm \frac{.005}{0,13}$

### TH4

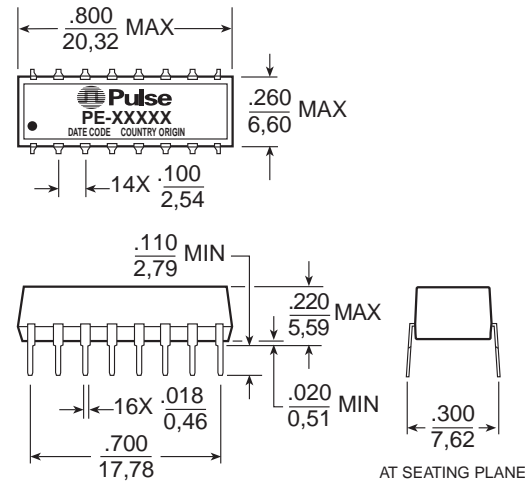

Dimensions:  $\frac{\text{Inches}}{\text{mm}}$   
 Unless otherwise specified, all tolerances are  $\pm \frac{.010}{0,25}$

## For More Information:

UNITED STATES (Worldwide)	UNITED KINGDOM (Northern Europe)	FRANCE (Southern Europe)	SINGAPORE (Southern Asia)	TAIWAN, R.O.C. (Northern Asia)	HONG KONG (China/Hong Kong)	DISTRIBUTOR
12220 World Trade Drive San Diego, CA 92128 U.S.A. http://www.pulseeng.com TEL: 858 674 8100 FAX: 858 674 8262	3 Huxley Road Surrey Research Park Guildford, Surrey GU2 5RE United Kingdom TEL: 44 1483 401700 FAX: 44 1483 401701	Zone Industrielle F-39270 Orgelet France TEL: 33 3 84 35 04 04 FAX: 33 3 84 25 46 41	150 Kampong Ampat #07-01/02 KA Centre Singapore 368324 TEL: 65 6287 8998 FAX: 65 6280 0080	3F-4, No. 81, Sec. 1 HsinTai Wu Road Hsi-Chih, Taipei Hsien Taiwan, R.O.C. Tel: 886 2 2698 0228 FAX: 886 2 2698 0948	Unit 11, 11/F Wah Lai Industrial Centre 10-14 Kwei Tei Street, Fotan, Shatin, Hong Kong TEL: 852 2788 6588 FAX: 852 2776 1055	

Performance warranty of products offered on this data sheet is limited to the parameters specified. Data is subject to change without notice. Other brand and product names mentioned herein may be trademarks or registered trademarks of their respective owners.  
 © Copyright, 2005. Pulse Engineering, Inc. All right reserved.

# Mouser Electronics

Authorized Distributor

Click to View Pricing, Inventory, Delivery & Lifecycle Information:

Pulse:

[PE-64102](#) [PE-65727](#) [PE-65745](#) [PE-65728](#)