



PART NUMBER	DESCRIPTION
CCRT-33S	Commercial Latching SPDT, DC-18GHz, Internal 50Ω Termination
CRT-33S	Elite Latching SPDT, DC-22GHz, Internal 50Ω Termination

The CCRT-33S/CRT-33S is an internally terminated, broadband, SPDT, electromechanical coaxial switch designed to switch a microwave signal from a common input to either of two outputs. The characteristic impedance is 50 Ohms. Internal terminations provide an impedance match for the unselected port. The switches are small with the minimum spacing that is compatible with SMA connectors.



ENVIRONMENTAL AND PHYSICAL CHARACTERISTICS	
Operating Temperature	
Commercial Model, CCRT-33S	-40°C to 65°C
Elite Model, CRT-33S	-55°C to 85°C
Vibration (MIL-STD-202 Method 214, Condition D, non-operating)	10 g's RMS
Shock (MIL-STD-202 Method 213, Condition D, non-operating)	500 g's
Standard Actuator Life	5,000,000 cycles
Actuator Life w/ Additional Features	1,000,000 cycles
Connector Type	SMA
Humidity (Moisture Seal)	Available
Weight	2.65 oz. (75.13g) (max.)

ELECTRICAL CHARACTERISTICS	
Form Factor	SPDT, break before make
Frequency Range	
CCRT-33S	DC–18 GHz
CRT-33S	DC–22 GHz
Characteristic Impedance	50 Ohms
Terminations	50Ω, 2 Watts CW max.
Operate Time	10 ms (max.)
Release Time	10 ms (max.)
Actuation Voltage Available	12 15 24 28 V
Actuation Current, max. @ ambient	420 350 280 200 mA

PERFORMANCE CHARACTERISTICS				
Frequency	DC–6 GHz	6–12 GHz	12–18 GHz	18–22 GHz
Insertion Loss, dB, max.	0.2	0.3	0.4	0.5
Isolation, dB, min.	80	75	70	70
VSWR, max.	1.1:1	1.2:1	1.3:1	1.5:1

**PART NUMBERING SYSTEM**

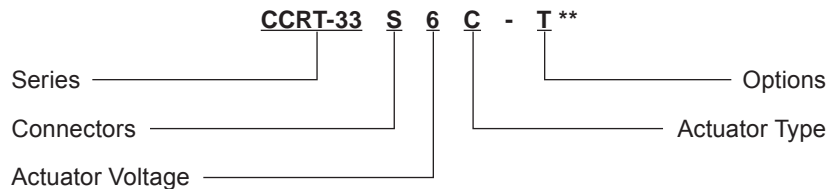

**Connector**  
S: SMA Female

**Actuator Voltage**  
6: 28 Vdc Latching  
7: 15 Vdc Latching  
8: 12 Vdc Latching  
9: 24 Vdc Latching

**Actuator Type**  
0: Standard Contacts  
C: Indicator Contacts  
D: Self Cutoff Only  
E: Indicators and Self Cutoff

**Options**  
T: TTL Drivers with Diodes  
D: Transient Suppression Diodes  
R: Positive + Common  
M: Moisture Seal  
S: 9 Pin D-Sub Connector

\*\*SEE PARTS LIST ON PAGE 8

**For other options, contact factory.**

**Series CCRT-33S/CRT-33S**  
 Internal 50Ω Termination DC-18 GHz/DC-22 GHz  
 Latching SPDT Coaxial Switch



**SCHEMATICS AND MECHANICAL OUTLINE**

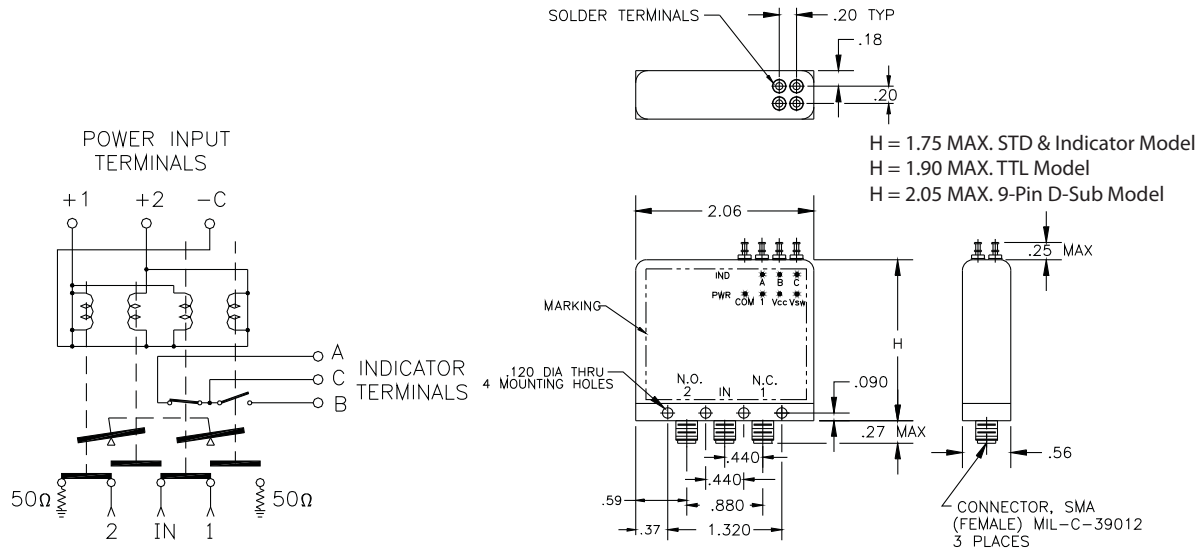

**Indicators**

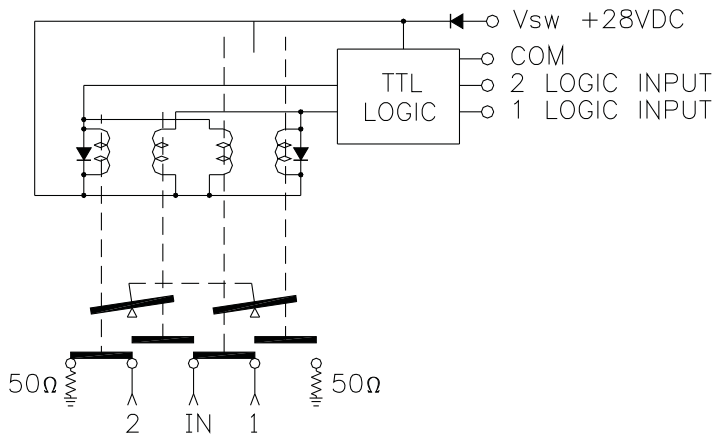

**TTL**

**POWER INPUT TERMINALS**

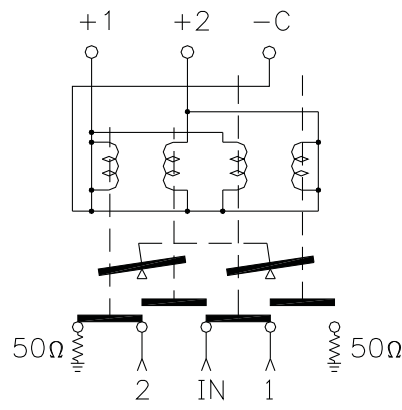

**Analog**

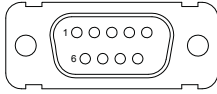

“-S OPTION” 9-PIN D-SUB CONNECTOR (EXAMPLE: CCRT-33S60-S)

9 PIN D-SUB PINOUT FOR LATCHING SPDT				
Pin No.	OPTIONS			
	Basic	Indicators	TTL	Indicators & TTL
1	1	1		
2	2	2		
3	C	C	Common	Common
4			1	1
5			2	2
6			Vsw	Vsw
7		A		A
8		B		B
9		C		C

TRUTH TABLE (with TTL option)					
Logic Input		RF Path		Indicator (if applicable)	
1	2	IN to 1	IN to 2	A	B
0	0	No Change			
1	0	On Terminated		C	0
0	1	Terminated On		0	C
1	1	Forbidden			

**TYPICAL NARROWBAND RF INSERTION LOSS PERFORMANCE CURVES**

Insertion Loss (DC-6 GHz)

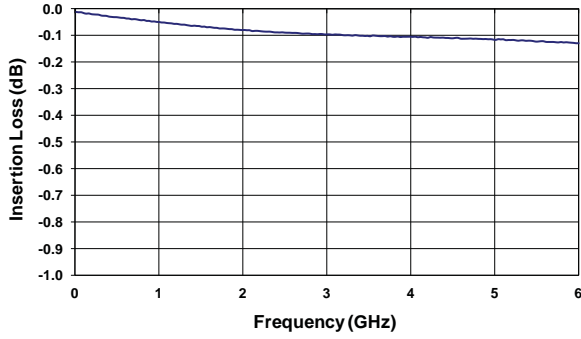

Insertion Loss (6-12 GHz)

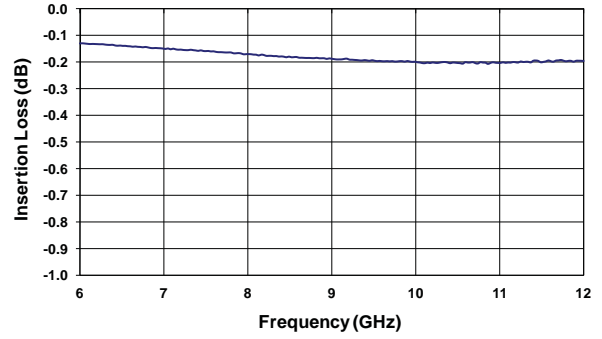

Insertion Loss (12-18 GHz)

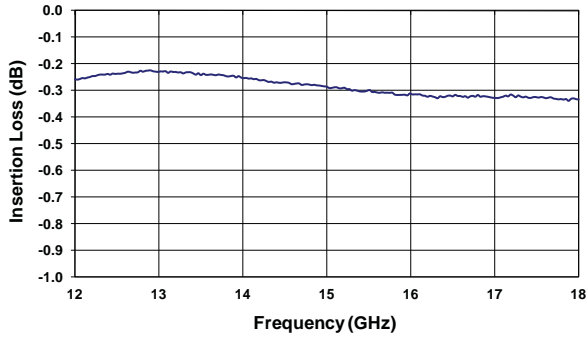

Insertion Loss (18-22 GHz)

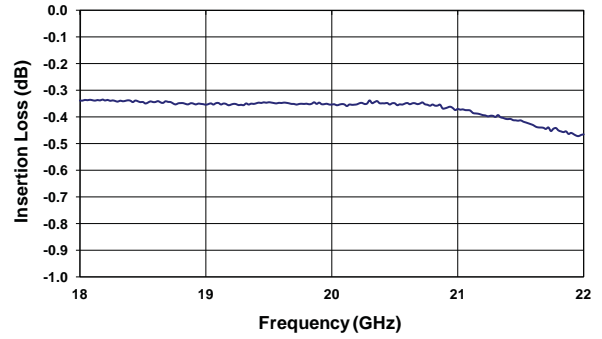

ELITE MODEL ONLY

RF NOTES

**TYPICAL NARROWBAND RF ISOLATION PERFORMANCE CURVES**

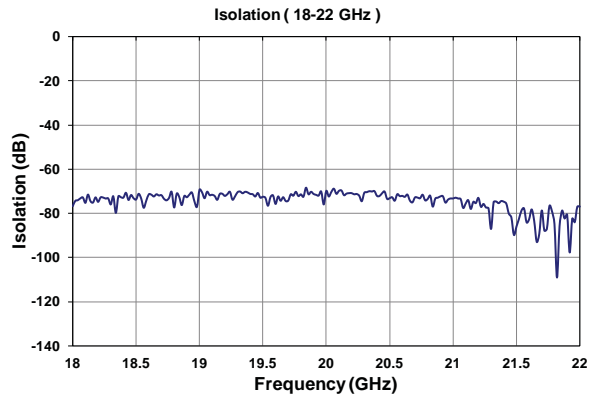
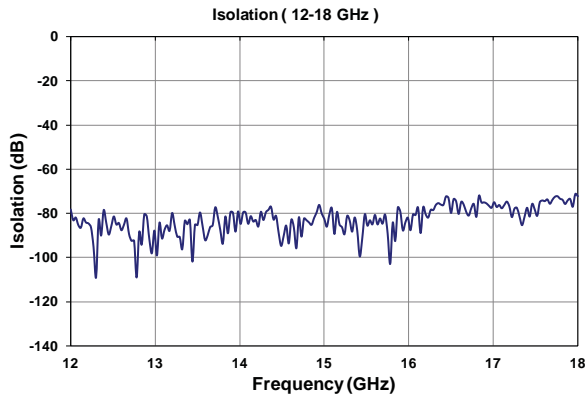
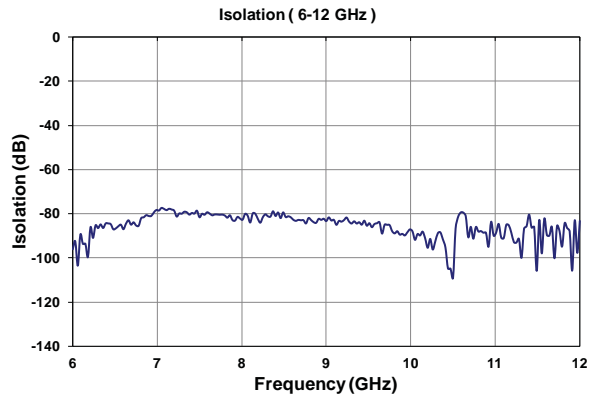
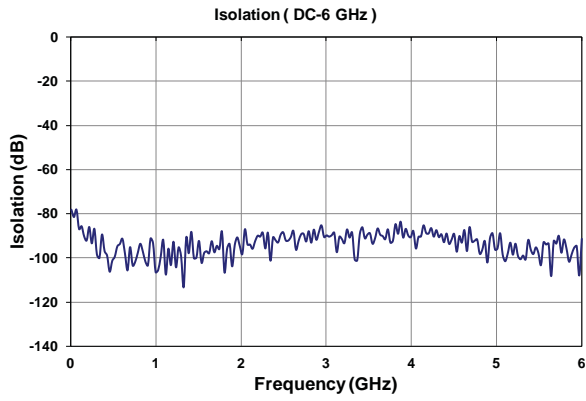

ELITE MODEL ONLY

**RF NOTES**

[Empty box for RF notes]

**TYPICAL NARROWBAND RF VSWR PERFORMANCE CURVES**

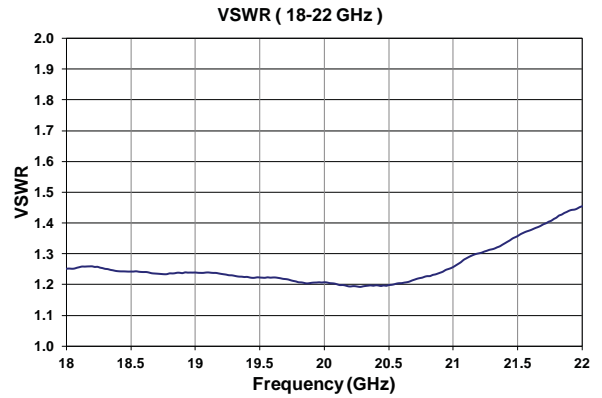
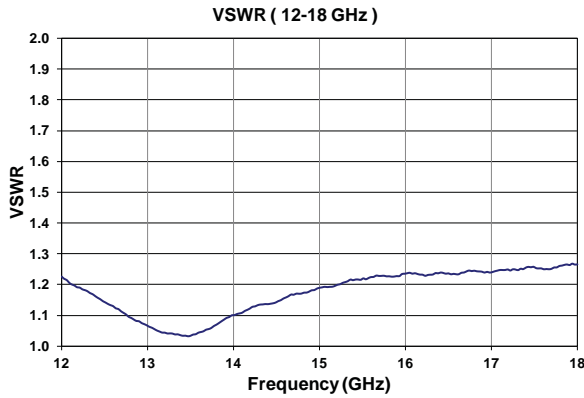
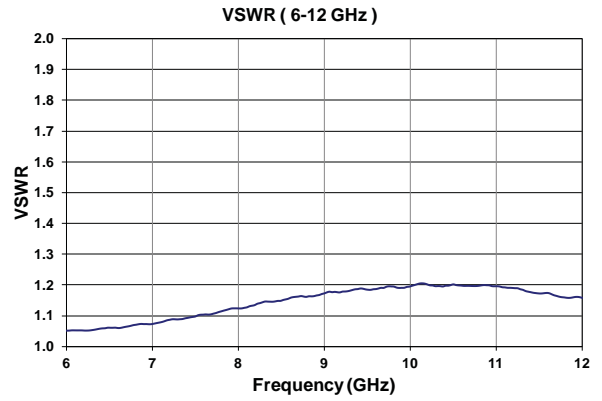
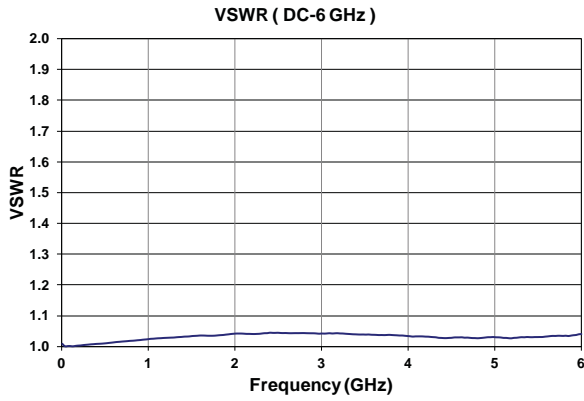

ELITE MODEL ONLY

**RF NOTES**

[Empty box for RF notes]

TYPICAL POWER PERFORMANCE CURVE

# Power Handling vs. Frequency

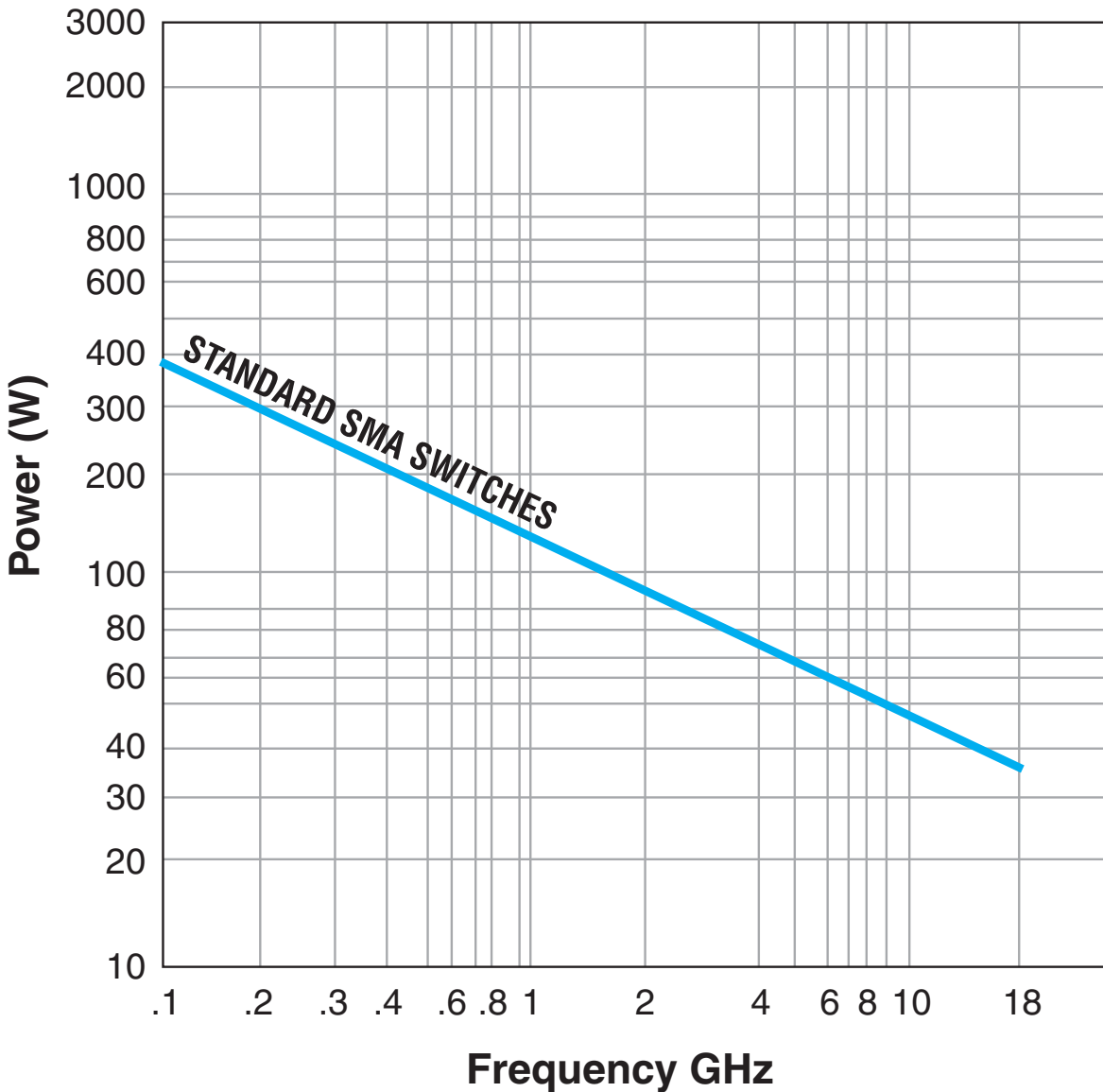

Estimates based on the following reference conditions:

- Ambient temperature of 40°C or less
- Sea level operation
- Load VSWR of 1.20:1 maximum
- No high-power (hot) switching

Please contact Teledyne Coax Switches for derating factors when applications do not meet the foregoing reference conditions.

**GLOSSARY**

**Actuator**

An actuator is the electromechanical mechanism that transfers the RF contacts from one position to another upon DC command.

**Arc Suppression Diode**

A diode is connected in parallel with the coil. This diode limits the “reverse EMF spike” generated when the coil de-energizes to 0.7 volts. The diode cathode is connected to the positive side of the coil and the anode is connected to the negative side.

**Date Code**

All switches are marked with either a unique serial number or a date code. Date codes are in accordance with MIL-STD-1285 Paragraph 5.2.5 and consist of four digits. The first two digits define the year and the last two digits define the week of the year (YYWW). Thus, 1032 identifies switches that passed through final inspection during the 32nd week of 2010.

**Latching**

A latching switch remains in the selected position whether or not voltage is maintained. This can be accomplished with either a magnetic or mechanical latching mechanism.

**Indicator**

Indicators tell the system which position the switch is in. Other names for indicators are telemetry contacts or tellback circuit. Indicators are usually a set of internally mounted DC contacts linked to the actuator. They can be wired to digital input lines, status lights, or interlocks. Unless otherwise specified, the maximum indicator contact rating is 30 Vdc, 50 mA, or 1.5 Watts into a resistive load.

**Internal Termination**

Unselected ports are internally terminated to a matched load. The load is 50Ω resistive device. The max RF power rating is 2 Watts CW. Without the internal termination option, the unselected ports are open circuits.

**Isolation**

Isolation is the measure of the power level at the output connector of an unconnected RF channel as referenced to the power at the input connector. It is specified in dB below the input power level.

**Self-Cutoff**

The self-cutoff option disables the actuator current on completion of actuation. Either a series contact (linked to the actuator) or an IC driver circuit provides the current cutoff. This option results in minimum power consumption by the RF switch. Cutthroat is another name used in the industry for this option. Pulse latching is a term used to describe a switch without this feature.

**SPDT Switch**

A single-pole double-throw, bi-directional switch that can be used as having one input and two outputs or two inputs and one output.

**Switching Time**

Switching time is the total interval beginning with the arrival of the leading edge of the command pulse at the switch DC input

and ending with the completion of the switch transfer, including contact bounce. It consists of three parts: (1) inductive delay in the coil, (2) transfer time of the physical movement of the contacts, and (3) the bounce time of the RF contacts.

**TTL Switch Driver Option**

As a special option, switch drivers can be provided for both failsafe and latching switches, which are compatible with industry-standard low-power Schottky TTL circuits.

**Performance Parameters vs Frequency**

Generally speaking, the RF performance of coaxial switches is frequency dependent. With increasing frequency, VSWR and insertion loss increase while isolation decreases. All data sheets specify these three parameters as “worst case” at the highest operating frequency. If the switch is to be used over a narrow frequency band, better performance can be achieved.

**Actuator Current vs Temperature**

The resistance of the actuator coil varies as a function of temperature. There is an inverse relationship between the operating temperature of the switch and the actuator drive current. For switches operating at 28 VDC, the approximate actuator drive current at temperature, T, can be calculated using the equation:

$$I_T = \frac{I_A}{[1 + .00385 (T-20)]}$$

Where:

$I_T$  = Actuator current at temperature, T

$I_A$  = Room temperature actuator current – see data sheet

T = Temperature of interest in °C

**Magnetic Sensitivity**

An electro-mechanical switch can be sensitive to ferrous materials and external magnetic fields. Neighboring ferrous materials should be permitted no closer than 0.5 inches and adjacent external magnetic fields should be limited to a flux density of less than 5 Gauss.

**SPECIAL FEATURE**

**Switching High-Power or Highly Sensitive Signals**

Ensure the most linear response with the best galvanically matched contact system in the industry. Extremely low passive intermodulation is standard on all of our switches.

Carrier Frequency 1	Carrier Frequency 2	PIM 3rd Order Frequency	PIM 5th Order Frequency
870 MHz	893 MHz	847 MHz	824 MHz

	3rd Order Intermodulation	5th Order Intermodulation
SPDT	–91 dBm	–110 dBm
	–134 dBc	–153 dBc

**Series CCRT-33S/CRT-33S**  
 Internal 50Ω Termination DC–18 GHz/DC-22 GHz  
 Latching SPDT Coaxial Switch



**LATCHING CCRT-33S/CRT-33S PART NUMBER LIST**

	PART No.		PART No.
1	CCRT-33SXC	43	CRT-33SX0-MS
2	CCRT-33SXC-D	44	CRT-33SX0-S
3	CCRT-33SXC-DM	45	CRT-33SX0-T
4	CCRT-33SXC-DMS	46	CRT-33SX0-TM
5	CCRT-33SXC-DS	47	CRT-33SX0-TMS
6	CCRT-33SXC-M	48	CRT-33SX0-TS
7	CCRT-33SXC-MS		
8	CCRT-33SXC-S		
9	CCRT-33SXC-T		
10	CCRT-33SXC-TM		
11	CCRT-33SXC-TMS		
12	CCRT-33SXC-TS		
13	CCRT-33SX0		
14	CCRT-33SX0-D		
15	CCRT-33SX0-DM		
16	CCRT-33SX0-DMS		
17	CCRT-33SX0-DS		
18	CCRT-33SX0-M		
19	CCRT-33SX0-MS		
20	CCRT-33SX0-S		
21	CCRT-33SX0-T		
22	CCRT-33SX0-TM		
23	CCRT-33SX0-TMS		
24	CCRT-33SX0-TS		
25	CRT-33SXC		
26	CRT-33SXC-D		
27	CRT-33SXC-DM		
28	CRT-33SXC-DMS		
29	CRT-33SXC-DS		
30	CRT-33SXC-M		
31	CRT-33SXC-MS		
32	CRT-33SXC-S		
33	CRT-33SXC-T		
34	CRT-33SXC-TM		
35	CRT-33SXC-TMS		
36	CRT-33SXC-TS		
37	CRT-33SX0		
38	CRT-33SX0-D		
39	CRT-33SX0-DM		
40	CRT-33SX0-DMS		
41	CRT-33SX0-DS		
42	CRT-33SX0-M		

\* X = 6 (28Vdc), 7 (15Vdc), 8 (12Vdc) and 9 (24Vdc)