

GENERAL FEATURES

- $V_{DS} = -30V$ $I_D = -8A$
- $R_{DS(ON)} < -22m\Omega$ @ $V_{GS}=10V$
- $R_{DS(ON)} < -26m\Omega$ @ $V_{GS}=4.5V$

Application

- Load/Power Switching
- Interfacing Switching
- Logic Level Shift

Package and Pin Configuration

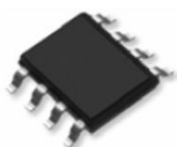

SOP-8 top view

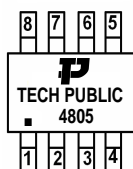
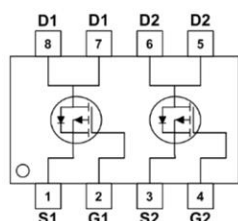

Circuit diagram

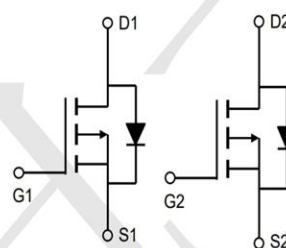

Absolute Maximum Ratings ($T_A=25^\circ C$ unless otherwise noted)

Symbol	Parameter	Rating	Units
V_{DS}	Drain-Source Voltage	30	V
V_{GS}	Gate-Source Voltage	± 20	V
$I_D@T_A=25^\circ C$	Continuous Drain Current ³	8	A
$I_D@T_A=70^\circ C$	Continuous Drain Current ³	7	A
I_{DM}	Pulsed Drain Current ¹	40	A
$P_D@T_A=25^\circ C$	Total Power Dissipation	2	W
	Linear Derating Factor	0.016	W/ $^\circ C$
T_{STG}	Storage Temperature Range	-55 to 150	$^\circ C$
T_J	Operating Junction Temperature Range	-55 to 150	$^\circ C$

Thermal Data

Symbol	Parameter	Value	Unit
R_{thj-a}	Thermal Resistance Junction-ambient ³	Max. 62.5	$^\circ C/W$

Electrical Characteristics (T_A=25°C unless otherwise noted)

Symbol	Parameter	Test Conditions	Min.	Typ.	Max.	Units
BV _{DSS}	Drain-Source Breakdown Voltage	V _{GS} =0V, I _D =250uA	30	-	-	V
ΔBV _{DSS} /ΔT _j	Breakdown Voltage Temperature Coefficient	Reference to 25°C, I _D =1mA	-	0.01	-	V/°C
R _{DS(ON)}	Static Drain-Source On-Resistance ²	V _{GS} =10V, I _D =8A	-	-	22	mΩ
		V _{GS} =4.5V, I _D =6A	-	-	26	mΩ
V _{GS(th)}	Gate Threshold Voltage	V _{DS} =V _{GS} , I _D =250uA	1	-	3	V
g _{fs}	Forward Transconductance	V _{DS} =10V, I _D =8A	-	8	-	S
I _{DSS}	Drain-Source Leakage Current (T _J =25°C)	V _{DS} =30V, V _{GS} =0V	-	-	1	uA
		V _{DS} =24V, V _{GS} =0V	-	-	25	uA
I _{GSS}	Gate-Source Leakage	V _{GS} =±20V	-	-	±100	nA
Q _g	Total Gate Charge ²	I _D =8A	-	14.5	23	nC
Q _{gs}	Gate-Source Charge	V _{DS} =24V	-	2.3	-	nC
Q _{gd}	Gate-Drain ("Miller") Charge	V _{GS} =4.5V	-	7.7	-	nC
t _{d(on)}	Turn-on Delay Time ²	V _{DS} =15V	-	7.2	-	ns
t _r	Rise Time	I _D =1A	-	8.6	-	ns
t _{d(off)}	Turn-off Delay Time	R _G =3.3Ω, V _{GS} =10V	-	24.8	-	ns
t _f	Fall Time	R _D =15Ω	-	8.6	-	ns
C _{iss}	Input Capacitance	V _{GS} =0V	-	950	1420	pF
C _{oss}	Output Capacitance	V _{DS} =25V	-	220	-	pF
C _{rss}	Reverse Transfer Capacitance	f=1.0MHz	-	160	-	pF
R _g	Gate Resistance	f=1.0MHz	-	1	1.5	Ω

Source-Drain Diode

Symbol	Parameter	Test Conditions	Min.	Typ.	Max.	Units
V _{SD}	Forward On Voltage ²	I _S =1.7A, V _{GS} =0V	-	-	1.2	V
t _{rr}	Reverse Recovery Time ²	I _S =8A, V _{GS} =0V,	-	25	-	ns
Q _{rr}	Reverse Recovery Charge	di/dt=100A/μs	-	21	-	nC

Typical Electrical and Thermal Characteristics

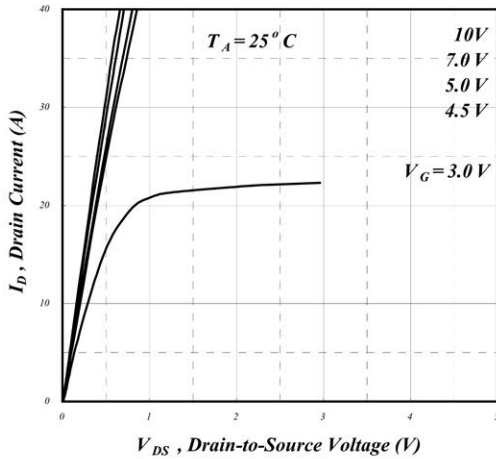

Fig 1. Typical Output Characteristics

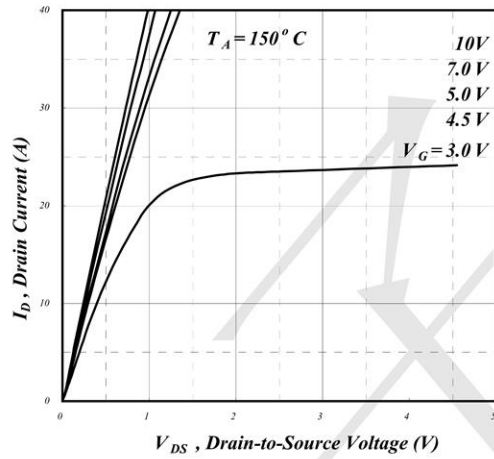

Fig 2. Typical Output Characteristics

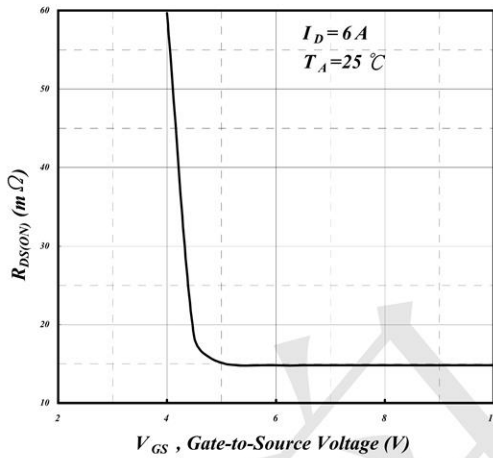

Fig 3. On-Resistance v.s. Gate Voltage

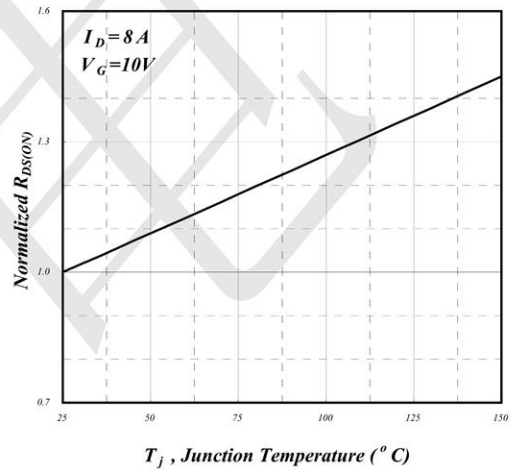

Fig 4. Normalized On-Resistance v.s. Junction Temperature

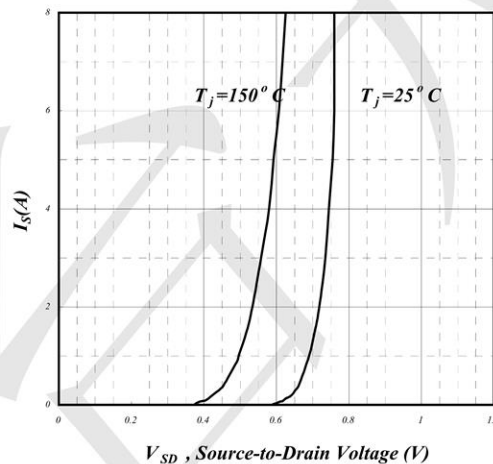

Fig 5. Forward Characteristic of Reverse Diode

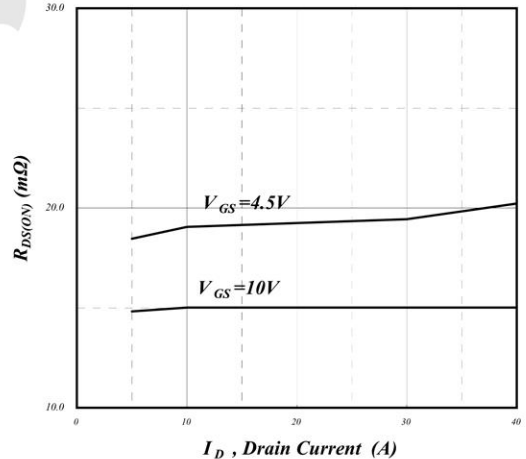

Fig 6. On-Resistance vs. Drain Current

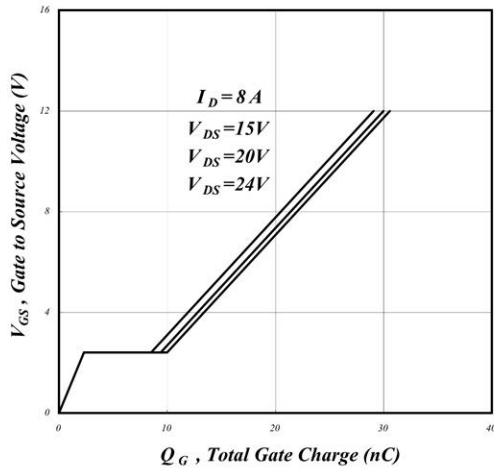

Fig 7. Gate Charge Characteristics

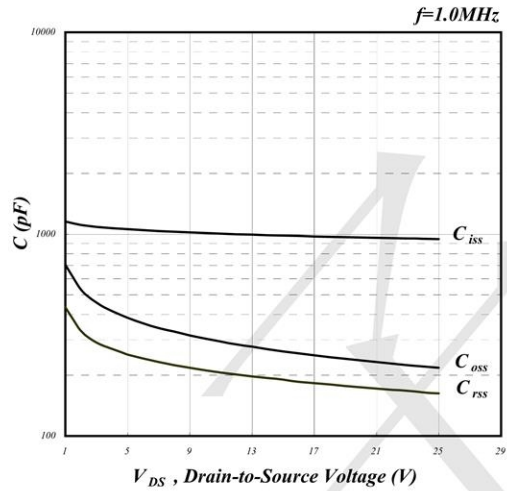

Fig 8. Typical Capacitance Characteristics

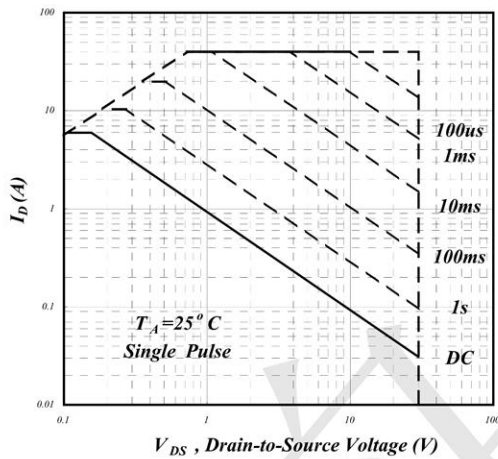

Fig 9. Maximum Safe Operating Area

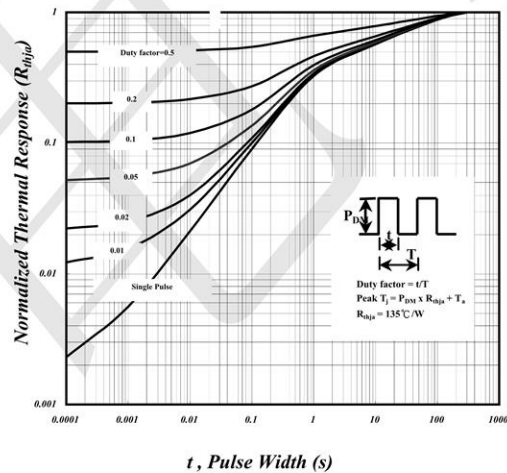

Fig 10. Effective Transient Thermal Impedance

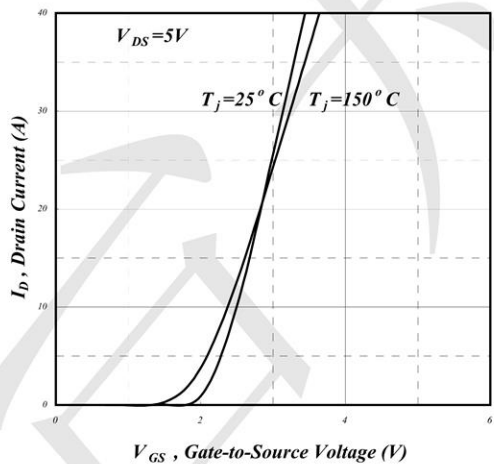

Fig 11. Transfer Characteristics

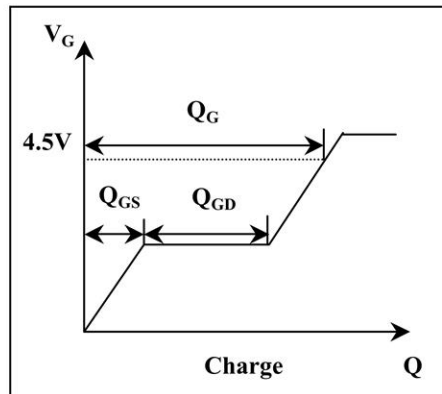
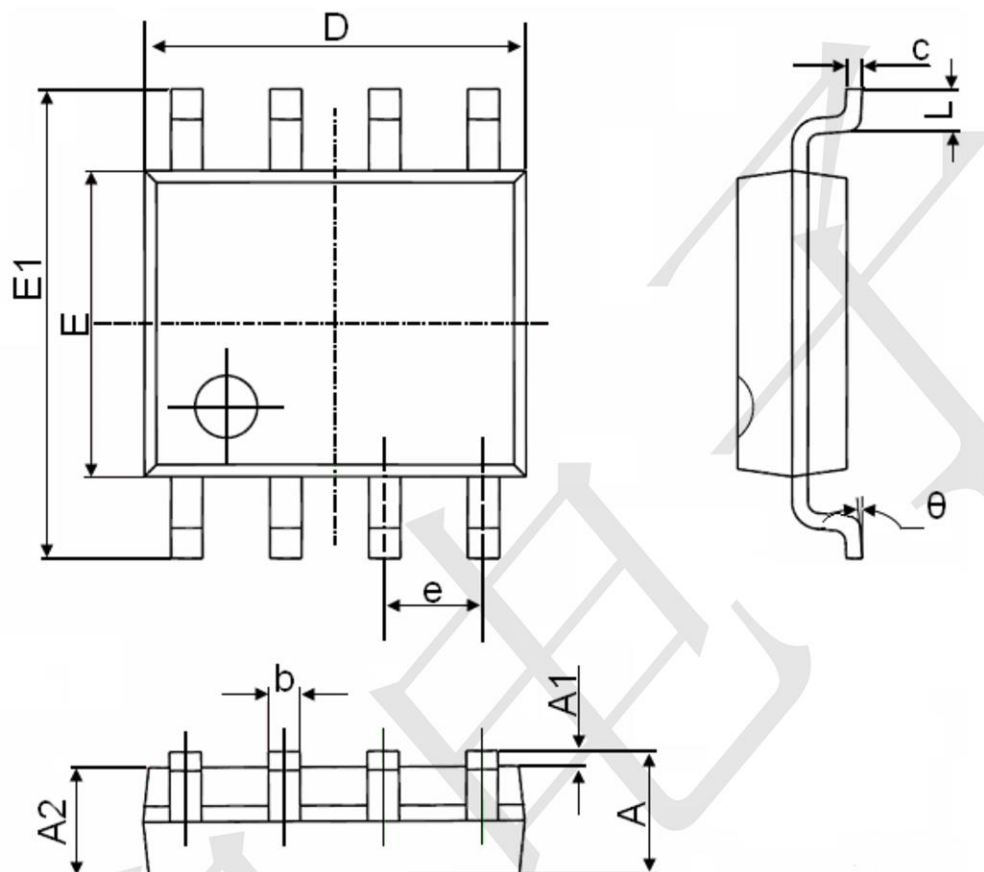

Fig 12. Gate Charge Waveform

SOP-8 Package Information



Symbol	Dimensions In Millimeters		Dimensions In Inches	
	Min.	Max.	Min.	Max.
A	1.350	1.750	0.053	0.069
A1	0.100	0.250	0.004	0.010
A2	1.350	1.550	0.053	0.061
b	0.330	0.510	0.013	0.020
c	0.170	0.250	0.006	0.010
D	4.700	5.100	0.185	0.200
E	3.800	4.000	0.150	0.157
E1	5.800	6.200	0.228	0.244
e	1.270(BSC)		0.050(BSC)	
L	0.400	1.270	0.016	0.050
θ	0°	8°	0°	8°