



2SD2136

NPN SILICON TRANSISTOR

POWER TRANSISTOR

DESCRIPTION

The UTC **2SD2136** is designed for power amplification.

FEATURES

- * High forward current transfer ratio h_{FE} which has satisfactory linearity.
- * Low collector to emitter saturation voltage $V_{CE(SAT)}$.
- * Allowing supply with the radial taping.

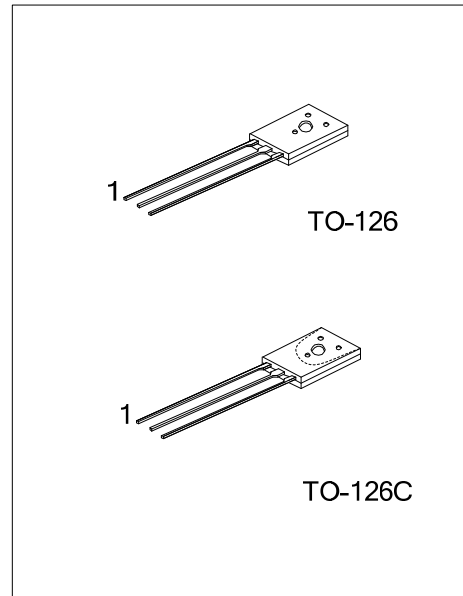

ORDERING INFORMATION

Ordering Number		Package	Pin Assignment			Packing
Lead Free	Halogen Free		1	2	3	
2SD2136L-x-T60-K	2SD2136G-x-T60-K	TO-126	B	C	E	Bulk
2SD2136L-x-T6C-K	2SD2136G-x-T6C-K	TO-126C	B	C	E	Bulk

<p>2SD2136L-x-T60-K</p>	<p>(1) Packing Type (2) Package Type (3) Rank (4) Lead Free</p> <p>(1) K: Bulk (2) T60: TO-126, T6C: TO-126C (3) x: Refer to Classification of h_{FE1} (4) G: Halogen Free, L: Lead Free</p>
-------------------------	---

■ ABSOLUTE MAXIMUM RATINGS (Ta=25°C, unless otherwise specified)

PARAMETER	SYMBOL	RATINGS	UNIT
Collector-Base Voltage	V_{CBO}	60	V
Collector-Emitter Voltage	V_{CEO}	60	V
Emitter-Base Voltage	V_{EBO}	6	V
Collector Current	I_C	3	A
Peak Collector Current	I_{CP}	5	A
Collector Dissipation	P_C	1.5	W
Junction Temperature	T_J	150	°C
Storage Temperature	T_{STG}	-55 ~ +150	°C

Note: Absolute maximum ratings are those values beyond which the device could be permanently damaged.

Absolute maximum ratings are stress ratings only and functional device operation is not implied.

■ ELECTRICAL CHARACTERISTICS (Ta=25°C, unless otherwise specified)

PARAMETER	SYMBOL	TEST CONDITIONS	MIN	TYP	MAX	UNIT
Collector-Base Breakdown Voltage	BV_{CEO}	$I_C=30mA, I_B=0$	60			V
Collect Cutoff Current	I_{CEO}	$V_{CE}=60V, I_B=0$			300	μA
Collect Cutoff Current	I_{CES}	$V_{CE}=60V, V_{BE}=0$			200	μA
Emitter Cutoff Current	I_{EBO}	$V_{BE}=6V, I_C=0$			1	mA
DC Current Gain	h_{FE1}	$V_{CE}=4V, I_C=1A$	40		250	
	h_{FE2}	$V_{CE}=4V, I_C=3A$	10			
Collector-Emitter Saturation Voltage	$V_{CE(SAT)}$	$I_C=3A, I_B=0.375A$			1.2	V
Base-Emitter Voltage	V_{BE}	$V_{CE}=4V, I_C=3A$			1.8	V
Current Gain Bandwidth Product	f_T	$V_{CE}=15V, I_E=0.1A, f=200MHz$		220		MHz
Turn On Time	t_{ON}	$I_C=1A, I_{B1}=0.1A, I_{B2}=0.1A$		0.5		μS
Storage Time	t_S			2.5		μS
Fall Time	t_F			0.4		μS

■ CLASSIFICATION OF h_{FE1}

RANK	P	Q	R
RANGE	40-90	70-150	120-250

TYPICAL CHARACTERISTICS

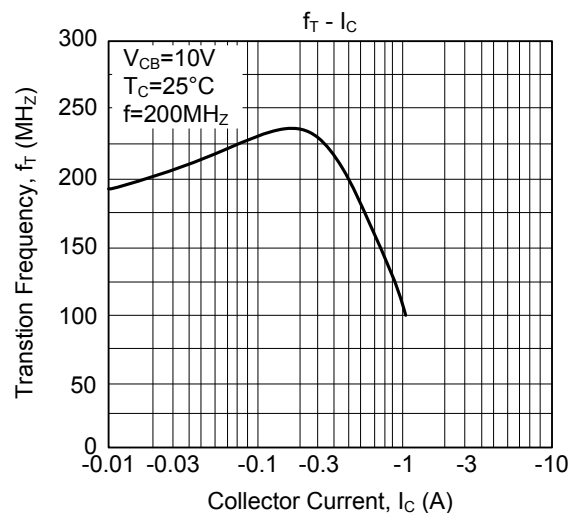
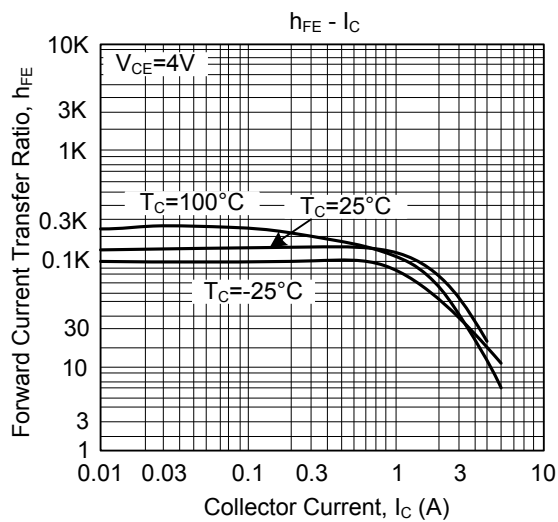
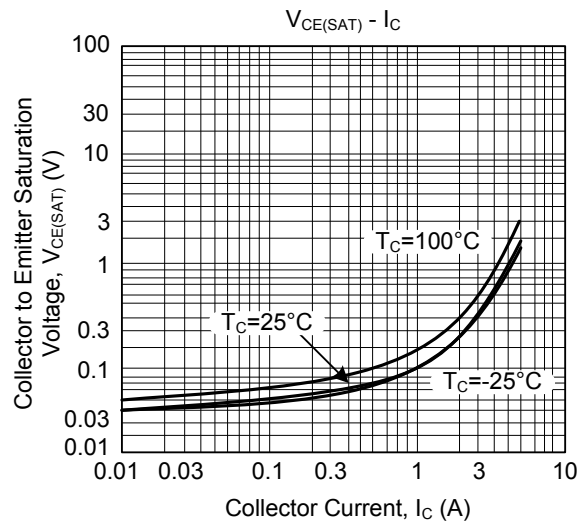
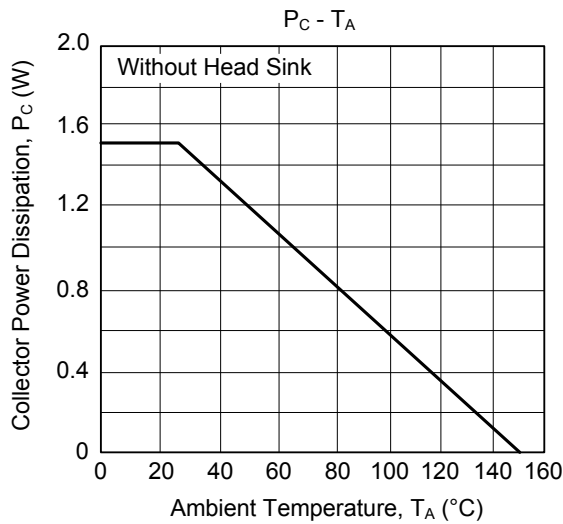
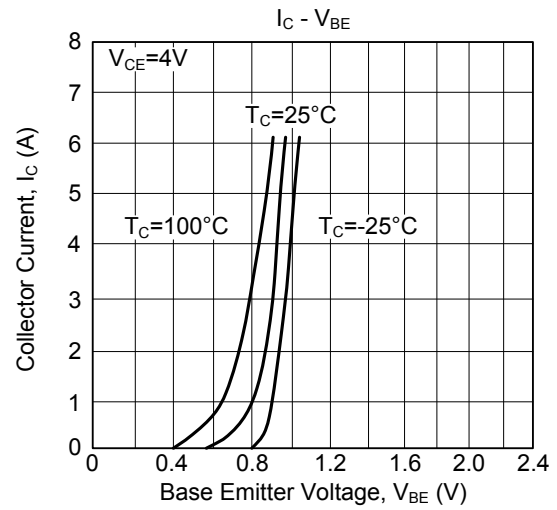
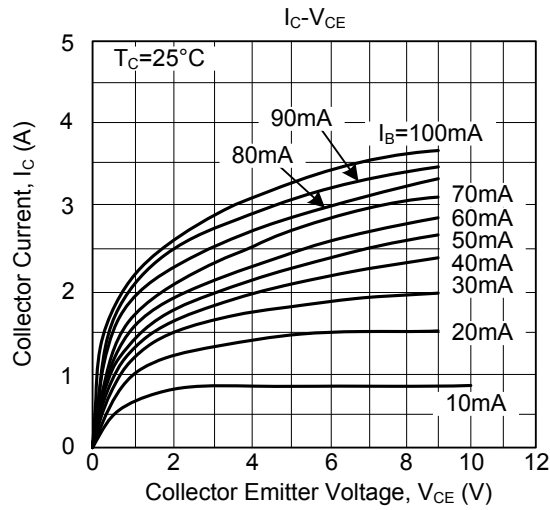

■ TYPICAL CHARACTERISTICS(Cont.)

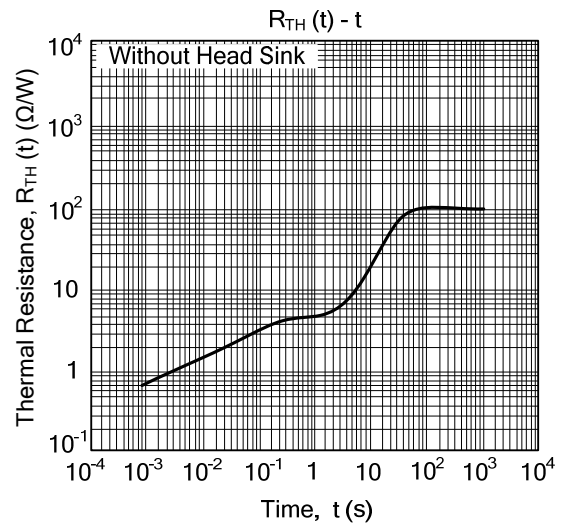
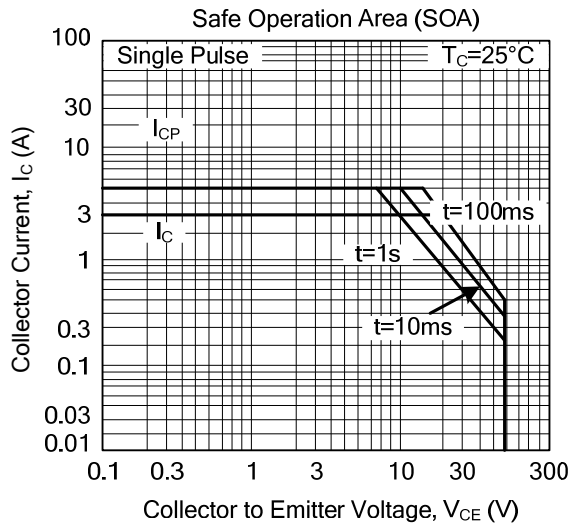

UTC assumes no responsibility for equipment failures that result from using products at values that exceed, even momentarily, rated values (such as maximum ratings, operating condition ranges, or other parameters) listed in products specifications of any and all UTC products described or contained herein. UTC products are not designed for use in life support appliances, devices or systems where malfunction of these products can be reasonably expected to result in personal injury. Reproduction in whole or in part is prohibited without the prior written consent of the copyright owner. The information presented in this document does not form part of any quotation or contract, is believed to be accurate and reliable and may be changed without notice.