

1. PART NO. EXPRESSION :

PDC3015N-1R6YF
 (a) (b) (c) (d) (e)(f)

(a) Series code
 (b) Dimension code
 (c) Type code

(d) Inductance code : 1R6 = 1.6uH
 (e) Tolerance code : M = ±20%, Y = ±30%
 (f) F : Lead Free

2. CONFIGURATION & DIMENSIONS :

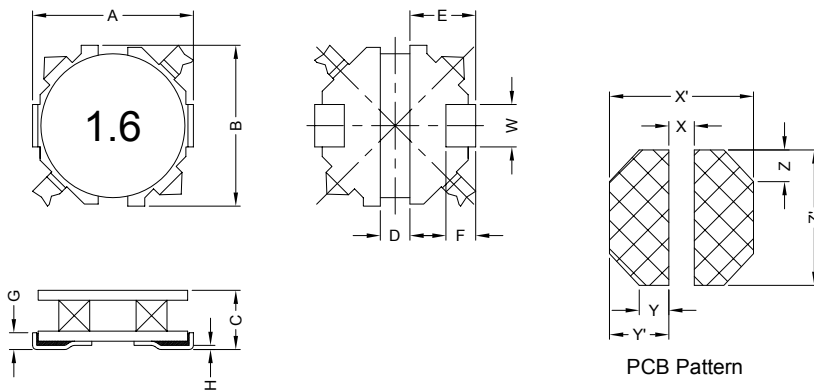

A	B	C	D	E	F	G	H
3.00±0.2	3.00±0.2	1.5 Max.	0.80 Max.	1.10 Max.	0.40 Typ.	0.30 Typ.	0.10 Typ.
W	X'	X	Y'	Y	Z'	Z	
1.0 Typ.	3.40±0.1	0.60±0.1	1.40±0.1	0.70±0.1	3.20±0.1	0.75±0.1	

3. SCHEMATIC :

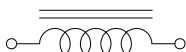

4. MATERIALS :

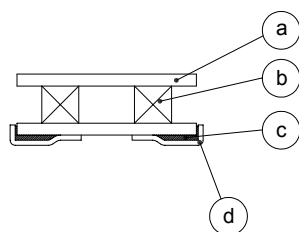

(a) Core : Ferrite Core
 (b) Wire : Enamelled Copper Wire
 (c) Adhesive : Epoxy
 (d) Clip : Tin Clip



RoHS Compliant

NOTE : Specifications subject to change without notice. Please check our website for latest information.

18.04.2008

5. GENERAL SPECIFICATION :

- a) Test Frequency : 100KHz/0.3Vdc
- b) Ambient Temp. : 25°C
- c) Idc(A) : Will cause Lo to drop by 30% and coil temp. rise $\Delta T \leq 45^\circ\text{C}$
- d) Operating temp. : -40°C to +105°C (include self-temp. rise)
- e) Storage temp. : -40°C to +85°C

6. ELECTRICAL CHARACTERISTICS :

Part No.	Inductance (μH)	Test Frequency (Hz)	DCR (Ω) $\pm 20\%$	IDC (A) Max.
PDC3015N-1R6YF	1.6 $\pm 30\%$	0.3V/100K	0.065	1.50
PDC3015N-2R2YF	2.2 $\pm 30\%$	0.3V/100K	0.082	1.30
PDC3015N-3R3YF	3.3 $\pm 30\%$	0.3V/100K	0.110	1.00
PDC3015N-4R7YF	4.7 $\pm 30\%$	0.3V/100K	0.160	0.86
PDC3015N-6R8YF	6.8 $\pm 30\%$	0.3V/100K	0.220	0.80
PDC3015N-100MF	10 $\pm 20\%$	0.3V/100K	0.280	0.70
PDC3015N-220MF	22 $\pm 20\%$	0.3V/100K	0.800	0.46

7. CHARACTERISTICS CURVES :

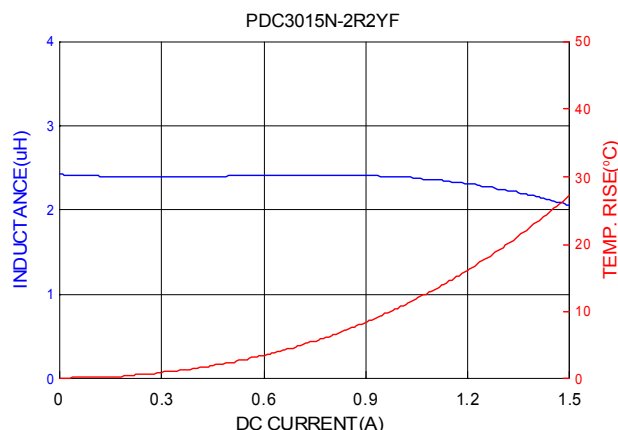
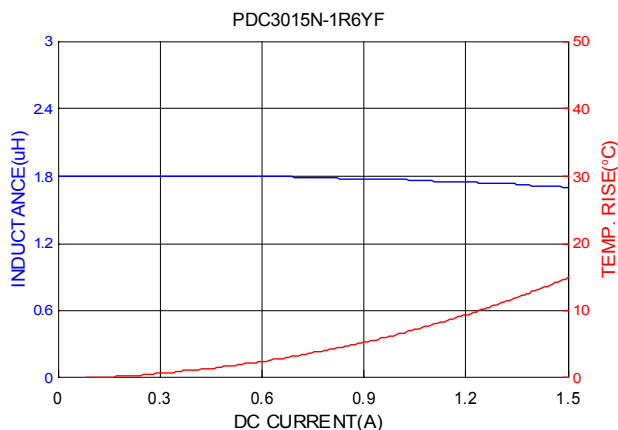

RoHS Compliant

NOTE : Specifications subject to change without notice. Please check our website for latest information.

18.04.2008



SUPERWORLD ELECTRONICS (S) PTE LTD

7. CHARACTERISTICS CURVES :

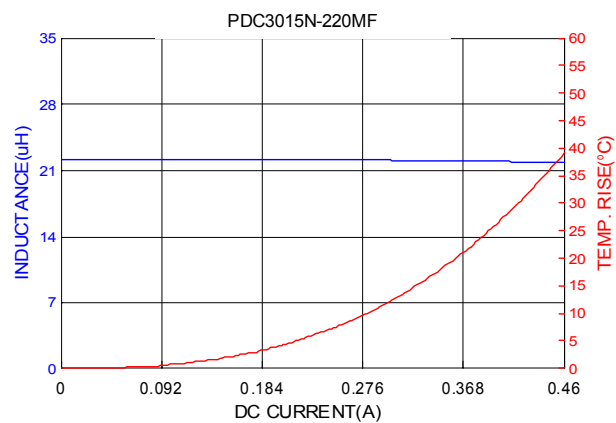
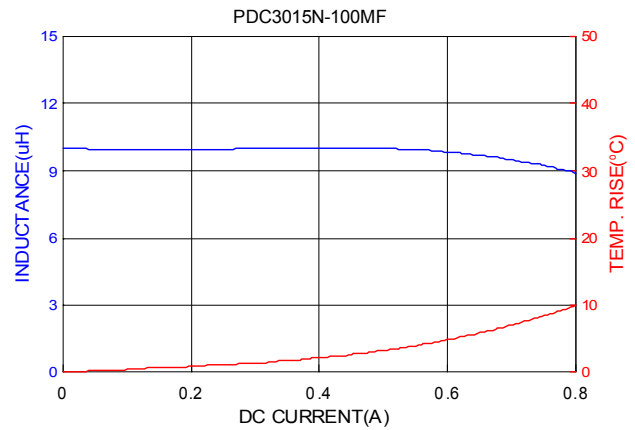
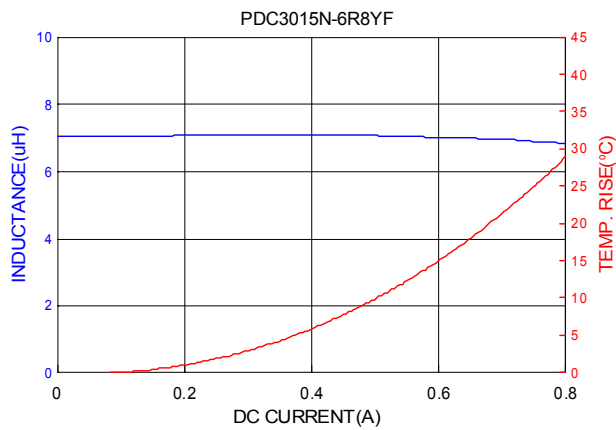
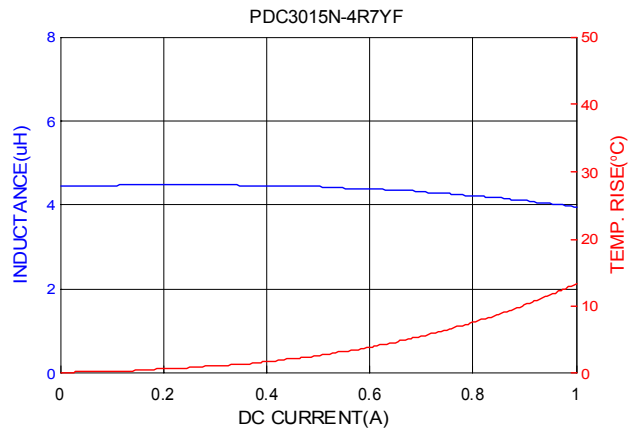
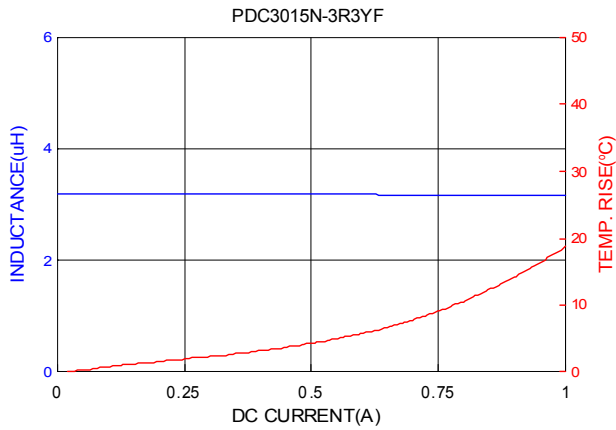

RoHS Compliant

NOTE : Specifications subject to change without notice. Please check our website for latest information.

18.04.2008



SUPERWORLD ELECTRONICS (S) PTE LTD

8. ELECTRICAL CHARACTERISTICS :

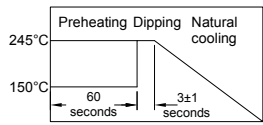
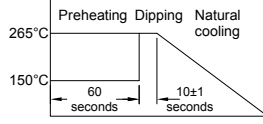
ITEM	PERFORMANCE	TEST CONDITION															
Mechanical Performance Test																	
Solderability Test	More than 90% of the terminal electrode should be covered with solder.	Preheat : 150°C, 60sec. Solder : DD930C Solder Temperature : 245±5°C Flux for lead free : rosin Dip Time : 3±1sec. 															
Solder Heat Resistance	1. Appearance : No significant abnormality 2. Inductance change : Within ±10%	Preheat : 150°C, 60sec. Solder : DD930C Solder Temperature : 265±5°C Dip Time : 10±1sec. 															
Reliability Test																	
Thermal Shock	1. Appearance : No damage 2. Inductance change : Within ±10% of initial value Measured : 50 times	Conditions of 1 cycle. <table border="1" data-bbox="917 929 1284 1064"> <thead> <tr> <th>Step</th> <th>Temperature (°C)</th> <th>Times (min.)</th> </tr> </thead> <tbody> <tr> <td>1</td> <td>-40±2</td> <td>30±3</td> </tr> <tr> <td>2</td> <td>Room temp.</td> <td>15</td> </tr> <tr> <td>3</td> <td>+105±2</td> <td>30±3</td> </tr> <tr> <td>4</td> <td>Room temp.</td> <td>15</td> </tr> </tbody> </table> Total : 50 cycles	Step	Temperature (°C)	Times (min.)	1	-40±2	30±3	2	Room temp.	15	3	+105±2	30±3	4	Room temp.	15
Step	Temperature (°C)	Times (min.)															
1	-40±2	30±3															
2	Room temp.	15															
3	+105±2	30±3															
4	Room temp.	15															
Humidity Resistance	1. Appearance : No damage 2. Inductance change : Within ±10% of initial value	Temperature : 40±2°C Humidity : 90% to 95% Applied Current : Rated Current Time : 500 hours															
High Temperature Resistance Test	1. Appearance : No damage 2. Inductance change : Within ±15% of initial value	Temperature : 105±2°C Time : 500 hrs Applied Current : Rated Current															

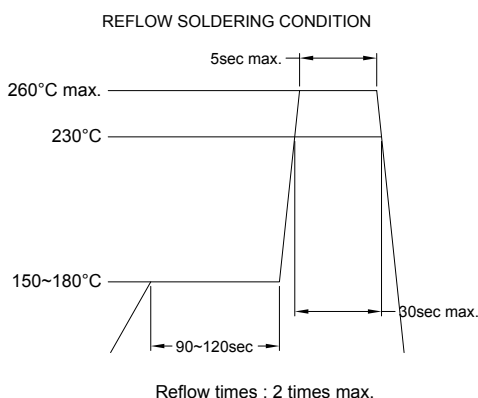

RoHS Compliant

NOTE : Specifications subject to change without notice. Please check our website for latest information.

18.04.2008

9. PACKAGING INFORMATION :

9-1. Reel Dimension

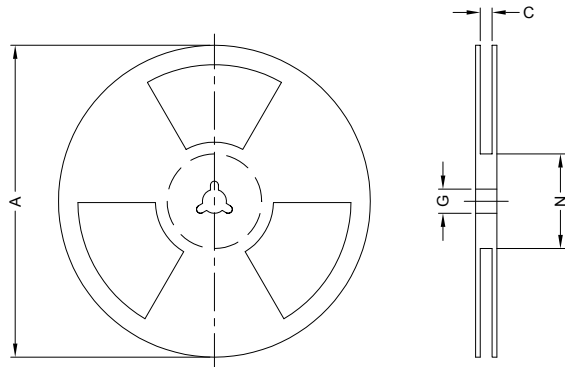

Type	A(mm)	C(mm)	G(mm)	N(mm)
13" x 12mm	330	12.5±0.5	13.0±0.5	100±1.0

9-2 Tape Dimension / 12mm

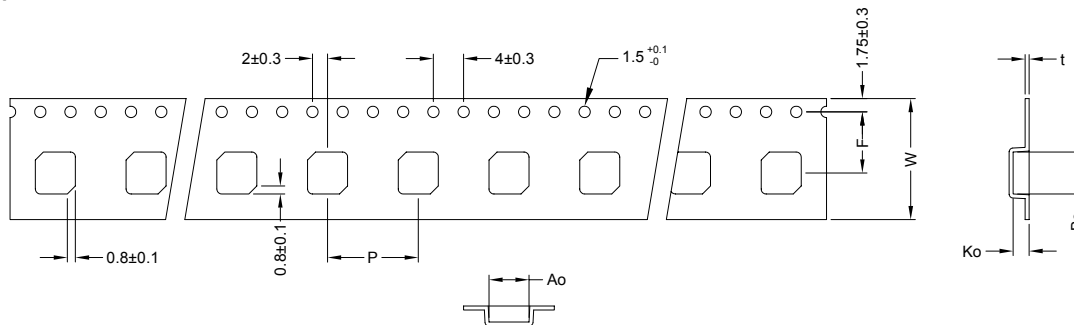

Series	Ao(mm)	Bo(mm)	Ko(mm)	P(mm)	W(mm)	F(mm)	t(mm)
PDC3015N	3.5±0.1	3.5±0.1	1.7±0.1	8.0±0.3	12±0.3	5.5±0.3	0.4±0.1

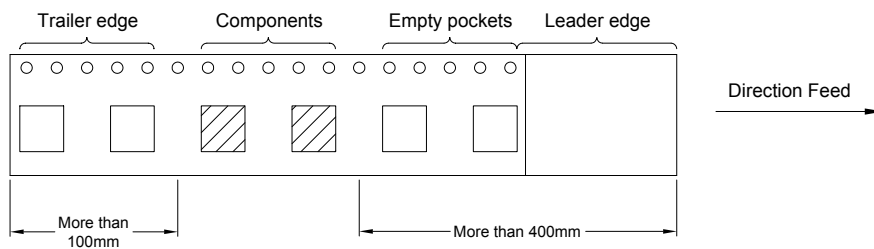

9-3. Packaging Quantity

Size	PDC3015N
Chip / Reel	3000
Inner Box	12000
Carton	48000



RoHS Compliant

NOTE : Specifications subject to change without notice. Please check our website for latest information.

18.04.2008

9-4. Tearing Off Force

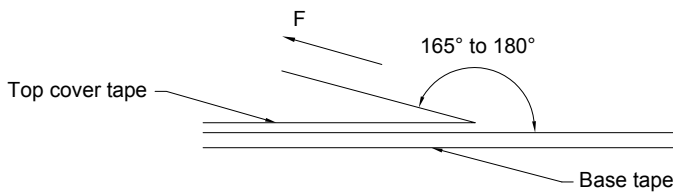

The force for tearing off cover tape is 10 to 125 grams in the arrow direction under the following conditions.

Room Temp. (°C)	Room Humidity (%)	Room atm (hPa)	Tearing Speed (mm/min)
5~35	45~85	860~1060	300

Application Notice

1. Storage Conditions :

To maintain the solderability of terminal electrodes :

- a) Temperature and humidity conditions : Less than 40°C and 70% RH.
- b) Recommended products should be used within 6 months from the time of delivery.
- c) The packaging material should be kept where no chlorine or sulfur exists in the air.

2. Transportation :

- a) Products should be handled with care to avoid damage or contamination from perspiration and skin oils.
- b) The use of tweezers or vacuum pick up is strongly recommended for individual components.
- c) Bulk handling should ensure that abrasion and mechanical shock are minimized.



RoHS Compliant

NOTE : Specifications subject to change without notice. Please check our website for latest information.

18.04.2008



SUPERWORLD ELECTRONICS (S) PTE LTD