

## 600 WATT MULTI-LINE ULTRA LOW CAPACITANCE TVS ARRAY

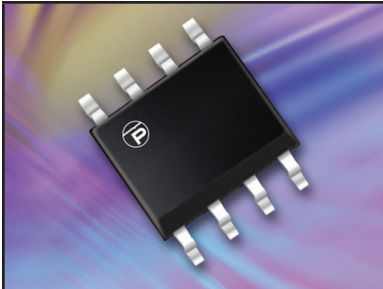

**SO-8 PACKAGE**

### DESCRIPTION

The SLVU2.8-8 is an ultra low capacitance TVS array that provides four line pairs of protection. This device protects high-frequency applications such as voice, video and data related systems and is designed to minimize the effects of high overshoot voltage experienced during and ESD event. This device has an in-line design, which reduces lead inductance thus providing lower overshoot voltage.

The SLVU2.8-8 meets IEC 61000-4-2, IEC 61000-4-4 and IEC 61000-4-5 requirements. Packaged in an SO-8 configuration, this device is rated for 600 Watts Peak Pulse Power, for an 8/20 $\mu$ s waveform.

### FEATURES

- Compatible with IEC 61000-4-2 (ESD): Air - 15kV, Contact - 8kV
- Compatible with IEC 61000-4-4 (EFT): 40A - 5/50ns
- Compatible with IEC 61000-4-5 (Surge): 24A, 8/20 $\mu$ s - Level 2(Line-Gnd) & Level 3(Line-Line)
- 600 Watts Peak Pulse Power per Line (tp = 8/20 $\mu$ s)
- Protects up to Four Line Pairs
- Low Leakage Current < 1.0 $\mu$ A
- Ultra Low Capacitance: 6pF Typical
- RoHS Compliant
- REACH Compliant

### APPLICATIONS

- Ethernet - 10/100/1000 Base T
- SMART Phones
- Audio/Video Inputs
- Portable Electronics

### MECHANICAL CHARACTERISTICS

- Molded JEDEC SO-8 Package
- Approximate Weight: 70 milligrams
- Lead-Free Pure-Tin Plating (Annealed)
- Solder Reflow Temperature:  
Pure-Tin - Sn, 100: 260-270°C
- 12mm Tape and Reel Per EIA Standard 481
- Flammability Rating UL 94V-0

### PIN CONFIGURATION

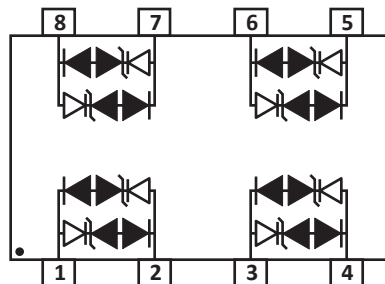

**TYPICAL DEVICE CHARACTERISTICS**
**MAXIMUM RATINGS @ 25°C Unless Otherwise Specified**

PARAMETER	SYMBOL	VALUE	UNITS
Peak Pulse Power (tp = 8/20μs) - See Figure 1	$P_{PP}$	600	Watts
Peak Pulse Current (tp = 8/20μs)	$I_{PP}$	30	Amps
Lead Soldering Temperature	$I_{FRM}$	260	°C
Operating Temperature	$T_L$	-55 to 150	°C
Storage Temperature	$T_{STG}$	-55 to 150	°C

**ELECTRICAL CHARACTERISTICS PER LINE @ 25°C Unless Otherwise Specified**

PART NUMBER (Note 1)	DEVICE MARKING	RATED STAND-OFF VOLTAGE (Note 1)  $V_{WM}$ VOLTS	MINIMUM BREAK-DOWN VOLTAGE (Note 1)  @1mA $V_{(BR)}$ VOLTS	MINIMUM SNAPBACK VOLTAGE (Note 1)  @ $I_{SB} = 50mA$ $V_{SB}$ VOLTS	MAXIMUM CLAMPING VOLTAGE (Note 1) (Fig. 2)				MAXIMUM LEAKAGE CURRENT (Note 1)  @ $V_{WM}$ $I_D$ μA	TYPICAL CAPACITANCE (Note 1)  @0V, 1MHz C pF
					@ $I_{PP} = 2A$ $V_C$ VOLTS	@ $I_{PP} = 5A$ $V_C$ VOLTS	@ $I_{PP} = 24A$ $V_C$ VOLTS	@ $I_{PP} = 30A$ $V_C$ VOLTS		
SLVU2.8-8	SL8	2.8	3.0	2.8	5.5	8.5	15	17	1.0	6

**NOTES**

- Device measured between pin 1 to pin 2, pin 3 to pin 4, pin 5 to pin 6 and pin 7 to pin 8.

## TYPICAL DEVICE CHARACTERISTICS

FIGURE 1  
PEAK PULSE POWER VS PULSE TIME

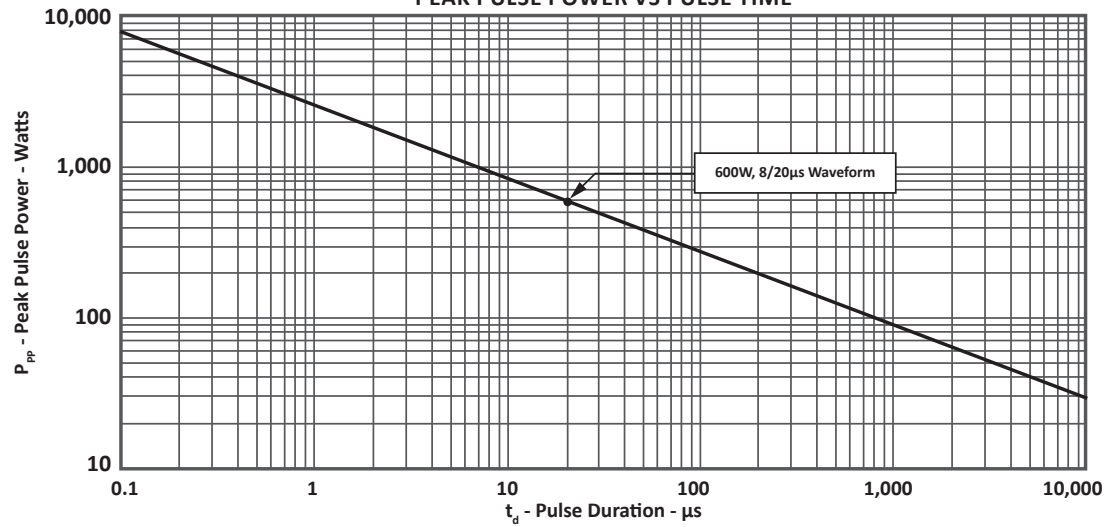
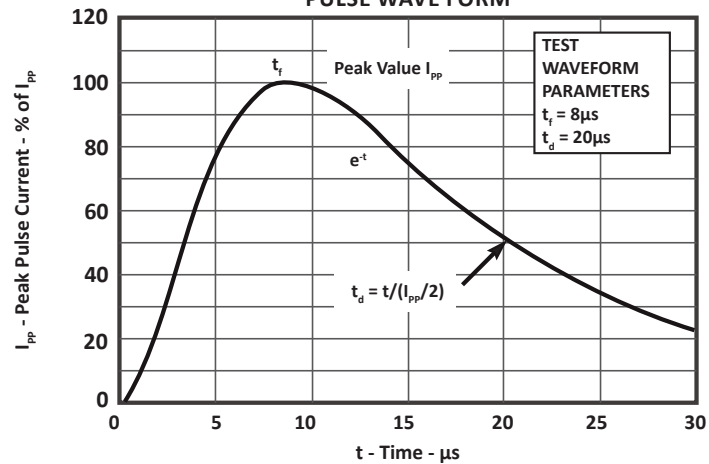
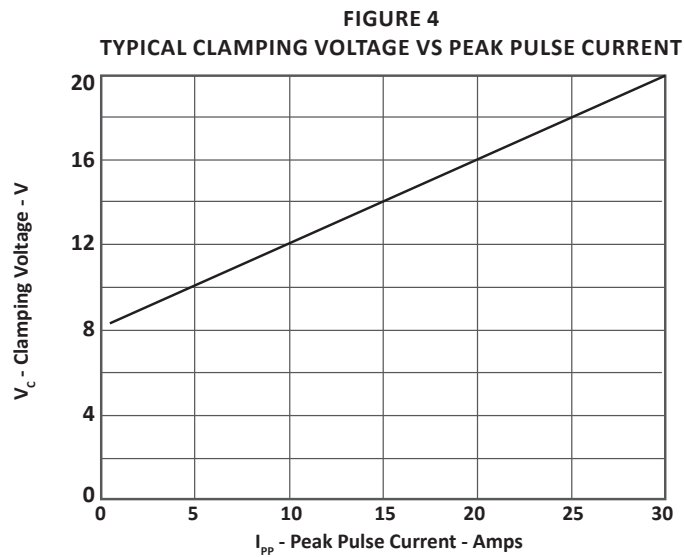
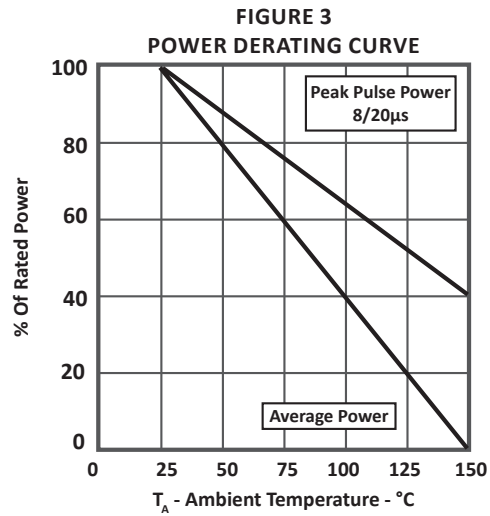

FIGURE 2  
PULSE WAVE FORM



## TYPICAL DEVICE CHARACTERISTICS



## APPLICATION INFORMATION

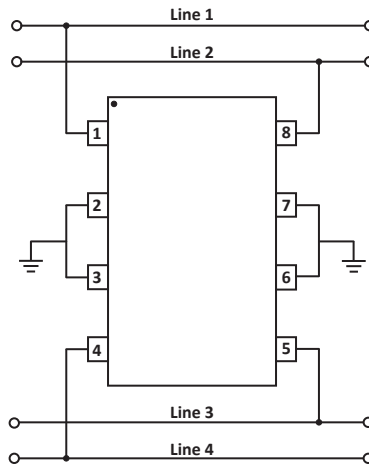

**FIGURE 1 - BIDIRECTIONAL COMMON-MODE PROTECTION**

The SLVU2.8-8 provides 4 lines of protection in a common mode configuration. Circuit connectivity is as follows:

- Line 1 connected to Pin 1
- Line 2 connected to Pin 8
- Line 3 connected to Pin 5
- Line 4 connected to Pin 4
- Pins 2, 3, 6, 7 are connected to ground

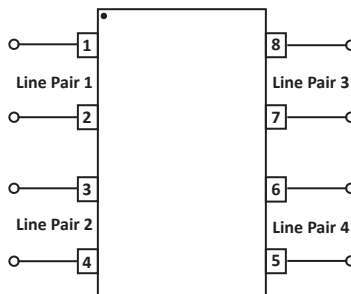

**FIGURE 2 - BIDIRECTIONAL DIFFERENTIAL-MODE PROTECTION**

The SLVU2.8-8 provides four line pairs in a differential mode configuration. Circuit connectivity is as follows:

- Line Pair 1 connected to Pins 1 & 2
- Line Pair 2 connected to Pins 3 & 4
- Line Pair 3 connected to Pins 5 & 6
- Line Pair 4 connected to Pins 7 & 8

## CIRCUIT BOARD RECOMMENDATIONS

Circuit board layout is critical for electromagnetic compatibility protection. The following guidelines are recommended:

- The protection device should be placed near the input terminals or connectors, the device will divert the transient current immediately before it can be coupled into the nearby traces.
- The path length between the TVS device and the protected line should be minimized.
- All conductive loops including power and ground loops should be minimized.
- The transient current return path to ground should be kept as short as possible to reduce parasitic inductance.
- Ground planes should be used whenever possible. For multilayer PCBs, use ground vias.

## SO-8 PACKAGE INFORMATION

## OUTLINE DIMENSIONS

DIM	MILLIMETERS		INCHES	
	MIN	MAX	MIN	MAX
A	4.80	5.00	0.189	0.196
B	3.80	4.00	0.150	0.157
C	1.35	1.75	0.054	0.068
D	0.35	0.49	0.014	0.019
F	0.40	1.25	0.016	0.049
G	1.27 BSC		0.05 BSC	
J	0.18	0.25	0.007	0.009
K	0.10	0.25	0.004	0.008
P	5.80	6.20	0.229	0.244
R	0.25	0.50	0.010	0.019

## NOTES

- T = Seating plane and datum surface.
- Dimensions "A" and "B" are datum.
- Dimensions "A" and "B" do not include mold protrusion.
- Maximum mold protrusion is 0.015" (0.380mm) per side.
- Dimensioning and tolerances per ANSI Y14.5M, 1982.
- Dimensions are exclusive of mold flash and metal burrs.

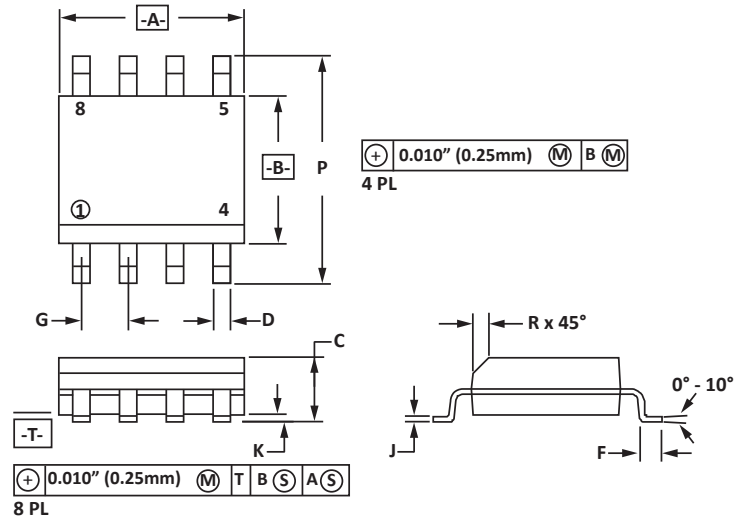

## PAD LAYOUT DIMENSIONS

DIM	MILLIMETERS		INCHES	
	MIN	MAX	MIN	MAX
A	1.14	1.40	0.045	0.055
B	0.64	0.89	0.025	0.035
C	6.22	-	0.245	-
D	3.94	4.17	0.155	0.165
E	1.02	1.27	0.040	0.050

## NOTES

- Controlling dimension: inches.

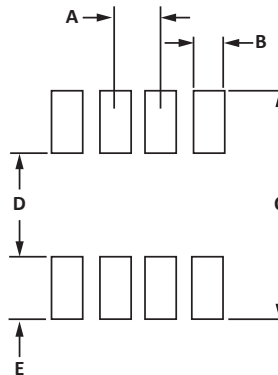

## TAPE AND REEL

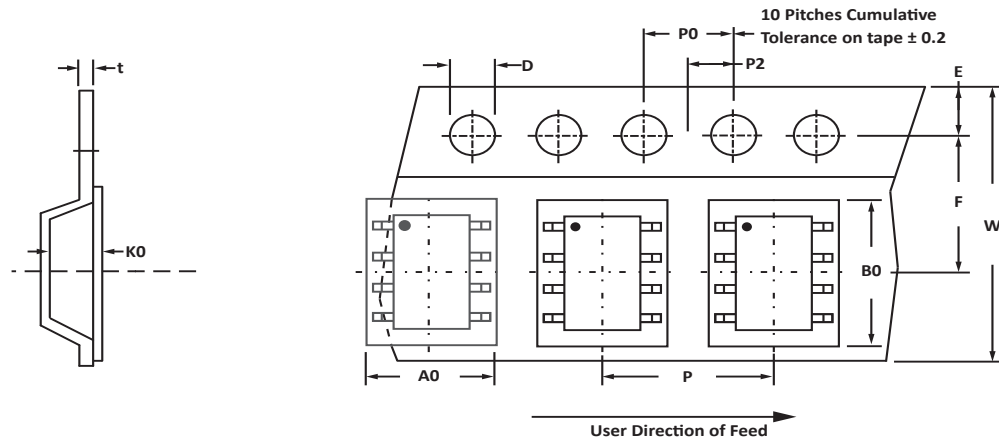

## SPECIFICATIONS

REEL DIA.	TAPE WIDTH	A0	B0	K0	D	E	F	W	P0	P2	P	tmax
178mm (7")	12mm	6.50 ± 0.10	5.40 ± 0.10	2.00 ± 0.10	1.50 ± 0.10	1.75 ± 0.10	5.50 ± 0.05	12.00 ± 0.30	4.00 ± 0.12	2.00 ± 0.10	4.00 ± 0.10	0.25

## NOTES

- Dimensions are in millimeters.
- Surface mount product is taped and reeled in accordance with EIA-481.
- Suffix - T7 = 7" Reel - 1,000 pieces per 12mm tape.
- Suffix - T13 = 13" Reel - 2,500 pieces per 12mm tape.
- Bulk product shipped in tubes of 98 pieces per tube.
- Marking on Part - marking code (see page 2), date code, logo and pin one defined by dot on top of package.

Package outline, pad layout and tape specifications per document number 06009.R3 9/10.

## ORDERING INFORMATION

BASE PART NUMBER	LEADFREE SUFFIX	TAPE SUFFIX	QTY/REEL	REEL SIZE	TUBE QTY
SLVU2.8-8	-LF	-T7	1,000	7"	98
SLVU2.8-8	-LF	-T13	2,500	13"	98

This device is only available in a Lead-Free configuration.

## COMPANY INFORMATION

---

### COMPANY PROFILE

In business more than 20 years, ProTek Devices™ is a privately-held company located in Tempe, Arizona, that offers a product line of transient voltage suppressors (TVS); avalanche breakdown diodes; steering diode TVS arrays and other surge suppressor component products. These TVS devices protect electronic systems from the effects of lightning, electrostatic discharge (ESD), nuclear electromagnetic pulses (NEMP), inductive switching and EMI / RFI. ProTek Devices also offers high performance interface and linear products that include analog switches; multiplexers; LED drivers; audio control ICs; RF and related high frequency products. The analog devices work in a host of consumer; industrial; automotive and other applications.

### CONTACT US

#### Corporate Headquarters

2929 South Fair Lane  
Tempe, Arizona 85282  
USA

#### By Telephone

General: 602-431-8101  
Sales: & Marketing: 602-414-5109  
Customer Service: 602-414-5114  
Product Technical Support: 602-414-5107

#### By Fax

General: 602-431-2288

#### By E-mail:

Sales: [sales@protekdevices.com](mailto:sales@protekdevices.com)  
Customer Service: [service@protekdevices.com](mailto:service@protekdevices.com)  
Technical Support: [support@protekdevices.com](mailto:support@protekdevices.com)

#### ProTek Devices (Asia Pacific) Pte. Ltd.

8 Ubi Road 2, #06-19  
Zervex  
Singapore - 408538  
Tel: +65-67488312  
Fax: +65-67488313

#### Web

[www.protekdevices.com](http://www.protekdevices.com)

COPYRIGHT © ProTek Devices 2007 - This literature is subject to all applicable copyright laws and is not for resale in any manner.

SPECIFICATIONS: ProTek reserves the right to change the electrical and or mechanical characteristics described herein without notice.

DESIGN CHANGES: ProTek reserves the right to discontinue product lines without notice and that the final judgement concerning selection and specifications is the buyer's and that in furnishing engineering and technical assistance. ProTek assumes no responsibility with respect to the selection or specifications of such products. ProTek makes no warranty, representation or guarantee regarding the suitability of its products for any particular purpose, nor does ProTek assume any liability arising out of the application or use of any product or circuit and specifically disclaims any and all liability without limitation special, consequential or incidental damages.

LIFE SUPPORT POLICY: ProTek Devices products are not authorized for use in life support systems without written consent from the factory.