

Customer : \_\_\_\_\_ 日鑫股份有限公司  
(客 戶)

Part No. : \_\_\_\_\_  
(貴公司料號)

# SPECIFICATION FOR APPROVAL

## 承 認 書

Description : \_\_\_\_\_ ALUMINUM ELECTROLYTIC CAPACITORS  
(零 件 名 稱)

Lelon Series : \_\_\_\_\_ RGA Series  
(立 隆 系 列)

Lelon Part No.: \_\_\_\_\_ RGA221M2ABK-1320G  
(立 隆 料 號)

### LELON ELECTRONICS CORP.

#### 立隆電子工業股份有限公司

#### Headquarters

147, Sec. 1, Guoguang Rd., Dali District, Taichung, Taiwan  
TEL: +886-4-24181856 FAX: +886-4-24181906

#### Manufacturing Sites

Lelon Electronics Corp.  
147, Sec. 1, Guoguang Rd., Dali District, Taichung, Taiwan  
TEL: +886-4-24181856 FAX: +886-4-24181906

Lelon Electronics (Huizhou) Co., Ltd.  
Taiyang Industrial Zone, Baihua Town, Huidong County, Huizhou City,  
Guangdong, China  
TEL: +86-752-8768222 FAX: +86-752-8768199

Lelon Electronics (Suzhou) Co., Ltd.  
1220, Zhongshan North Rd., Wujiang Economic and Technological Technological  
Development Zone Suzhou City, Jiangsu, China  
TEL: +86-512-63457588 FAX: +86-512-63457791

#### Approval Signatures

貴公司承認印

Approval 核 准	Check 確 認	Design 作 成
		

Please Return One Copy with Your Approval  
承認後請寄回本圖一份

## Part Numbering System

### Product Code Guide – Radial Type

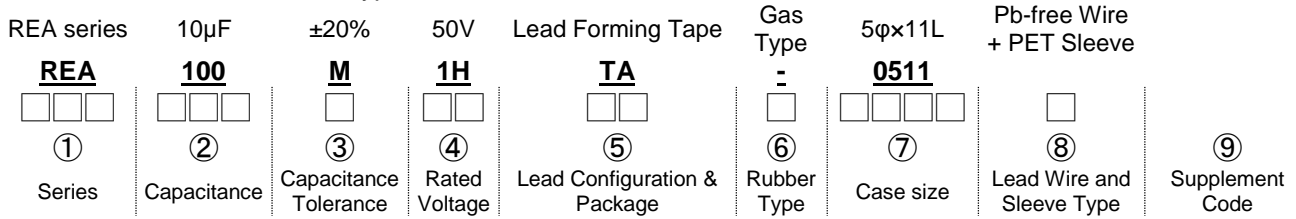

**① Series:**

Series is represented by a three-letter code. When the series name only has two letters, use a hyphen, "-", to fill the third blank.

**② Capacitance:**

Capacitance in μF is represented by a three-digit code. The first two digits are significant and the third digit indicates the number of zeros following the significant figure. "R" represents the decimal point for capacitance under 10μF.

Example:

Capacitance	0.1	0.47	1	4.7	10	47	100	470	1,000	4,700	10,000
Part number	0R1	R47	010	4R7	100	470	101	471	102	472	103

**③ Tolerance:**

J = -5% ~ +5%	K = -10% ~ +10%	M = -20% ~ +20%	V = -10% ~ +20%
---------------	-----------------	-----------------	-----------------

**④ Rated voltage:**

Rated voltage in volts (V) is represented by a two-digit code

Voltage (WV)	2.5	4	6.3	10	16	20	25	35	50	63	80	100
Code	0E	0G	0J	1A	1C	1D	1E	1V	1H	1J	1K	2A
Voltage (WV)	160	200	250	300	315	350	400	420	450	500	525	
Code	2C	2D	2E	2L	2F	2V	2G	2P	2W	2H	2Y	

**⑤ Lead configuration and package:**

BK = Bulk Package	TA = Formed Lead Taping
FC = Formed & Cut Lead	SA = Straight Lead Taping
CC = Cut Lead	SD = Bent Cathode Lead
SF = Snap-in & Formed Cut Lead	BC = Bent & Cut Lead (Leads in Right Direction)
SC = Snap-in & Cut Lead	BU = Bent & Cut Lead (Leads in Left Direction)

**⑥ Rubber type:**

- = Gas escape type	F = Flat rubber bung
---------------------	----------------------

Note : For case size of 3φ×5L, 12.5φ×16L, 16φ×16L, 16φ×20L, 18φ×16L, 18φ×20L, 18φ×25L of aluminum e-caps, flat rubber bung is the standard design. In these cases, use a hyphen, "-", in this digit.

**⑦ Case size:**

The first two digits indicate case diameter and the last two digits indicate case length in mm.

φD×L	3×5	4×5	4×7	5×5	5×7	5×11	6.3×5	6.3×7	6.3×11	6.3×15
Code	0305	0405	0407	0505	0507	0511	0605	0607	0611	0615
φD×L	8×5	8×7	8×9	8×11.5	8×15	8×20	10×9	10×12.5	10×16	10×20
Code	0805	0807	0809	0811	0815	0820	1009	1012	1016	1020
φD×L	10×25	10×30	10×35	10×40	10×45	10×50	12.5×16	12.5×20	12.5×25	12.5×30
Code	1025	1030	1035	1040	1045	1050	1316	1320	1325	1330
φD×L	12.5×35	12.5×40	12.5×45	12.5×50	16×16	16×20	16×25	16×31.5	16×35.5	16×40
Code	1335	1340	1345	1350	1616	1620	1625	1632	1636	1640
φD×L	16×45	16×50	18×16	18×20	18×25	18×31.5	18×35.5	18×40	18×45	18×50
Code	1645	1650	1816	1820	1825	1832	1836	1840	1845	1850
φD×L	20×30	20×35	22×35	22×40	22×45	25×40	25×45			
Code	2030	2035	2235	2240	2245	2540	2545			

Note: When a case size is required and not shown in the table, please contact with us for further discussion.

**⑧ Lead Wire and Sleeve Type:**

None = Standard design Pb-free wire + PET sleeve (aluminum e-cap) Pb-free wire + Coating case (OP-CAP)	T = Sn-Pb wire + PET sleeve
B = Sn-Bi wire + PET sleeve	G = Pb-free wire + Black PET sleeve (for RGA & SG series only)
K / L = Automotive control code	

\* When a supplement code following a blank digit code of lead wire and sleeve type (standard design), use a hyphen, "-", to fill the blank digit.

\* When the automotive control code is required, please contact with us for further discussion.

**⑨ Supplement code (Optional):**

For special control purposes

CUSTOMER : 日鑫股份有限公司

CUSTOMER P/N:

PRODUCT DIMENSIONS

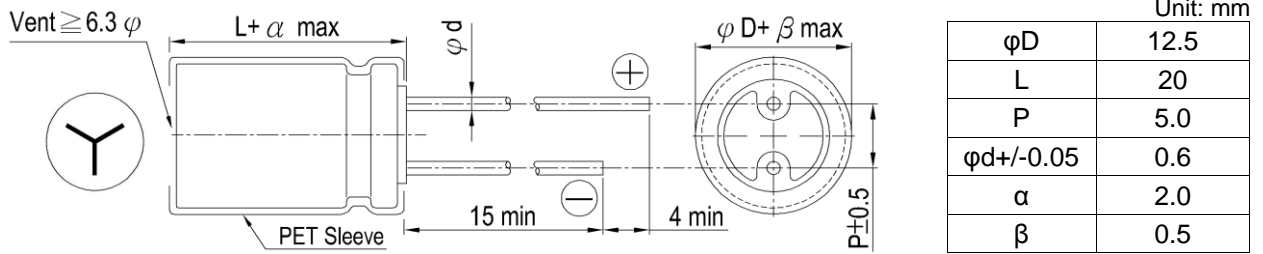

Items	Performance															
Rated Voltage $V_R$	100 V															
Capacitance $C_R$	220 $\mu$ F (120 Hz, 20 $^{\circ}$ C)															
Category Temperature Range	-40 $^{\circ}$ C ~ +105 $^{\circ}$ C															
Capacitance Tolerance	-20 % ~ +20 % (120 Hz, 20 $^{\circ}$ C)															
Surge Voltage $V_S$	115 $V_{DC}$															
Leakage Current (20 $^{\circ}$ C)	$I_{LEAK} \leq 220 \mu A$ After 2 minutes															
Tan $\delta$	$\leq 0.08$ (120 Hz, 20 $^{\circ}$ C)															
Ripple Current ( $I_{AC, R}$ /rms)	420 mA (120 Hz, 105 $^{\circ}$ C)															
Low Temperature Characteristics at 120 Hz	<table border="1" style="margin-left: 40px;"> <tr> <td rowspan="2">Impedance ratio</td> <td><math>Z_{(-25^{\circ}C)} / Z_{(+20^{\circ}C)}</math></td> <td>2</td> </tr> <tr> <td><math>Z_{(-40^{\circ}C)} / Z_{(+20^{\circ}C)}</math></td> <td>3</td> </tr> </table>	Impedance ratio	$Z_{(-25^{\circ}C)} / Z_{(+20^{\circ}C)}$	2	$Z_{(-40^{\circ}C)} / Z_{(+20^{\circ}C)}$	3										
Impedance ratio	$Z_{(-25^{\circ}C)} / Z_{(+20^{\circ}C)}$		2													
	$Z_{(-40^{\circ}C)} / Z_{(+20^{\circ}C)}$	3														
Ripple Current (A) and Frequency Multipliers	<table border="1" style="margin-left: 40px;"> <tr> <td>Frequency (Hz)</td> <td>60(50)</td> <td>120</td> <td>500</td> <td>1k</td> <td>10k up</td> </tr> <tr> <td>Multipliers</td> <td>0.75</td> <td>1.00</td> <td>1.20</td> <td>1.30</td> <td>1.35</td> </tr> </table>	Frequency (Hz)	60(50)	120	500	1k	10k up	Multipliers	0.75	1.00	1.20	1.30	1.35			
Frequency (Hz)	60(50)	120	500	1k	10k up											
Multipliers	0.75	1.00	1.20	1.30	1.35											
Endurance and Shelf Life Test	<table border="1" style="margin-left: 40px;"> <tr> <td>Items</td> <td>Endurance</td> <td>Shelf Life Test</td> </tr> <tr> <td>Test Time</td> <td>2,000 Hrs at 105<math>^{\circ}</math>C, <math>V_R</math>, <math>I_{AC, R}</math></td> <td>1,000 Hrs at 105<math>^{\circ}</math>C</td> </tr> <tr> <td>Cap. Change</td> <td>Within <math>\pm 20</math> % of initial value</td> <td>Within <math>\pm 20</math> % of initial value</td> </tr> <tr> <td>Tan <math>\delta</math></td> <td>Less than 200% of specified value</td> <td>Less than 200% of specified value</td> </tr> <tr> <td>Leakage Current</td> <td>Within specified value</td> <td>Within specified value</td> </tr> </table>	Items	Endurance	Shelf Life Test	Test Time	2,000 Hrs at 105 $^{\circ}$ C, $V_R$ , $I_{AC, R}$	1,000 Hrs at 105 $^{\circ}$ C	Cap. Change	Within $\pm 20$ % of initial value	Within $\pm 20$ % of initial value	Tan $\delta$	Less than 200% of specified value	Less than 200% of specified value	Leakage Current	Within specified value	Within specified value
Items	Endurance	Shelf Life Test														
Test Time	2,000 Hrs at 105 $^{\circ}$ C, $V_R$ , $I_{AC, R}$	1,000 Hrs at 105 $^{\circ}$ C														
Cap. Change	Within $\pm 20$ % of initial value	Within $\pm 20$ % of initial value														
Tan $\delta$	Less than 200% of specified value	Less than 200% of specified value														
Leakage Current	Within specified value	Within specified value														
Solder heat-resistance	During dip or wave soldering, temperature at the capacitors terminals should be less than 260 $\pm$ 5 $^{\circ}$ C, 10 $\pm$ 1 seconds.															
Standards	JIS C 5101-4, IEC 60384-4															
Remarks	RoHS Compliance, Halogen-free															

\* Please refer to "Precautions and Guidelines for Aluminum Electrolytic Capacitors" section in Lelon's catalog for further details.



Publication Date	July 4, 2018	Approval Signatures:	Approved	Checked	Designed
Revision Date					
Version No.	1		Please return one copy with your approval		

Diagram of Dimensions:



Lead Spacing & Diameter								Unit: mm	
φD	5	6.3	8	10	12.5	16	18	22	25
P	2.0	2.5	3.5	5.0	5.0	7.5	7.5	10	12.5
φd +/-0.05	0.5		0.6			0.8		1.0	
α	L < 20: 1.5, L ≥ 20: 2.0							2.0	
β	0.5								

The case size of 12.5x16, 16x16, 16x20, 18x16, 18x20 and 18x25 are suitable for below diagram:

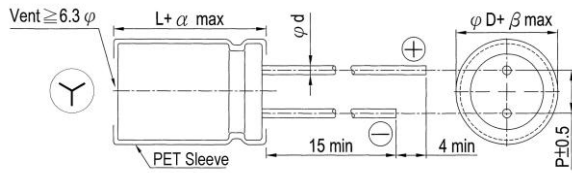
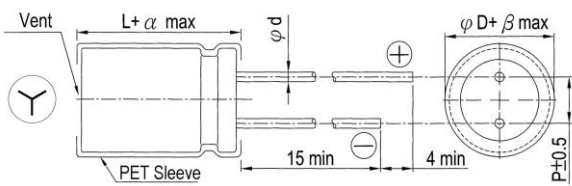

Marking:

Each capacitor shall be marked with the following information.

(The Front)

120μF 450V → Rated capacitance and rated DC working voltage  
 → Polarity

(The Back)

 → Brand name

RGA 105°C → Series & maximum operating temperature

H 8 01 (M) → Date code

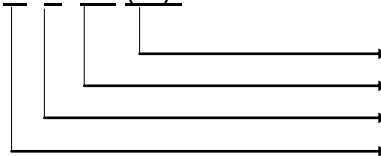
  
 Tolerance of capacitance  
 Week of manufacture  
 The last digit of A. D.  
 Place of manufacture  
 T: Taiwan  
 H: Huizhou  
 A: Suzhou

Appearance:

Marking color: White

Sleeve color: Black ----- RGA Series

Sleeve material: PET

Packaging Quantity:

Radial Type in Bulk Pack (Long Lead):

Case Size	Pcs / Bag	Inner Box / Carton	Pcs / Carton	Case Size	Pcs / Bag	Inner Box / Carton	Pcs / Carton
3φ × 5	1,000	-	60,000	10φ × 16L	500	-	7,000
4φ × 5 ~ 7L	1,000	-	50,000	10φ × 20 ~ 25L	500	-	6,000
5φ × 5 ~ 7L	1,000	-	40,000	10φ × 30 ~ 40L	400	-	4,000
*5φ × 8L	*1,000	-	*20,000	10φ × 45 ~ 50L	200	-	3,000
5φ × 11L	1,000	-	30,000	12.5φ × 16 ~ 25L	250	2	3,000
6.3φ × 5 ~ 7L	1,000	-	30,000	12.5φ × 30~ 35L	250	2	2,500
*6.3φ × 5.5 ~ 8L	*1,000	-	*20,000	12.5φ × 40L	250	2	2,000
6.3φ × 11L	1,000	-	20,000	12.5φ × 45 ~ 50L	100	2	2,000
	*1,000	-	*20,000	16φ × 16 ~ 25L	150	2	1,800
6.3φ × 15L	1,000	-	15,000	16φ × 31.5L	100	2	1,200
8φ × 5 ~ 9L	1,000	-	15,000	16φ × 35.5L	100	2	1,200
8φ × 11.5L	1,000	-	12,000	16φ × 40 ~ 50L	100	2	1,000
*8φ × 8L~12L	*1,000	-	*12,000	18φ × 16L	150	2	1,800
8φ × 15L	1,000	-	10,000	18φ × 20 ~ 31.5L	100	2	1,200
8φ × 20L	1,000	-	8,000	18φ × 35.5~40L	100	2	800
8φ × 25 ~ 30L	500	-	6,000	18φ × 45 ~ 50L	50	2	600
8φ × 35 ~ 50L	250	-	3,000	20φ × 40L	50	2	600
*10φ × 7.7 ~10L	*500	-	*10,000	22φ	50	2	500
10φ × 9L	1,000	-	12,000	25φ × 40L	25	2	300
10φ × 12.5 ~13L	500	-	8,000	25φ × 45 ~ 50L	25	2	250

Remark: "\*" Suitable for CAP04 type (OP-CAP).

Packing Figure:

a) Inner Box

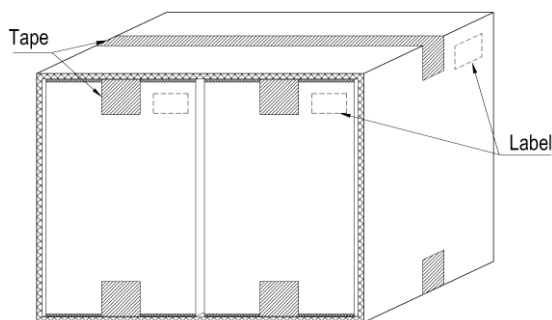

b) Outer Box Unit: mm

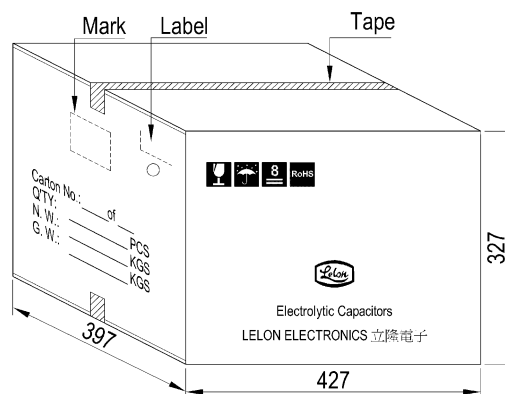

b) Label



## Endurance Characteristic:

No.	Item	Conditions	Specification	
1	Rotational Temperature Test	Capacitor is placed in an oven whose temperature follow specific regulation to “ +25°C (3 min.) → -40°C / -25°C (30 min.) → +25°C (3 min.) → +105°C (30 min.) → +25°C (3 min.)”, and it is called a cycle. The test totals 10 cycles. And then the capacitor shall be subjected to standard atmospheric conditions for 4 hours, after which measurements shall be made. 6.3 ~ 400V: -40°C; 450V: -25°C	Capacitance change	Within ± 10% of initial value.
			Tanδ	Within specified value
			Leakage Current	Within specified value
			Physical	No broken and undamaged
2	High Temperature Endurance Life Test	1. Capacitors shall be placed in oven with application of ripple current and rated voltage for 2000 +72 / -0 hours at 105°C. 2. The capacitor should be used within specified permissible ripple current in each standard products table (the sum of DC voltage and AC peak voltage shall be equal to the rated DC working voltage).3. The specified maximum permissible ripple current in defined at 105°C and 120Hz (unless otherwise specified). 4. Then the capacitor shall be subjected to standard atmospheric conditions for 4 hours, after which measurements shall be made.	Capacitance change	Within ± 20% of initial value.
			Tanδ	Less than 200% of specified value
			Leakage Current	Within specified value
			Physical	No broken and undamaged
3	High Temperature Unload Life Test	After 1000 +48 / -0 hours test at 105°C without rated working voltage. And then the capacitor shall be subjected to standard atmospheric conditions for 4 hours, after which measurements shall be made. The rated voltage shall be applied to the capacitors before the measurements for 160 ~ 450V (Refer to JIS C 5101-4 4.1)	Capacitance change	Within ± 20% of initial value.
			Tanδ	Less than 200% of specified value
			Leakage Current	Within specified value
			Physical	No broken and undamaged
4	Humidity Test	Capacitors shall be exposed for 1000 +48 / -0 hours in an atmosphere of 90% ~ 95% R. H. at 60 ± 3°C. And then the capacitor shall be subjected to standard atmospheric conditions for 4 hours, after which measurements shall be made.	Capacitance change	Within ± 10% of initial value.
			Tanδ	Less than 120% of specified value
			Leakage Current	Within specified value
			Physical	No broken and undamaged
5	Low Temperature Test	Capacitors are placed at -40 / -25 ± 3°C for 96 ± 4 hours. And then the capacitor shall be subjected to atmospheric conditions for 4 hours, after which measurements shall be made. 6.3 ~ 400V: -40°C; 450V: -25°C	Capacitance change	Within ± 10% of initial value.
			Tanδ	Within specified value
			Leakage Current	Within specified value
			Physical	No broken and undamaged
6	Vibration Test	1. Fix it at the point 4mm or less form body. For ones of 12.5mm or more in diameter or 25 mm or more length, use separate fixture. 2. Direction and during of vibration: 3 orthogonal directions mutually each for 2 hours (total of 6 hours). 3. Frequency: 10 to 55 Hz reciprocation for 1min. 4. Total amplitude: 1.5mm	Capacitance change	Within ± 10% of initial value.
			Tanδ	Within specified value
			Leakage Current	Within specified value
			Physical	No broken and undamaged
7	Solder Heat-Resistance Test	The section of lead below 4mm form the body of capacitor must be immersed in 260 ± 5°C liquid tin 10 ± 1 seconds, than, after removing the following specifications shall be satisfied when capacitor terminal is restored to 20°C over 4 hours.	Capacitance change	Within ± 10% of initial value.
			Tanδ	Within specified value
			Leakage Current	Within specified value
			Physical	No broken and undamaged

No.	Item	Conditions	Specification																																				
8	Surge Voltage Test	The capacitor shall be subjected to 1000 cycles at 15 ~ 35°C. Protective series resistor a 1KΩ each consisting of a charge period of 30 ± 5 seconds, followed by discharge period of approximately 5.5 minutes.  Applying voltage:	Capacitance change	Within ± 20% of initial value.																																			
			Tanδ	Less than 175% of specified value																																			
			Leakage Current	Within specified value																																			
			Physical	No broken and undamaged																																			
<table border="1"> <tbody> <tr> <td>Rated Voltage(V)</td> <td>6.3</td> <td>10</td> <td>16</td> <td>25</td> <td>35</td> <td>50</td> <td>63</td> <td>100</td> </tr> <tr> <td>Surge Voltage(V)</td> <td>7.3</td> <td>11.5</td> <td>18.4</td> <td>28.8</td> <td>40.3</td> <td>57.5</td> <td>72.5</td> <td>115</td> </tr> <tr> <td>Rated Voltage(V)</td> <td>160</td> <td>200</td> <td>250</td> <td>300</td> <td>350</td> <td>400</td> <td>450</td> <td></td> </tr> <tr> <td>Surge Voltage(V)</td> <td>184</td> <td>230</td> <td>288</td> <td>345</td> <td>385</td> <td>440</td> <td>495</td> <td></td> </tr> </tbody> </table>			Rated Voltage(V)	6.3	10	16	25	35	50	63	100	Surge Voltage(V)	7.3	11.5	18.4	28.8	40.3	57.5	72.5	115	Rated Voltage(V)	160	200	250	300	350	400	450		Surge Voltage(V)	184	230	288	345	385	440	495		
Rated Voltage(V)	6.3	10	16	25	35	50	63	100																															
Surge Voltage(V)	7.3	11.5	18.4	28.8	40.3	57.5	72.5	115																															
Rated Voltage(V)	160	200	250	300	350	400	450																																
Surge Voltage(V)	184	230	288	345	385	440	495																																
9	Mechanical Characteristics Test	<p>1. The test is about lead tabs strength.</p> <p>2. Tension Test: The lead tabs shall not be broken or any malformed condition after fixing capacitor vertically and pressing the following weight on the lead tabs of capacitor for 10 ± 1 secs.</p> <table border="1"> <thead> <tr> <th>Lead tabs diameter (mm)</th> <th>Weight (Kg)</th> </tr> </thead> <tbody> <tr> <td>≤ 0.5</td> <td>0.5</td> </tr> <tr> <td>0.6 ~ 0.8</td> <td>1.0</td> </tr> <tr> <td>&gt; 0.8</td> <td>2.0</td> </tr> </tbody> </table> <p>3. Bending Test: The capacitor is held in vertical position. Attach a weight to the lead tabs, slowly rotate the capacitor 90° to a same way in the opposite direction. Repeat it again (5 secs / cycle). The lead tabs shall not be broken or cracked.</p> <table border="1"> <thead> <tr> <th>Lead tabs diameter (mm)</th> <th>Weight(Kg)</th> </tr> </thead> <tbody> <tr> <td>≤ 0.5</td> <td>0.25</td> </tr> <tr> <td>0.6 ~ 0.8</td> <td>0.50</td> </tr> <tr> <td>&gt; 0.8</td> <td>1.00</td> </tr> </tbody> </table>	Lead tabs diameter (mm)	Weight (Kg)	≤ 0.5	0.5	0.6 ~ 0.8	1.0	> 0.8	2.0	Lead tabs diameter (mm)	Weight(Kg)	≤ 0.5	0.25	0.6 ~ 0.8	0.50	> 0.8	1.00																					
			Lead tabs diameter (mm)	Weight (Kg)																																			
			≤ 0.5	0.5																																			
			0.6 ~ 0.8	1.0																																			
> 0.8	2.0																																						
Lead tabs diameter (mm)	Weight(Kg)																																						
≤ 0.5	0.25																																						
0.6 ~ 0.8	0.50																																						
> 0.8	1.00																																						
10	Solderability Test	After the lead wire fully immersed in the solder for 2 ± 0.5 secs at a temperature of 245 ± 5°C, the solder coating must be more than 95%.																																					
11	Venting Test	<p>1. Applicable to the capacitors with case diameter is 6.3 mm and larger.</p> <p>2. Test condition:</p> <p>(1) AC test: The capacitor shall be connected across a applying 50 or 60 Hz AC which is 0.7 times of rated voltage or 250Vrms AC whichever is the lower.</p> <p>(2) DC test: Applying inverse DC rated voltage with current to the capacitor. Where case diameter: φD ≤ 22.4mm: 1 A DC max φD &gt; 22.4mm: 10 A DC max</p> <p>Note:</p> <p>(1) When the pressure relief vent operated, the capacitor shall avoid any danger of fire or explosion of capacitor element (terminal and metal foil etc.) or cover.</p> <p>(2) When the pressure relief device does not open with the voltage applied over 30 minutes, the test is considered to be passed.</p>																																					
12	Standards	Satisfies Characteristic JIS C 5101-4																																					

## Precautions and Guidelines for Aluminum Electrolytic Capacitors

### 1. Guidelines for Circuit Design (General / Application guidelines for using electrolytic capacitors)

#### Selecting of a right capacitor is a key to a good circuit design.

##### (1) Polarity

Most of the aluminum electrolytic capacitors are polarized. Therefore, they must be installed with the correct polarity. Usage in the reverse polarity results into a short-circuit condition that may damage or even explode the capacitor. In addition, it may influence circuit functionality. A bi-polar electrolytic capacitor should be installed when polarity across a capacitor is unstable / reversible. It should be, however, noted that usage of both polar and bi-polar capacitors are limited to DC applications. They must NOT be used for AC application.

##### (2) Operating Voltage

Applied DC voltage must not exceed rated voltage of the capacitor. Applying higher voltage than its rated voltage across a capacitor terminals cause overheating due to higher leakage currents and capacitor dielectric/insulation deterioration that will ultimately affect a capacitor's performance. The device, however, is capable of working under short-time transient voltages such as DC transients and peak AC ripples. Reverse voltages higher than 1 Volt with a specified temperature limit or AC voltages are not permissible. Overall, using capacitors at recommended operating voltages can prolong its lifespan. Note that the result of DC voltage overlapped with peak ripple voltage should not exceed rated voltage.

##### (3) Ripple Current

One of the key functions of any capacitor is removal of the ripple current i.e. the RMS value of AC flowing through a capacitor. But, a ripple current higher than rated ripple current will drop resultant capacitance, cause undue internal heating and thus reduces life span of the capacitor. In extreme cases, internal high temperature will cause the pressure relief vent to operate while destroying the device. Overall, it is important to note that an electrolytic capacitor must be used within a permissible range of ripple current. Indicators like temperature coefficient of allowable ripple current are generally used to determine life expectancy of the capacitor, but to avoid related complex calculations and for the sake of simplicity, we haven't provided temperature coefficient in the catalogue. But it offers key indicators like maximum operating temperature for calculation of life expectancy at a given temperature.

##### (4) Operating Temperature

Capacitors should be used within a permissible range of operating temperatures. Using capacitor at a higher temperature than maximum rated temperature will considerably shorten its life. In the worst-case scenario, high temperature can cause pressure relief vent to operate and the device will get destroyed. Using capacitors at an ambient room temperature assure their longer life.

##### (5) Leakage Current

Leakage current flows through a capacitor when DC voltage is applied across it. Leakage current varies with changes in ambient temperature and applied DC voltage level and its time of application. Overvoltage situation, presence of moisture, and thermal stresses, especially occurring during the soldering process can enhance leakage current. Initial leakage current is usually higher and does not decrease until voltage is applied for a certain period of time. It is recommended to keep initial leakage current within specified levels.

##### (6) Charge and Discharge

Regular electrolytic capacitors are not suitable for rapid charging/discharging circuits. Such usage may either cause reduction in overall capacitance or damage due to overheating. Leon provides special assistance for selecting appropriate capacitors for rapid charging/discharging circuits.

##### (7) Surge Voltage

The Surge voltage rating is referred as the maximum DC overvoltage that may be applied to an electrolytic capacitor for a short time interval of 30 seconds at infrequent or infrequent time intervals not exceeding 5.5minutes with a limiting resistance of 1k $\Omega$ . Unless otherwise described on the catalogue or product specifications, please do not apply a voltage exceeding the capacitor's voltage rating. The rated surge voltages corresponding to rated voltages of electrolytic capacitors are presented as follows:

Rated Voltage(V)	4	6.3	10	16	25	35	50
Surge Voltage(V)	4.6	7.3	11.5	18.4	28.8	40.3	57.5

Rated Voltage(V)	63	80	100	160	200	250	315
Surge Voltage(V)	72.5	92	115	184	230	288	347

Rated Voltage(V)	350	400	420	450	500	525
Surge Voltage(V)	385	440	462	495	550	578

##### (8) Surge Voltage

The capacitor shall NOT be exposed to:

- Fluids including water, saltwater spray, oil, fumes, highly humid or condensed climates, etc.
- Ambient conditions containing hazardous gases/fumes like hydrogen sulfide, sulfuric acid, nitrous acid, chlorine or bromine gas, ammonia, etc.
- Exposed to ozone, ultraviolet rays and radiation.
- Severe vibrations or physical shocks that exceeds the specifications mentioned in this catalogue.

##### (9) Circuit Design Consideration

- Please ensure whether application, operating and mounting conditions satisfy the conditions specified in the catalog before installation of a capacitor. Please consult Lelon, if any of the conditions are beyond the conditions specified in the catalog.
- Heat-generating components or heat sinks should not be placed closer to Aluminum electrolytic capacitors on the PCB to avoid their premature failure. A cooling system is recommended to improve their reliable working.
- Electrical characteristics and performance of aluminum electrolytic capacitors are affected by variation of applied voltage, ripple current, ripple frequency and operating temperature. Therefore, these parameters shall not exceed specified values in the catalog.
- Aluminum capacitors may be connected in the parallel fashion for increasing total capacitance and/or for achieving higher ripple current capability. But, such design may cause unequal current flow through each of the capacitors due to differences in their impedances.
- When two or more capacitors are connected in series, voltage across each capacitor may differ and fall below the applied voltage. A resistor should be placed across each capacitor so as to match applied voltage with voltage across a capacitor.
- Please consult Lelon while selecting a capacitor for high-frequency switching circuit or a circuit that undergoes rapid charging/ discharging.
- Standard outer sleeve of the capacitor is not a perfect electrical insulator therefore is unsuitable for the applications that requires perfect electrical insulation. Please consult Lelon, if your application requires perfect electrical insulation.
- Tilting or twisting capacitor body is not recommended once it is soldered to the PCB.

## 2. Caution for Assembling Capacitors

### (1) Mounting

- Aluminum electrolytic capacitors are not recommended to reuse in other circuits once they are mounted and powered in a circuit.



- (b) Aluminum electrolytic capacitors may hold static charge between its anode and cathode, which is recommended to be discharged through a 1kΩ resistor before re-use.
- (c) A long storage of capacitors may result into its insulation deterioration. This can lead to a high leakage current when voltage is applied that may damage the capacitor. Capacitors following a long storage period must undergo voltage treatment/re-forming.  
Capacitors are charged by applying rated DC voltage through a resistor of 1kΩ in series at least for an hour. It is recommended to increase applied voltage gradually using a voltage regulator unit once capacitors are assembled on the board. The charging should be followed by discharging through a 1KΩ resistor.
- (d) Please check capacitor rated voltage before mounting.
- (e) Please check capacitor polarity before mounting.
- (f) Please don't drop capacitor on the floor / hard object.
- (g) Please don't deform the capacitor during installation.
- (h) Please confirm whether the lead spacing of the capacitors match with its pad spacing / footprint on PCB prior to installation.
- (i) Please avoid excessive mechanical shocks to capacitor during the auto-insertion process, inspection or centering operations.
- (j) Please don't place any wiring or circuit over the capacitor's pressure relief vent. The pressure relief vent may fail to open if adequate clearance space is not provided. Following table shows minimum clearance space required for different case diameters.

Case Diameter	φ6.3 ~ φ16	φ18 ~ φ35	φ40 or above
Clearance(mm)	2 mm	3 mm	5 mm

**(2) Soldering**

- (a) Please confirm that soldering conditions, especially temperature and contact time are within our specifications. Dip or flow soldering temperature should be limited at 260 ± 5 °C for 10 ± 1 sec while manual soldering using soldering iron should be limited at 350 ± 5°C for 3 +1/-0 seconds. Please do not dip capacitor body into molten solder. A capacitor's life will be negatively affected if these conditions are violated.
- (b) Storage of capacitors in high humidity conditions is likely to affect the solder-ability of lead wires and terminals.

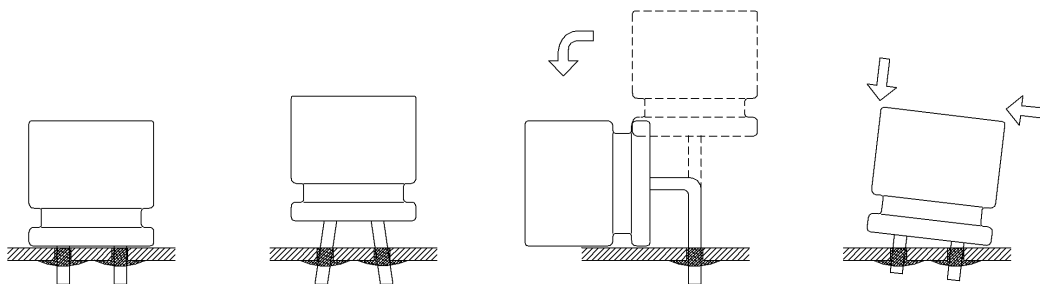

- (c) **Reflow soldering should NOLY be used for SMD type capacitors.** The temperature and duration shall not exceed the specified temperature and duration in the specification. If the temperature or duration is higher than the value specified, please consult Lelon before usage.
- (d) Standard aluminum electrolytic capacitors are not designed to withstand multiple reflow processes. Please consult Lelon if repeated reflowing is unavoidable.
- (e) Incorrect mounting on PCB with improper external strength applied on its lead wires or capacitor body after soldering may damage a capacitor's internal structure, cause short circuit, or lead to high leakage current issues. Do not bend or twist the capacitor body after soldering. Referring to the drawings below only case (i) is recommended.
  - (i) Correct soldering
  - (ii) Hole-to-hole spacing on PCB differs from the lead space of lead wires.
  - (iii) Lead wires are bent after soldering.
  - (iv) Capacitor body doesn't stand vertical on PCB after soldering.

**(3) Cleaning Circuit Boards after Soldering**

- (a) Following chemicals are not recommended for cleaning: Solvent containing halogen ions, Alkaline solvent, Xylene, Acetone, Terpene, petro-based solvent.
- (b) Recommended cleaning conditions: Fatty-alcohol - Pine Alpha ST-100S, Clean Through-750H and IPA (isopropyl alcohol) are examples of the most acceptable cleaning agents. Temperature of the cleaning agent must not exceed 60°C. Flux content in the cleaning agents should be limited to 2 Wt. %. Overall length of cleaning process (e.g., immersion, ultrasonic or other) shall be within 5 minutes (5 ~ 7mm height within 3 minutes). CFC substitute cleaning agents such as AK225AES can also be used for cleaning. In this case, its temperature shall not exceed 40 C and cleaning process (e.g., immersion, ultrasonic or other) shall be completed within 2 ~ 3 minutes. After cleaning capacitors should be dried with hot air for at least 10 minutes along with the PCB. Temperature of hot air shall not exceed maximum category temperature of the capacitor. Insufficient drying may cause appearance defects, sleeve shrinkage, and bottom-plate bulging. However, usage of this CFC substitute must completely regulated for protection of environment.

**3. Maintenance Inspection**

Periodical inspection of aluminum capacitors is absolutely necessary especially when they are used with industrial equipment. The following items should be checked:

- (1) Appearance: Bloated, vent operated, leaked, etc.
- (2) Electrical characteristic: Capacitance, Tanδ, leakage current, and other specified items listed in specification.

Lelon recommend replacing the capacitors if any of the abovementioned items fail to meet specifications.

**4. Storage**

- (1) The most suitable conditions for aluminum capacitor storage are 5 °C ~ 35°C and indoor relative humidity less than 75%. High temperature and/or humidity storage is detrimental to the capacitors.
- (2) Capacitors shall not be stored in wet or damp atmospheres containing water, brine, fumes or oil.
- (3) Capacitors storage area shall neither be exposed to hazardous gases such as hydrogen sulfide, sulfurous acid, nitrous acid, chlorine, ammonium, etc. nor to acidic or alkaline solutions.
- (4) Capacitors shall not be exposed to ozone, ultraviolet rays or radiation.

**5. Maintenance Inspection**

Please consult with a local industrial waste disposal specialist when disposing of aluminum electrolytic capacitors.

**6. Environmental Consideration**

Lelon already have received ISO 14000 certificate. Cadmium (Cd), Lead (Pb), Mercury (Hg), Hexavalent Chromium (Cr+6), PBB, PBDE, DEHP, BBP, DBP and DIBP have never been using in capacitor. If you need "Halogen-free" products, please consult with us.

**7. AEC-Q200 Compliance**

Automotive Electronics Counsel (AEC) has established various electronic component qualification/reliability standards in order to serve automotive electronics industry. AEC-Q200 standard is dedicated for passive components like capacitors, inductors, etc. and is widely adopted domestically as well as internationally.

Lelon offers compliant product designs and support services to satisfy customers' product requirements, including the ACE-Q200 required criteria of the reliability tests. Lelon's capacitors are professionally designed to outperform all requirements of ACE-Q200.

For further details, please refer to the following industrial standards:

IEC 60384-4- Fixed capacitors for use in electronic equipment – Part 4: Sectional specification – Aluminum electrolytic capacitors with solid (MnO<sub>2</sub>) and non-solid electrolyte (Established in January 1995, Revised in March 2007)

EIAJ RCR-2367B- Guideline of notabilia for fixed aluminum electrolytic capacitors for use in electronic equipment [Technical Standardization Committee on Passive Components (Established in March 1995, Revised in March 2002)].