



SPI/I²C Compatible, Temperature Sensor, 4-Channel ADC and Quad Voltage Output DAC

ADT7516/ADT7517/ADT7519

FEATURES

- ADT7516—four 12-bit DACs
- ADT7517—four 10-bit DACs
- ADT7519—four 8-bit DACs
- Buffered voltage output
- Guaranteed monotonic by design over all codes
- 10-bit temperature-to-digital converter
- 10-bit 4-channel ADC
- DC input bandwidth
- Input range: 0 V to 2.28 V
- Temperature range: -40°C to +120°C
- Temperature sensor accuracy of typ: ±0.5°C
- Supply range: 2.7 V to 5.5 V
- DAC output range: 0 V to 2 V_{REF}
- Power-down current: 1 μA
- Internal 2.28 V_{REF} option
- Double-buffered input logic
- Buffered reference input
- Power-on reset to 0 V DAC output
- Simultaneous update of outputs (LDAC function)
- On-chip rail-to-rail output buffer amplifier
- SPI[®], I²C[®], QSPI[™], MICROWIRE[™], and DSP compatible
- 4-wire serial interface
- SMBus packet error checking (PEC) compatible
- 16-lead QSOP package

GENERAL DESCRIPTION

The ADT7516/ADT7517/ADT7519¹ combine a 10-bit temperature-to-digital converter, a 10-bit 4-channel ADC, and a quad 12-/10-/8-bit DAC, respectively, in a 16-lead QSOP package. The parts also include a band gap temperature sensor and a 10-bit ADC to monitor and digitize the temperature reading to a resolution of 0.25°C.

The ADT7516/ADT7517/ADT7519 operate from a single 2.7 V to 5.5 V supply. The input voltage range on the ADC channels is 0 V to 2.28 V, and the input bandwidth is dc. The reference for the ADC channels is derived internally. The output voltage of the DAC ranges from 0 V to V_{DD}, with an output voltage settling time of 7 ms typical.

The ADT7516/ADT7517/ADT7519 provide two serial interface options: a 4-wire serial interface that is compatible with SPI, QSPI, MICROWIRE, and DSP interface standards, and a 2-wire

APPLICATIONS

- Portable battery-powered instruments
- Personal computers
- Smart battery chargers
- Telecommunications systems
- Electronic text equipment
- Domestic appliances
- Process control

PIN CONFIGURATION

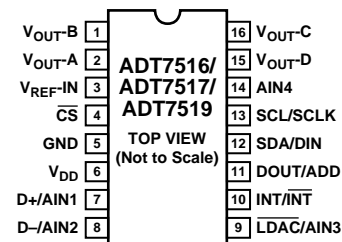

Figure 1.

02885A-006

SMBus/I²C interface. They feature a standby mode that is controlled through the serial interface.

The reference for the four DACs is derived either internally or from a reference pin. The outputs of all DACs may be updated simultaneously using the software LDAC function or the external LDAC pin. The ADT7516/ADT7517/ADT7519 incorporate a power-on reset circuit, which ensures that the DAC output powers up to 0 V and remains there until a valid write takes place.

The ADT7516/ADT7517/ADT7519's wide supply voltage range, low supply current, and SPI/I²C compatible interface make them ideal for a variety of applications, including personal computers, office equipment, and domestic appliances.

¹ Protected by the following U.S. Patent Numbers: 6,169,442; 5,867,012; 5,764,174. Other patents pending.

Rev. A

Information furnished by Analog Devices is believed to be accurate and reliable. However, no responsibility is assumed by Analog Devices for its use, nor for any infringements of patents or other rights of third parties that may result from its use. Specifications subject to change without notice. No license is granted by implication or otherwise under any patent or patent rights of Analog Devices. Trademarks and registered trademarks are the property of their respective owners.

TABLE OF CONTENTS

Specifications.....	3	Conversion Speed.....	19
DAC AC Characteristics.....	6	Function Description—Voltage Output.....	20
Functional Block Diagram	8	Function Description—Analog Inputs.....	23
Absolute Maximum Ratings.....	9	ADC Transfer Function.....	23
ESD Caution.....	9	Function Description—Measurement.....	25
Pin Configuration and Functional Descriptions.....	10	ADT7516/ADT7517/ADT7519 Registers.....	28
Terminology	11	Serial Interface	37
Typical Performance Characteristics	13	SMBus Alert Response.....	43
Theory of Operation	19	Outline Dimensions	44
Power-Up Calibration.....	19	Ordering Guide	44

REVISION HISTORY

8/04—Data Sheet Changed from Rev. 0 to Rev. A

Updated Format.....	Universal
Deleted ADT7518	
Added ADT7519.....	Universal
Change to Internal V_{REF} Value.....	5
Change to Equation.....	26

7/03—Initial Version: Rev. 0

SPECIFICATIONS

Table 1. Temperature range is as follows: A version: -40°C to $+120^{\circ}\text{C}$. $V_{\text{DD}} = 2.7\text{ V}$ to 5.5 V , $\text{GND} = 0\text{ V}$, $\text{REF}_{\text{IN}} = 2.25\text{ V}$, unless otherwise noted.

Parameter ¹	Min	Typ	Max	Unit	Conditions/Comments
DAC DC PERFORMANCE^{2,3}					
ADT7519					
Resolution		8		Bits	Guaranteed monotonic over all codes.
Relative Accuracy		± 0.15	± 1	LSB	
Differential Nonlinearity		± 0.02	± 0.25	LSB	
ADT7517					
Resolution		10		Bits	Guaranteed monotonic over all codes.
Relative Accuracy		± 0.5	± 4	LSB	
Differential Nonlinearity		± 0.05	± 0.5	LSB	
ADT7516					
Resolution		12		Bits	Guaranteed monotonic over all codes.
Relative Accuracy		± 2	± 16	LSB	
Differential Nonlinearity		± 0.02	± 0.9	LSB	
Offset Error		± 0.4	± 2	% of FSR	Lower deadband exists only if offset error is negative. See Figure 8.
Gain Error		± 0.3	± 2	% of FSR	
Lower Deadband		20	65	mV	Upper deadband exists if $V_{\text{REF}} = V_{\text{DD}}$ and off-set plus gain error is positive. See Figure 9.
Upper Deadband		60	100	mV	
Offset Error Drift ⁴		-12		ppm of FSR/ $^{\circ}\text{C}$	$\Delta V_{\text{DD}} = \pm 10\%$.
Gain Error Drift		-5		ppm of FSR/ $^{\circ}\text{C}$	
DC Power Supply Rejection Ratio		-60		dB	See Figure 5.
DC Crosstalk		200		μV	
ADC DC ACCURACY					
Resolution			10	Bits	Max $V_{\text{DD}} = 5\text{ V}$.
Total Unadjusted Error (TUE)		2	3	% of FSR	
Offset Error			± 0.5	% of FSR	
Gain Error			± 2	% of FSR	
ADC BANDWIDTH					
			DC	Hz	
ANALOG INPUTS					
Input Voltage Range	0		2.28	V	AIN1 to AIN4. C4 = 0 in Control Configuration 3.
	0		V_{DD}	V	
DC Leakage Current			± 1	μA	AIN1 to AIN4. C4 = 0 in Control Configuration 3.
Input Capacitance		5	20	pF	
Input Resistance		10		$\text{M}\Omega$	
THERMAL CHARACTERISTICS					
INTERNAL TEMPERATURE SENSOR					
Accuracy @ $V_{\text{DD}} = 3.3\text{ V} \pm 10\%$			± 1.5	$^{\circ}\text{C}$	Internal reference used. Averaging on.
		± 0.5	± 3	$^{\circ}\text{C}$	
Accuracy @ $V_{\text{DD}} = 5\text{ V} \pm 5\%$		± 2	± 5	$^{\circ}\text{C}$	$T_{\text{A}} = 85^{\circ}\text{C}$.
		± 2	± 3	$^{\circ}\text{C}$	$T_{\text{A}} = 0^{\circ}\text{C}$ to $+85^{\circ}\text{C}$.
		± 3	± 5	$^{\circ}\text{C}$	$T_{\text{A}} = -40^{\circ}\text{C}$ to $+120^{\circ}\text{C}$.
Resolution			10	Bits	$T_{\text{A}} = 0^{\circ}\text{C}$ to $+85^{\circ}\text{C}$.
Long-Term Drift		0.25		$^{\circ}\text{C}$	$T_{\text{A}} = -40^{\circ}\text{C}$ to $+120^{\circ}\text{C}$.
					Equivalent to 0.25°C .
					Drift over 10 years if part is operated at 55°C .

ADT7516/ADT7517/ADT7519

Parameter ¹	Min	Typ	Max	Unit	Conditions/Comments
THERMAL CHARACTERISTICS					
EXTERNAL TEMPERATURE SENSOR					
Accuracy @ $V_{DD} = 3.3\text{ V} \pm 10\%$			± 1.5	$^{\circ}\text{C}$	External transistor = 2N3906. $T_A = 85^{\circ}\text{C}$.
			± 3	$^{\circ}\text{C}$	$T_A = 0^{\circ}\text{C} + 85^{\circ}\text{C}$.
			± 5	$^{\circ}\text{C}$	$T_A = -40^{\circ}\text{C} \text{ to } +120^{\circ}\text{C}$.
Accuracy @ $V_{DD} = 5\text{ V} \pm 5\%$		± 2	± 3	$^{\circ}\text{C}$	$T_A = 0^{\circ}\text{C} + 85^{\circ}\text{C}$.
		± 3	± 5	$^{\circ}\text{C}$	$T_A = -40^{\circ}\text{C} \text{ to } +120^{\circ}\text{C}$.
Resolution			10	Bits	Equivalent to 0.25°C .
Output Source Current		180		μA	High Level.
		11		μA	Low Level.
Thermal Voltage Output					
8-Bit DAC Output					
Resolution	1			$^{\circ}\text{C}$	
Scale Factor		8.97		$\text{mV}/^{\circ}\text{C}$	0 V to V_{REF} output. $T_A = -40^{\circ}\text{C} \text{ to } +120^{\circ}\text{C}$.
		17.58		$\text{mV}/^{\circ}\text{C}$	0 V to $2 V_{REF}$ output. $T_A = -40^{\circ}\text{C} \text{ to } +120^{\circ}\text{C}$.
10-Bit DAC Output					
Resolution	0.25			$^{\circ}\text{C}$	
Scale Factor		2.2		$\text{mV}/^{\circ}\text{C}$	0 V to V_{REF} output. $T_A = -40^{\circ}\text{C} \text{ to } +120^{\circ}\text{C}$.
		4.39		$\text{mV}/^{\circ}\text{C}$	0 V to $2 V_{REF}$ output. $T_A = -40^{\circ}\text{C} \text{ to } +120^{\circ}\text{C}$.
CONVERSION TIMES					
Slow ADC					
V_{DD}/AIN		11.4		ms	Averaging (16 samples) on.
		712		μs	Averaging off.
Internal Temperature		11.4		ms	Averaging (16 samples) on.
		712		μs	Averaging off.
External Temperature		24.22		ms	Averaging (16 samples) on.
		1.51		ms	Averaging off.
Fast ADC					
V_{DD}/AIN		712		μs	Averaging (16 samples) on.
		44.5		μs	Averaging off.
Internal Temperature		2.14		ms	Averaging (16 samples) on.
		134		μs	Averaging off.
External Temperature		14.25		ms	Averaging (16 samples) on.
		890		μs	Averaging off.
ROUND ROBIN UPDATE RATE⁵					
Slow ADC @ 25°C					
Averaging On		79.8		ms	Time to complete one measurement cycle through all channels. AIN1 and AIN2 are selected on Pins 7 and 8.
Averaging Off		4.99		ms	AIN1 and AIN2 are selected on Pins 7 and 8.
Averaging On		94.76		ms	D+ and D- are selected on Pins 7 and 8.
Averaging Off		9.26		ms	D+ and D- are selected on Pins 7 and 8.
Fast ADC @ 25°C					
Averaging On		6.41		ms	AIN1 and AIN2 are selected on Pins 7 and 8.
Averaging Off		400.84		μs	AIN1 and AIN2 are selected on Pins 7 and 8.
Averaging On		21.77		ms	D+ and D- are selected on Pins 7 and 8.
Averaging Off		3.07		ms	D+ and D- are selected on Pins 7 and 8.
DAC EXTERNAL REFERENCE INPUT					
V_{REF} Input Range	1		V_{DD}	V	Buffered reference.
V_{REF} Input Impedance		>10		M Ω	Buffered reference and power-down mode.
Reference Feedthrough		-90		dB	Frequency = 10 kHz.
Channel-to-Channel Isolation		-75		dB	Frequency = 10 kHz.

Parameter ¹	Min	Typ	Max	Unit	Conditions/Comments
ON-CHIP REFERENCE					
Reference Voltage		2.28		V	
Temperature Coefficient ⁴		80		ppm/°C	
OUTPUT CHARACTERISTICS					
Output Voltage ⁶	0.001		V _{DD} – 0.1	V	This is a measure of the minimum and maximum drive capability of the output amplifier.
DC Output Impedance		0.5		Ω	
Short Circuit Current		25		mA	V _{DD} = 5 V.
		16		mA	V _{DD} = 3 V.
Power-Up Time		2.5		μs	Coming out of power-down mode. V _{DD} = 5 V.
		5		μs	Coming out of power-down mode. V _{DD} = 3.3 V.
DIGITAL INPUTS					
Input Current			±1	μA	V _{IN} = 0 V to V _{DD} .
V _{IL} , Input Low Voltage			0.8	V	
V _{IH} , Input High Voltage	1.89			V	
Pin Capacitance		3	10	pF	All digital inputs.
SCL, SDA Glitch Rejection			50	ns	Input filtering suppresses noise spikes of less than 50 ns.
$\overline{\text{LDAC}}$ Pulse Width	20			ns	Edge triggered input.
DIGITAL OUTPUT					
Digital High Voltage, V _{OH}	2.4			V	I _{SOURCE} = I _{SINK} = 200 μA.
Output Low Voltage, V _{OL}			0.4	V	I _{OL} = 3 mA.
Output High Current, I _{OH}			1	mA	V _{OH} = 5 V.
Output Capacitance, C _{OUT}			50	pF	
INT/ $\overline{\text{INT}}$ Output Saturation Voltage			0.8	V	I _{OUT} = 4 mA.
I²C TIMING CHARACTERISTICS^{7, 8}					
Serial Clock Period, t ₁	2.5			μs	Fast Mode I ² C. See Figure 2.
Data In Setup Time to SCL High, t ₂	50			ns	
Data Out Stable after SCL Low, t ₃	0			ns	See Figure 2.
SDA Low Setup Time to SCL Low (Start Condition), t ₄	50			ns	See Figure 2.
SDA High Hold Time after SCL High (Stop Condition), t ₅	50			ns	See Figure 2.
SDA and SCL Fall Time, t ₆			90	ns	See Figure 2.
SPI TIMING CHARACTERISTICS⁹					
$\overline{\text{CS}}$ to SCLK Setup Time, t ₁	0			ns	See Figure 3.
SCLK High Pulse Width, t ₂	50			ns	See Figure 3.
SCLK Low Pulse Width, t ₃	50			ns	See Figure 3.
Data Access Time after SCLK Falling Edge, t ₄ , ¹⁰			35	ns	
Data Setup Time Prior to SCLK Rising Edge, t ₅	20			ns	See Figure 3.
Data Hold Time after SCLK Rising Edge, t ₆	0			ns	See Figure 3.
$\overline{\text{CS}}$ to SCLK Hold Time, t ₇	0			μs	See Figure 3.
$\overline{\text{CS}}$ to DOUT High Impedance, t ₈			40	ns	See Figure 3.

ADT7516/ADT7517/ADT7519

Parameter ¹	Min	Typ	Max	Unit	Conditions/Comments
POWER REQUIREMENTS					
V _{DD}	2.7		5.5	V	
V _{DD} Settling Time			50	ms	V _{DD} settles to within 10% of its final voltage level.
I _{DD} (Normal Mode) ¹¹			3	mA	V _{DD} = 3.3 V, V _{IH} = V _{DD} , and V _{IL} = GND.
		2.2	3	mA	V _{DD} = 5 V, V _{IH} = V _{DD} , and V _{IL} = GND.
I _{DD} (Power-Down Mode)			10	μA	V _{DD} = 3.3 V, V _{IH} = V _{DD} , and V _{IL} = GND.
			10	μA	V _{DD} = 5 V, V _{IH} = V _{DD} , and V _{IL} = GND.
Power Dissipation			10	mW	V _{DD} = 3.3 V. Normal mode.
			33	μW	V _{DD} = 3.3 V. Shutdown mode.

¹ See the Terminology section.

² DC specifications are tested with the outputs unloaded.

³ Linearity is tested using a reduced code range: ADT7516 (Code 115 to 4095); ADT7517 (Code 28 to 1023); ADT7519 (Code 8 to 255).

⁴ Guaranteed by design and characterization, not production tested.

⁵ Round robin is the continuous sequential measurement of the following channels: V_{DD}, internal temperature, external temperature (AIN1, AIN2), AIN3, and AIN4.

⁶ For the amplifier output to reach its minimum voltage, the offset error must be negative. For the amplifier output to reach its maximum voltage (V_{REF} = V_{DD}), the offset plus gain error must be positive.

⁷ The SDA and SCL timing is measured with the input filters turned on to meet the fast-mode I²C specification. Switching off the input filters improves the transfer rate but has a negative effect on the EMC behavior of the part.

⁸ Guaranteed by design, not production tested.

⁹ All input signals are specified with tr = tf = 5 ns (10% to 90% of V_{DD}), and timed from a voltage level of 1.6 V.

¹⁰ Measured with the load circuit shown in Figure 4.

¹¹ The I_{DD} specification is valid for all DAC codes and full-scale analog input voltages. Interface inactive. All DACs and ADCs active. Load currents excluded.

DAC AC CHARACTERISTICS

Table 2. V_{DD} = 2.7 V to 5.5 V, R_L = 4.7 kΩ to GND; C_L = 200 pF to GND; 4.7 kΩ to V_{DD}; all specifications T_{MIN} to T_{MAX}, unless otherwise noted.

Parameter ^{1,2}	Min	Typ ³	Max	Unit	Conditions/Comments
Output Voltage Settling Time					V _{REF} = V _{DD} = 5 V.
ADT7519		6	8	μs	1/4 scale to 3/4 scale change (40h to C0h).
ADT7517		7	9	μs	1/4 scale to 3/4 scale change (100h to 300h).
ADT7516		8	10	μs	1/4 scale to 3/4 scale change (400h to C00h).
Slew Rate		0.7		V/μs	
Major-Code Change Glitch Energy		12		nV-s	1 LSB change around major carry.
Digital Feedthrough		0.5		nV-s	
Digital Crosstalk		1		nV-s	
Analog Crosstalk		0.5		nV-s	
DAC-to-DAC Crosstalk		3		nV-s	
Multiplying Bandwidth		200		kHz	V _{REF} = 2 V ±0.1 V p-p.
Total Harmonic Distortion		-70		dB	V _{REF} = 2.5 V ±0.1 V p-p. Frequency = 10 kHz.

¹ See Terminology section.

² Guaranteed by design and characterization, not production tested.

³ @ 25°C.

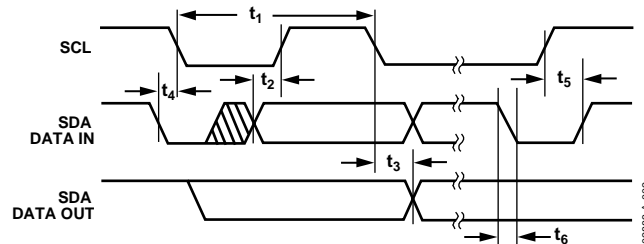

Figure 2. I²C Bus Timing Diagram

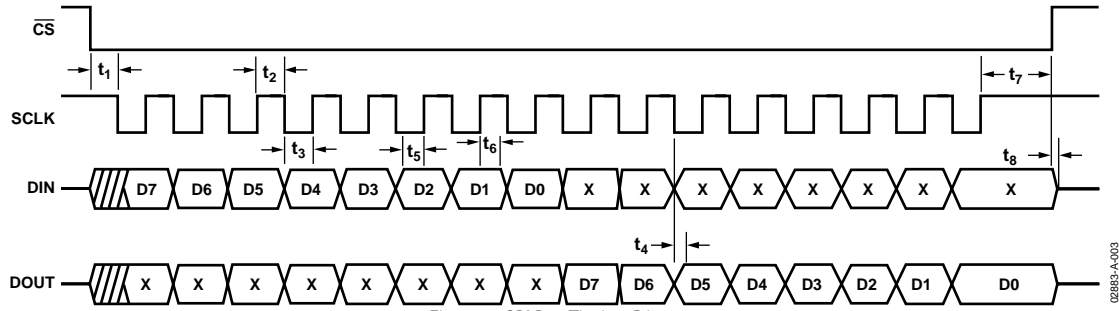

Figure 3. SPI Bus Timing Diagram

022883-A-003

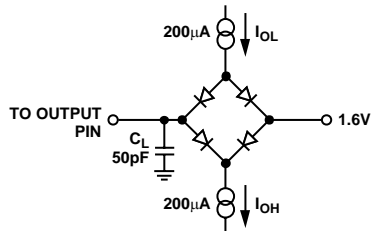

Figure 4. Load Circuit for Access Time and Bus Relinquish Time

022883-A-004

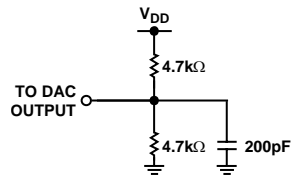

Figure 5. Load Circuit for DAC Outputs

022883-A-005

ADT7516/ADT7517/ADT7519

FUNCTIONAL BLOCK DIAGRAM

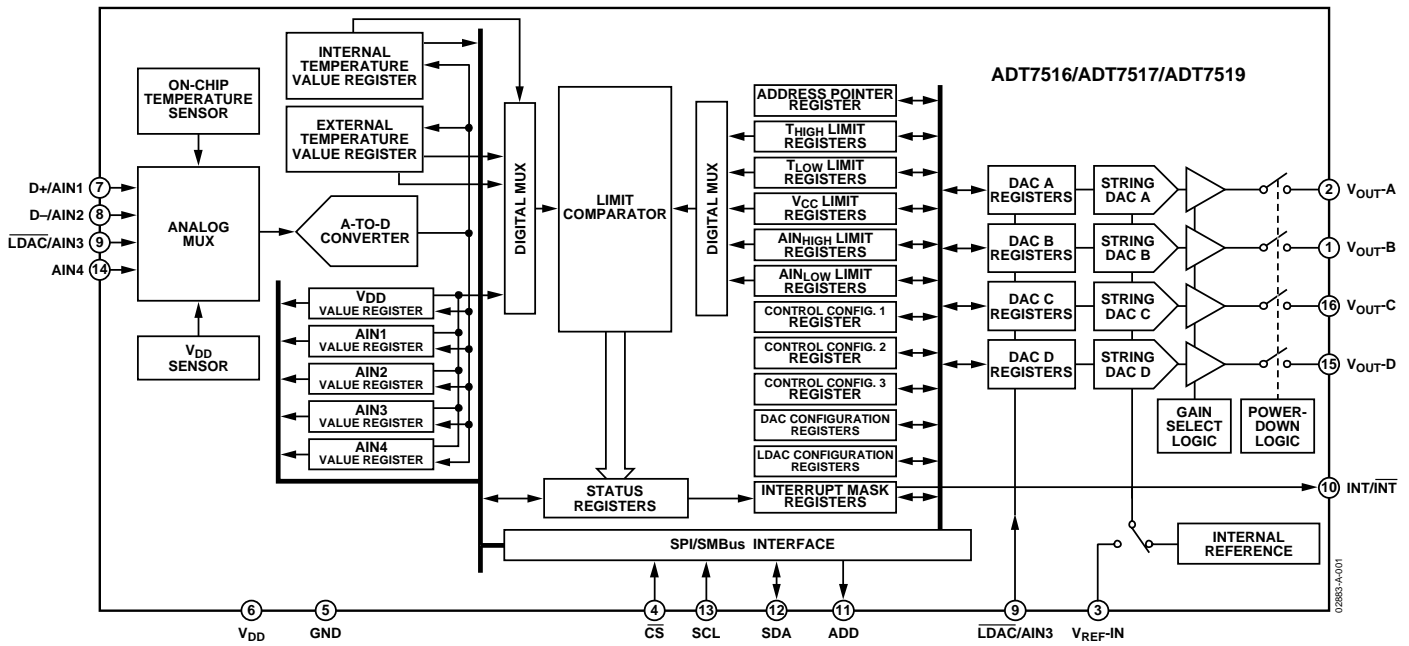

Figure 6.

ABSOLUTE MAXIMUM RATINGS

Table 3.

Parameter	Rating
V _{DD} to GND	-0.3 V to +7 V
Analog Input Voltage to GND	-0.3 V to V _{DD} + 0.3 V
Digital Input Voltage to GND	-0.3 V to V _{DD} + 0.3 V
Digital Output Voltage to GND	-0.3 V to V _{DD} + 0.3 V
Reference Input Voltage to GND	-0.3 V to V _{DD} + 0.3 V
Operating Temperature Range	-40°C to +120°C
Storage Temperature Range	-65°C to +150°C
Junction Temperature	150°C
16-Lead QSOP Package	
Power Dissipation ¹	(T _J max - T _A)/θ _{JA}
Thermal Impedance ²	
θ _{JA} Junction-to-Ambient	105.44°C/W
θ _{JC} Junction-to-Case	38.8°C/W
IR Reflow Soldering	
Peak Temperature	220°C (0°C/5°C)
Time at Peak Temperature	10 sec to 20 sec
Ramp-Up Rate	2°C/sec to 3°C/sec
Ramp-Down Rate	-6°C/sec

Table 4. I²C Address Selection

ADD Pin	I ² C Address
Low	1001 000
Float	1001 010
High	1001 011

Stresses above those listed under Absolute Maximum Ratings may cause permanent damage to the device. This is a stress rating only; functional operation of the device at these or any other conditions above those indicated in the operational section of this specification is not implied. Exposure to absolute maximum rating conditions for extended periods may affect device reliability.

¹ Values relate to package being used on a 4-layer board.

² Junction-to-case resistance is applicable to components featuring a preferential flow direction, e.g., components mounted on a heat sink. Junction-to-ambient resistance is more useful for air cooled PCB-mounted components.

ESD CAUTION

ESD (electrostatic discharge) sensitive device. Electrostatic charges as high as 4000 V readily accumulate on the human body and test equipment and can discharge without detection. Although this product features proprietary ESD protection circuitry, permanent damage may occur on devices subjected to high energy electrostatic discharges. Therefore, proper ESD precautions are recommended to avoid performance degradation or loss of functionality.



ADT7516/ADT7517/ADT7519

PIN CONFIGURATION AND FUNCTIONAL DESCRIPTIONS

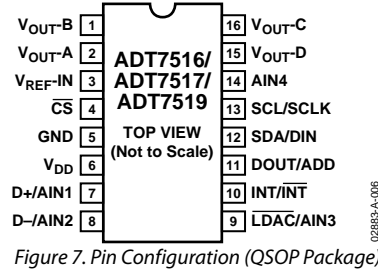

Figure 7. Pin Configuration (QSOP Package)

Table 5. Pin Function Descriptions

Pin No.	Mnemonic	Description
1	V _{OUT-B}	Buffered Analog Output Voltage from DAC B. The output amplifier has rail-to-rail operation.
2	V _{OUT-A}	Buffered Analog Output Voltage from DAC A. The output amplifier has rail-to-rail operation.
3	V _{REF-IN}	Reference Input Pin for All Four DACs. This input is buffered and has an input range from 1 V to V _{DD} .
4	\overline{CS}	SPI Active Low Control Input. This is the frame synchronization signal for the input data. When \overline{CS} goes low, it enables the input register, and data is transferred in on the rising edges and out on the falling edges of the subsequent serial clocks. It is recommended that this pin be tied high to V _{DD} when operating the serial interface in I ² C mode. -
5	GND	Ground Reference Point for All Circuitry on the Part. Analog and digital ground.
6	V _{DD}	Positive Supply Voltage, 2.7 V to 5.5 V. The supply should be decoupled to ground.
7	D+/AIN1	D+. Positive Connection to External Temperature Sensor. AIN1. Analog Input. Single-ended analog input channel. Input range is 0 V to 2.28 V or 0 V to V _{DD} .
8	D-/AIN2	D-. Negative Connection to External Temperature Sensor. AIN2. Analog Input. Single-ended analog input channel. Input range is 0 V to 2.28 V or 0 V to V _{DD} .
9	\overline{LDAC} /AIN3	\overline{LDAC} . Active Low Control Input. Transfers the contents of the input registers to their respective DAC registers. A falling edge on this pin forces any or all DAC registers to be updated if the input registers have new data. A minimum pulse width of 20 ns must be applied to the \overline{LDAC} pin to ensure proper loading of a DAC register. This allows simultaneous update of all DAC outputs. Bit C3 of the Control Configuration 3 register enables the \overline{LDAC} pin. Default is with the \overline{LDAC} pin controlling the loading of the DAC registers. AIN3. Analog Input. Single-ended analog input channel. Input range is 0 V to 2.28 V or 0 V to V _{DD} .
10	INT/ \overline{INT}	Over Limit Interrupt. The output polarity of this pin can be set to give an active low or active high interrupt when temperature, V _{DD} , or AIN limits are exceeded. The default is active low. Open-drain output—needs a pull-up resistor.
11	DOUT/ADD	SPI Serial Data Output. Logic output. Data is clocked out of any register at this pin. Data is clocked out on the falling edge of SCLK. Open-drain output—needs a pull-up resistor. ADD. I ² C Serial Bus Address Selection Pin. Logic input. A low on this pin gives the address 1001 000; leaving it floating gives the address 1001 010; and setting it high gives the address 1001 011. The I ² C address set up by the ADD pin is not latched by the device until after this address has been sent twice. On the eighth SCL cycle of the second valid communication, the serial bus address is latched in. Any subsequent changes on this pin will have no effect on the I ² C serial bus address.
12	SDA/DIN	SDA. I ² C Serial Data Input/Output. I ² C serial data to be loaded into the part's registers and read from these registers is provided on this pin. Open-drain configuration—needs a pull-up resistor. DIN. SPI Serial Data Input. Serial data to be loaded into the part's registers is provided on this pin. Data is clocked into a register on the rising edge of SCLK. Open-drain configuration—needs a pull-up resistor.
13	SCL/SCLK	Serial Clock Input. This is the clock input for the serial port. The serial clock is used to clock data out of any register of the ADT7516/ADT7517/ADT7519 and also to clock data into any register that can be written to. Open-drain configuration—needs a pull-up resistor.
14	AIN4	Analog Input. Single-ended analog input channel. Input range is 0 V to 2.28 V or 0 V to V _{DD} .
15	V _{OUT-D}	Buffered Analog Output Voltage from DAC D. The output amplifier has rail-to-rail operation.
16	V _{OUT-C}	Buffered Analog Output Voltage from DAC C. The output amplifier has rail-to-rail operation.

TERMINOLOGY

Relative Accuracy

Relative accuracy or integral nonlinearity (INL) is a measure of the maximum deviation, in LSBs, from a straight line passing through the endpoints of the transfer function. Typical INL versus code plots can be seen in Figure 10, Figure 11, and Figure 12.

Differential Nonlinearity

Differential nonlinearity (DNL) is the difference between the measured change and the ideal 1 LSB change between any two adjacent codes. A specified differential nonlinearity of ± 0.9 LSB maximum ensures monotonicity. Typical DAC DNL versus code plots can be seen in Figure 13, Figure 14, and Figure 15.

Total Unadjusted Error (TUE)

Total unadjusted error is a comprehensive specification that includes the sum of the relative accuracy error, gain error, and offset error under a specified set of conditions.

Offset Error

This is a measure of the offset error of the DAC and the output amplifier (See Figure 8 and Figure 9). It can be negative or positive, and it is expressed in mV.

Offset Error Match

This is the difference in offset error between any two channels.

Gain Error

This is a measure of the span error of the DAC. It is the deviation in slope of the actual DAC transfer characteristic from the ideal expressed as a percentage of the full-scale range.

Gain Error Match

This is the difference in gain error between any two channels.

Offset Error Drift

This is a measure of the change in offset error with changes in temperature. It is expressed in (ppm of full-scale range)/ $^{\circ}\text{C}$.

Gain Error Drift

This is a measure of the change in gain error with changes in temperature. It is expressed in (ppm of full-scale range)/ $^{\circ}\text{C}$.

Long Term Temperature Drift

This is a measure of the change in temperature error with the passage of time. It is expressed in $^{\circ}\text{C}$. The concept of long-term stability has been used for many years to describe the amount an IC's parameter would shift during its lifetime. This is a concept that has typically been applied to both voltage references and monolithic temperature sensors. Unfortunately, integrated circuits cannot be evaluated at room temperature (25°C) for 10 years or so to determine this shift. Manufacturers perform accelerated lifetime testing of integrated circuits by operating ICs at elevated temperatures (between 125°C and 150°C) over a shorter period (typically between 500 and 1000

hours). As a result, the lifetime of an integrated circuit is significantly accelerated due to the increase in rates of reaction within the semiconductor material.

DC Power Supply Rejection Ratio (PSRR)

This indicates how the output of the DAC is affected by changes in the supply voltage. PSRR is the ratio of the change in V_{OUT} to a change in V_{DD} for full-scale output of the DAC. It is measured in dB. V_{REF} is held at 2 V and V_{DD} is varied $\pm 10\%$.

DC Crosstalk

This is the dc change in the output level of one DAC in response to a change in the output of another DAC. It is measured with a full-scale output change on one DAC while monitoring another DAC. It is expressed in μV .

Reference Feedthrough

This is the ratio of the amplitude of the signal at the DAC output to the reference input when the DAC output is not being updated (i.e., LDAC is high). It is expressed in dB.

Channel-to-Channel Isolation

This is the ratio of the amplitude of the signal at the output of one DAC to a sine wave on the reference input of another DAC. It is measured in dB.

Major-Code Transition Glitch Energy

Major-code transition glitch energy is the energy of the impulse injected into the analog output when the code in the DAC register changes state. It is normally specified as the area of the glitch in nV-s and is measured when the digital code is changed by 1 LSB at the major carry transition (011...11 to 100...00 or 100...00 to 011...11).

Digital Feedthrough

Digital feedthrough is a measure of the impulse injected into the analog output of a DAC from the digital input pins of the device but is measured when the DAC is not being written to. It is specified in nV-s and is measured with a full-scale change on the digital input pins, i.e., from all 0s to all 1s or vice versa.

Digital Crosstalk

This is the glitch impulse transferred to the output of one DAC at midscale in response to a full-scale code change (all 0s to all 1s and vice versa) in the input register of another DAC. It is measured in standalone mode and is expressed in nV-s.

Analog Crosstalk

This is the glitch impulse transferred to the output of one DAC due to a change in the output of another DAC. It is measured by loading one of the input registers with a full-scale code change (all 0s to all 1s and vice versa) while keeping $\overline{\text{LDAC}}$ high. Then pulse $\overline{\text{LDAC}}$ low and monitor the output of the DAC whose digital code was not changed. The area of the glitch is expressed in nV-s.

DAC-to-DAC Crosstalk

This is the glitch impulse transferred to the output of one DAC due to a digital code change and subsequent output change of another DAC. This includes both digital and analog crosstalk. It is measured by loading one of the DACs with a full-scale code change (all 0s to all 1s and vice versa) with \overline{LDAC} low and monitoring the output of another DAC. The energy of the glitch is expressed in nV-s.

Multiplying Bandwidth

The amplifiers within the DAC have a finite bandwidth. The multiplying bandwidth is a measure of this. A sine wave on the reference (with full-scale code loaded to the DAC) appears on the output. The multiplying bandwidth is the frequency at which the output amplitude falls to 3 dB below the input.

Total Harmonic Distortion

This is the difference between an ideal sine wave and its attenuated version using the DAC. The sine wave is used as the reference for the DAC, and the THD is a measure of the harmonics present on the DAC output, expressed in dB.

Round Robin

This term is used to describe the ADT7516/ADT7517/ADT7519 cycling through the available measurement channels in sequence, taking a measurement on each channel.

DAC Output Settling Time

This is the time required, following a prescribed data change, for the output of a DAC to reach and remain within ± 0.5 LSB of the final value. A typical prescribed change is from 1/4 scale to 3/4 scale.

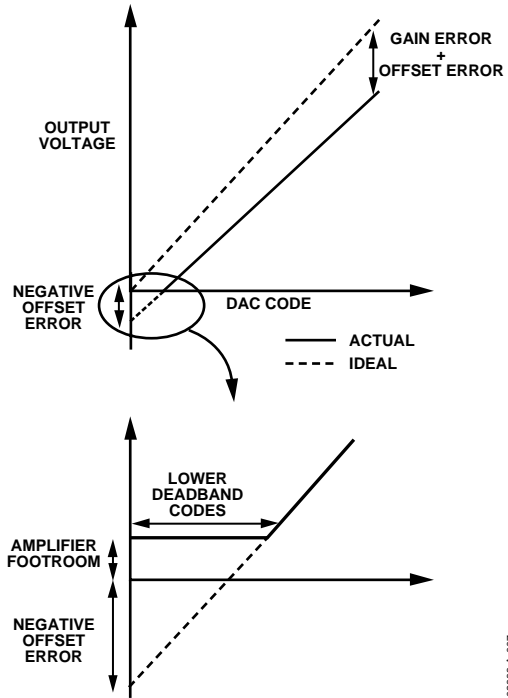

Figure 8. DAC Transfer Function with Negative Offset

02885-A-007

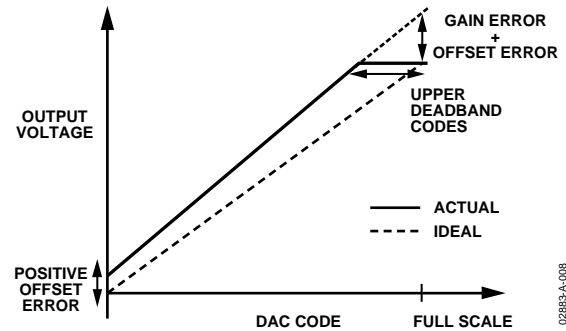

Figure 9. DAC Transfer Function with Positive Offset ($V_{REF} = V_{DD}$)

02883-A-008

TYPICAL PERFORMANCE CHARACTERISTICS

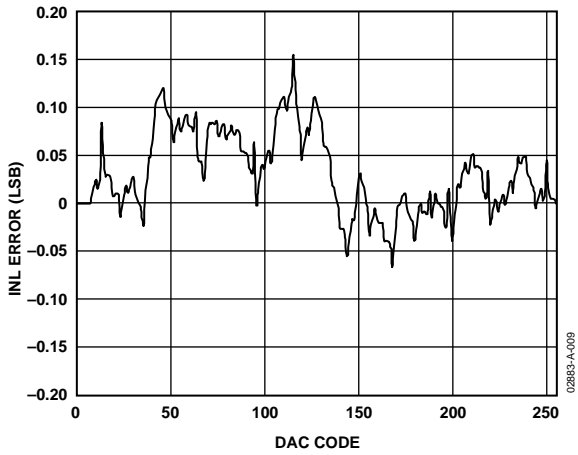

Figure 10. ADT7519 Typical DAC INL Plot

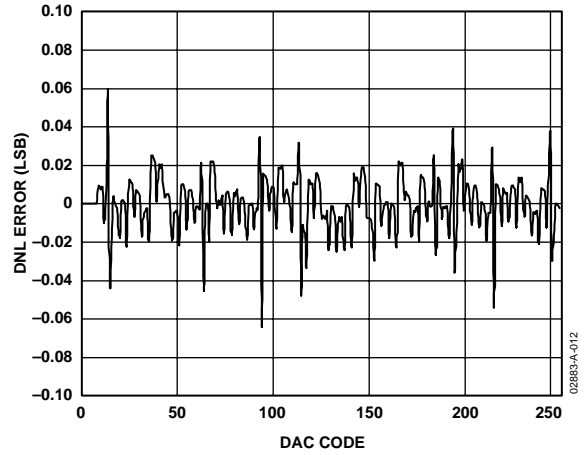

Figure 13. ADT7519 Typical DAC DNL Plot

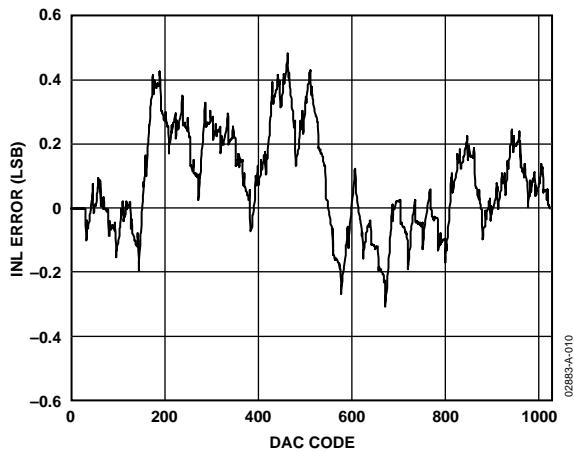

Figure 11. ADT7517 Typical DAC INL Plot

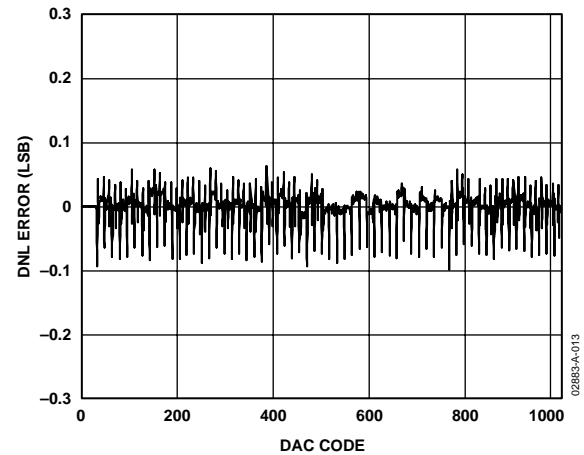

Figure 14. ADT7517 Typical DAC DNL Plot

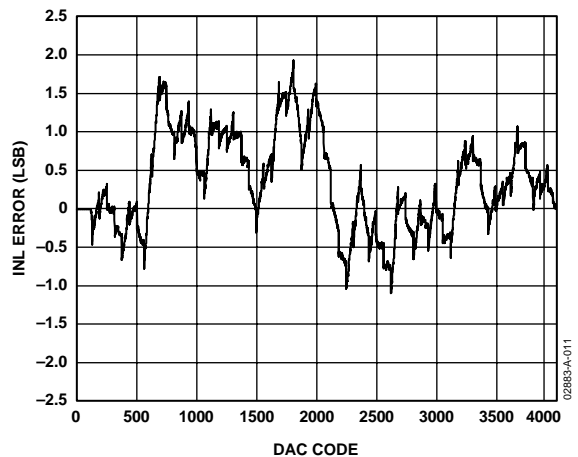

Figure 12. ADT7516 Typical DAC INL Plot

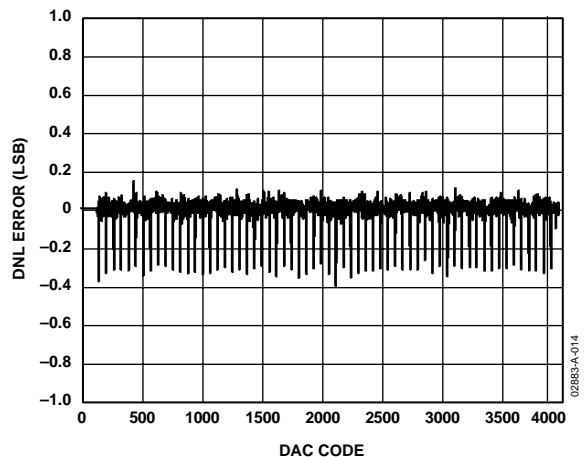

Figure 15. ADT7516 Typical DAC DNL Plot

ADT7516/ADT7517/ADT7519

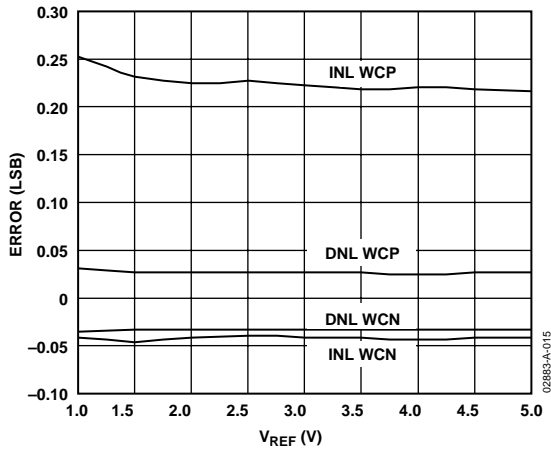

Figure 16. ADT7519 DAC INL and DNL Error vs. V_{REF}

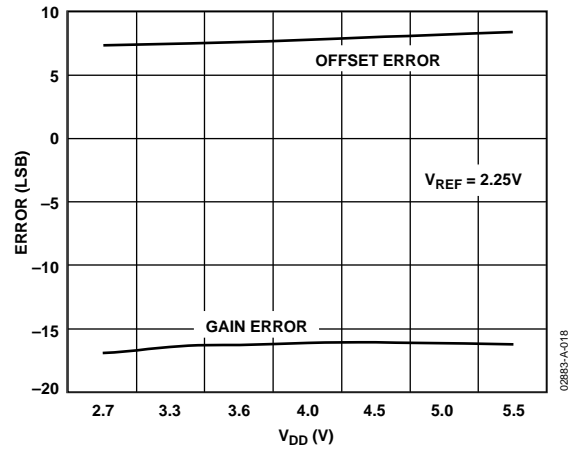

Figure 19. DAC Offset Error and Gain Error vs. V_{DD}

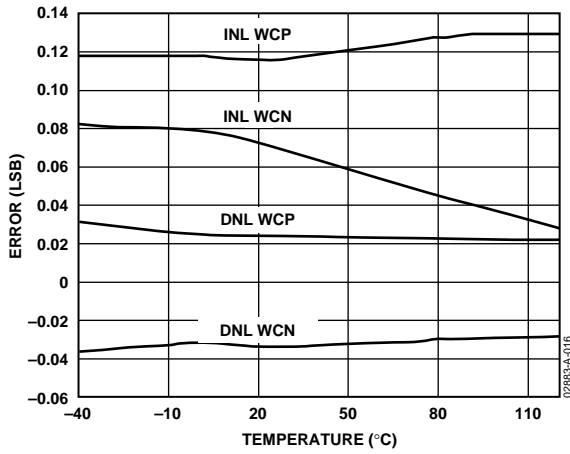

Figure 17. ADT7519 DAC INL Error and DNL Error vs. Temperature

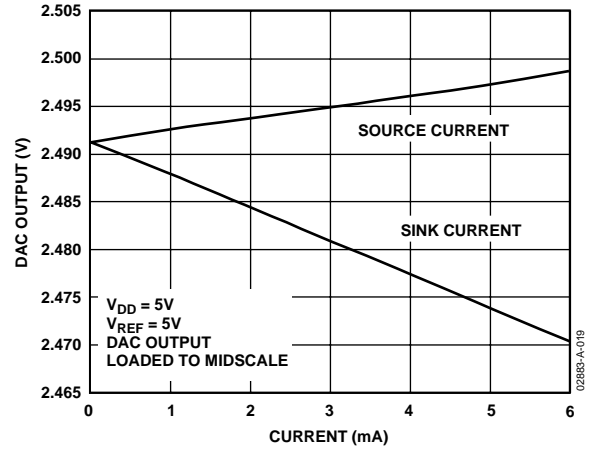

Figure 20. DAC V_{OUT} Source and Sink Current Capability

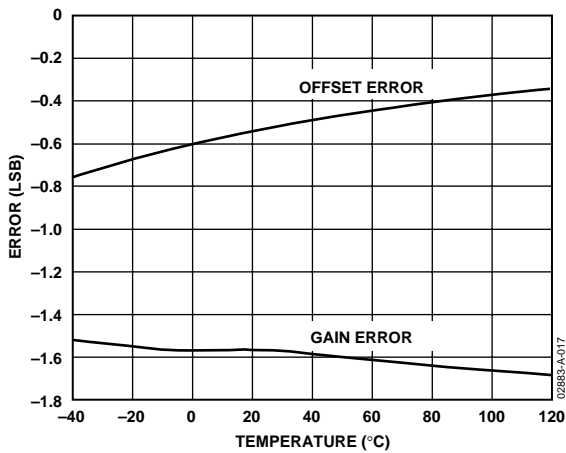

Figure 18. DAC Offset Error and Gain Error vs. Temperature

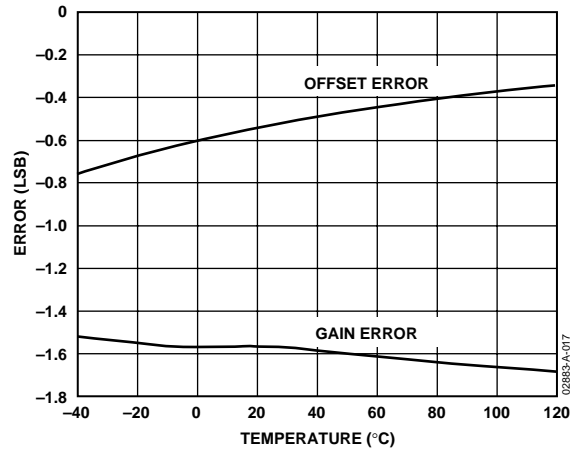

Figure 21. Supply Current vs. DAC Code

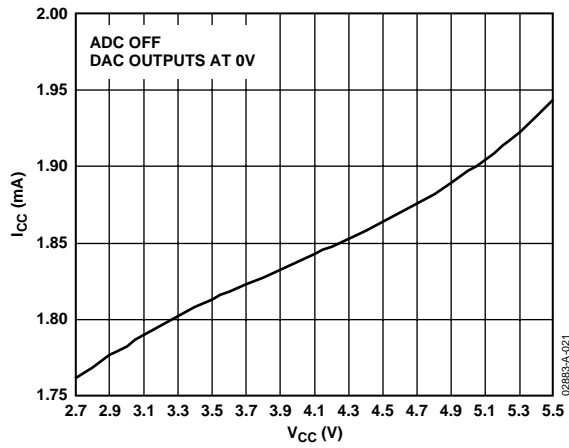

Figure 22. Supply Current vs. Supply Voltage @ 25°C

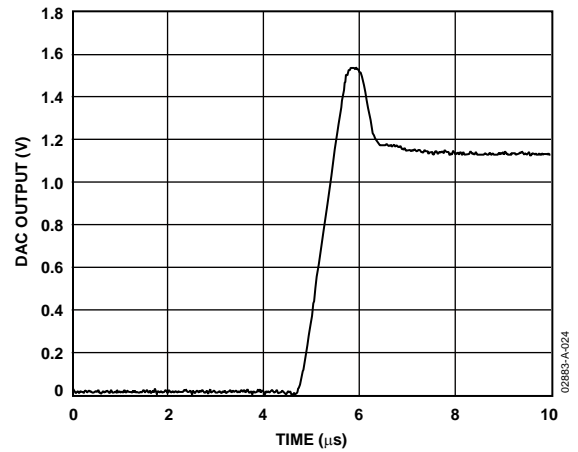

Figure 25. Exiting Power-Down to Midscale

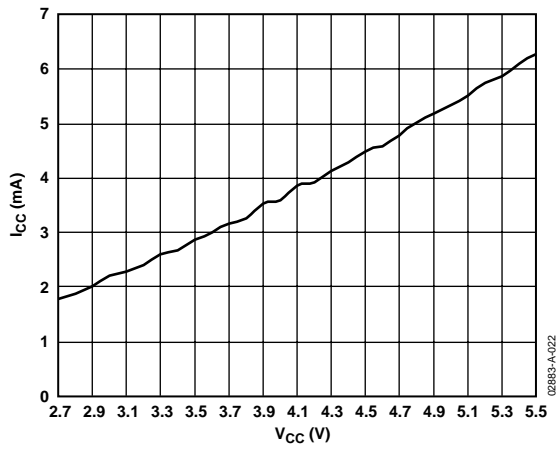

Figure 23. Power-Down Current vs. Supply Voltage @ 25°C

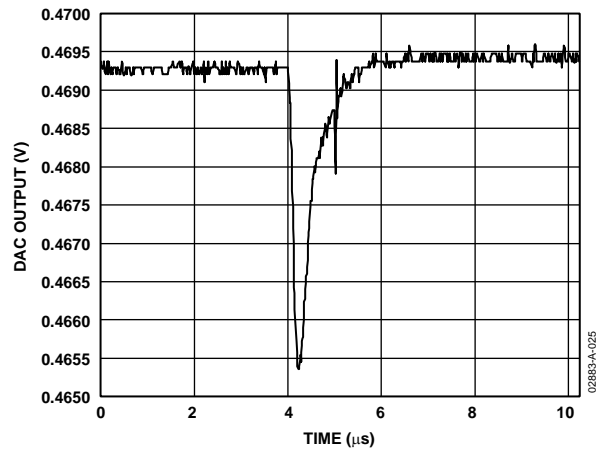

Figure 26. ADT7516 DAC Major Code Transition Glitch Energy; 011...11 to 100...00

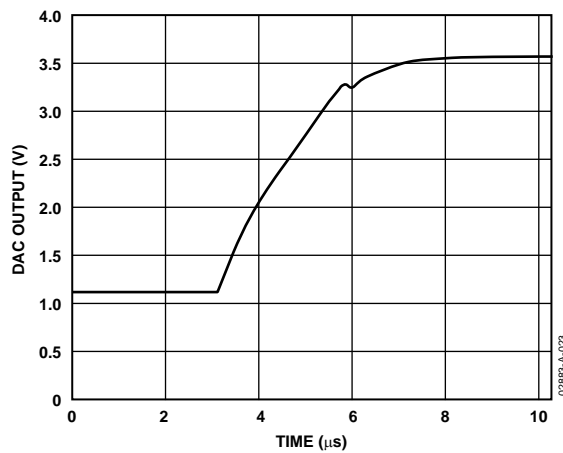

Figure 24. DAC Half-Scale Settling (1/4 to 3/4 Scale Code Change)

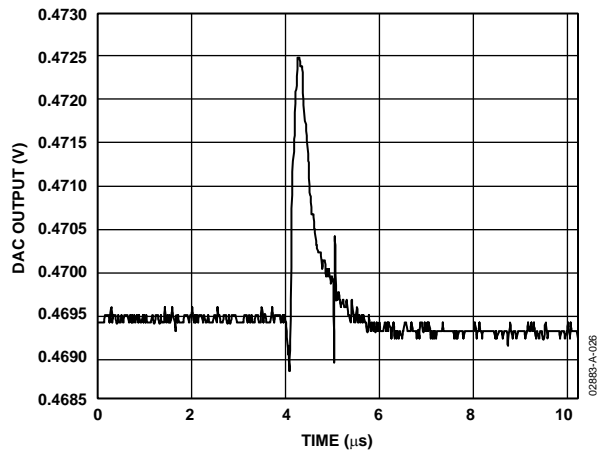

Figure 27. ADT7516 DAC Major Code Transition Glitch Energy; 100...00 to 011...11

ADT7516/ADT7517/ADT7519

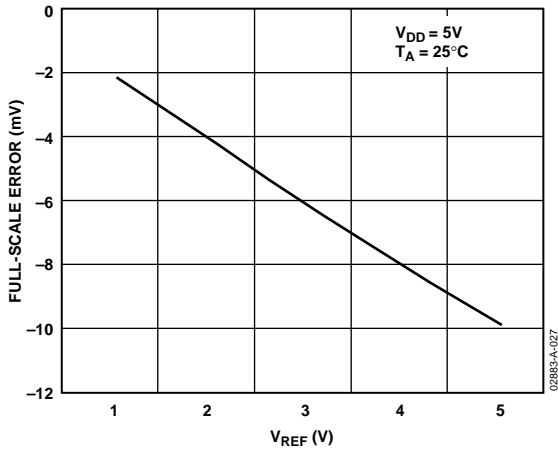

Figure 28. DAC Full-Scale Error vs. V_{REF}

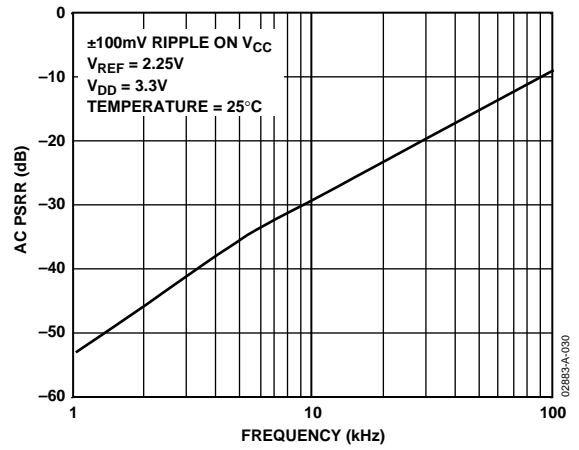

Figure 31. PSRR vs. Supply Ripple Frequency

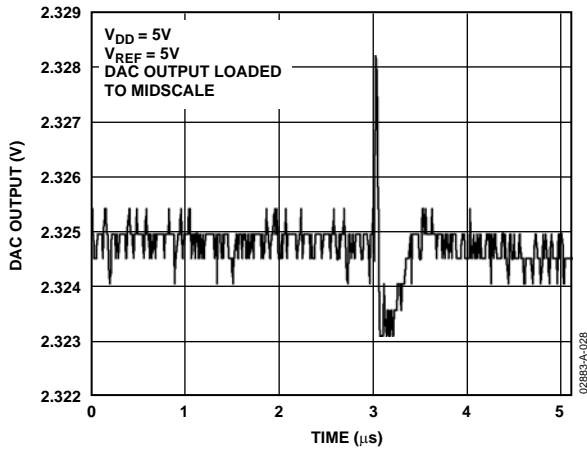

Figure 29. DAC-to-DAC Crosstalk

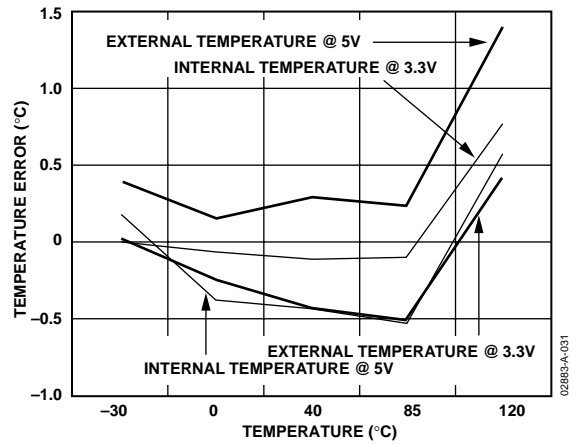

Figure 32. Internal Temperature Error @ 3.3V and 5V

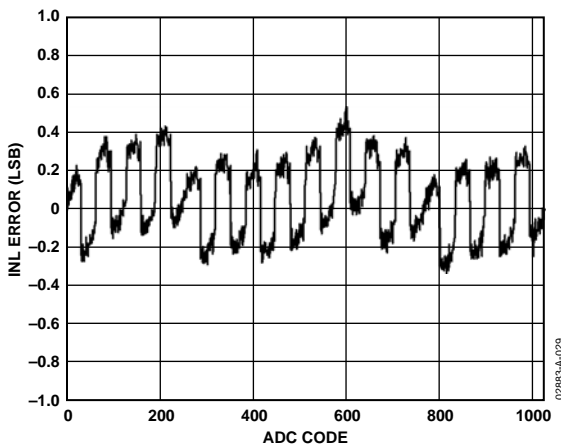

Figure 30. ADC INL with Ref = V_{DD} (3.3V)

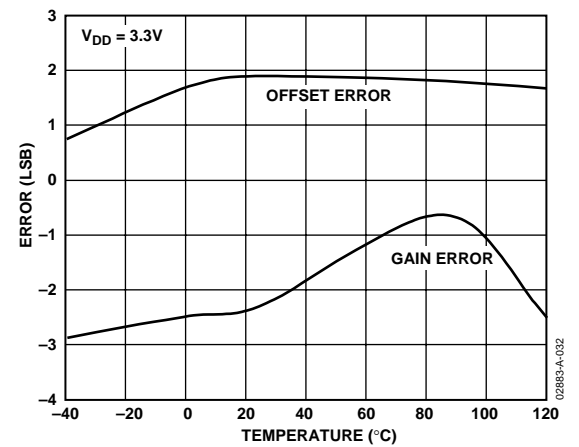

Figure 33. ADC Offset Error and Gain Error vs. Temperature

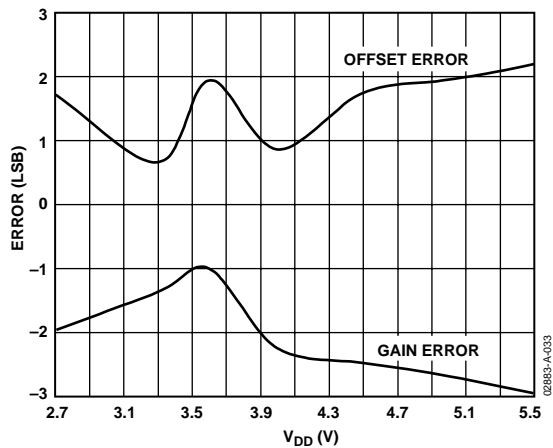

Figure 34. ADC Offset Error and Gain Error vs. V_{DD}

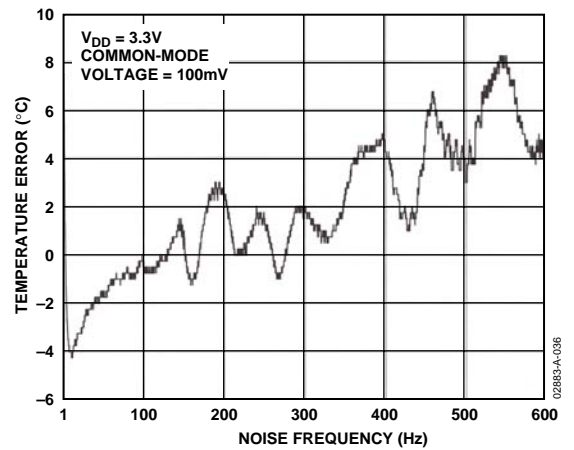

Figure 37. External Temperature Error vs. Common-Mode Noise Frequency

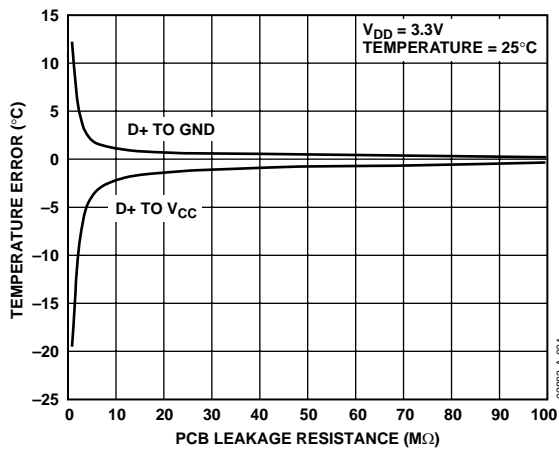

Figure 35. External Temperature Error vs. PCB Leakage Resistance

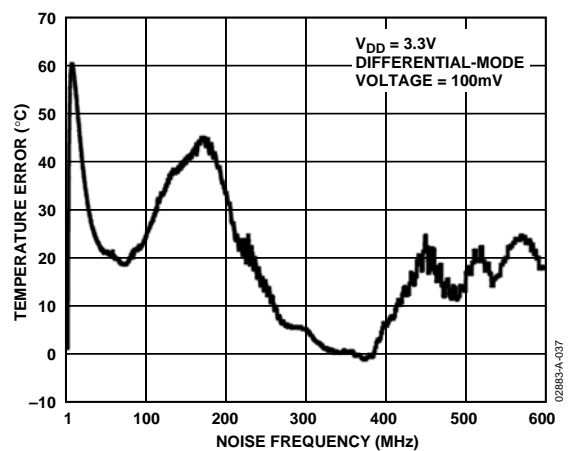

Figure 38. External Temperature Error vs. Differential-Mode Noise Frequency

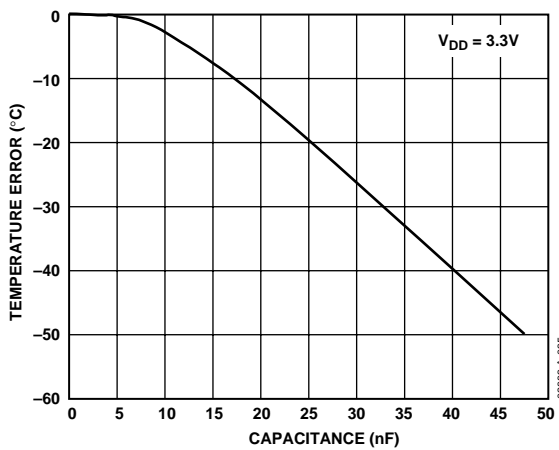

Figure 36. External Temperature Error vs. Capacitance between D+ and D-

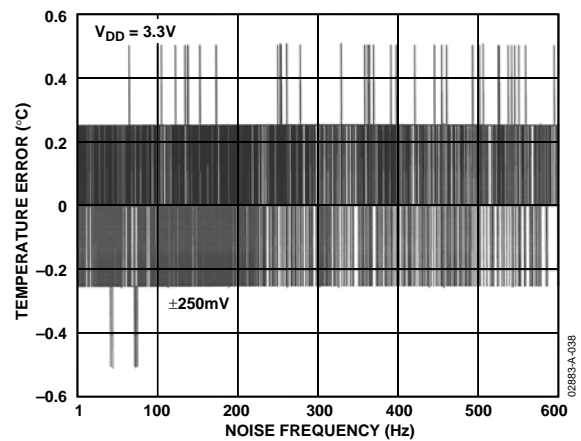

Figure 39. Internal Temperature Error vs. Power Supply Noise Frequency

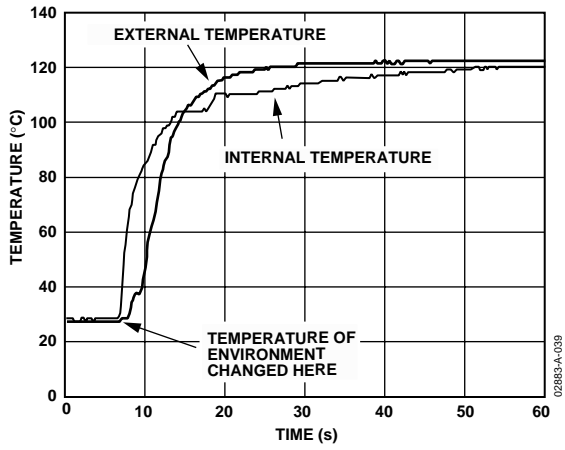

Figure 40. Temperature Sensor Response to Thermal Shock

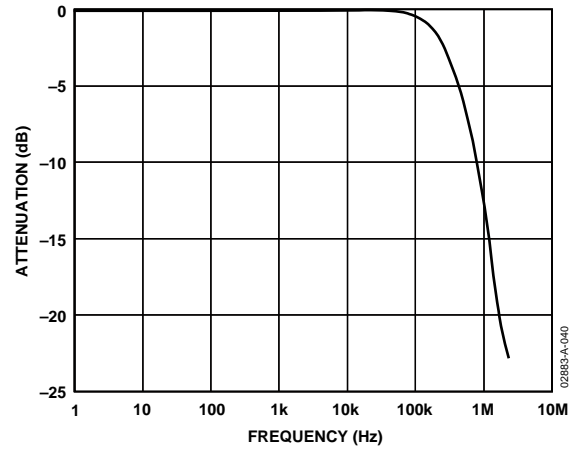

Figure 41. DAC Multiplying Bandwidth (Small Signal Frequency Response)

THEORY OF OPERATION

Directly after the power-up calibration routine, the ADT7516/ADT7517/ADT7519 go into idle mode. In this mode, the devices are not performing any measurements and are fully powered up. All four DAC outputs are at 0 V.

To begin monitoring, write to the Control Configuration 1 register (Address 18h) and set Bit C0 = 1. The ADT7516/ADT7517/ADT7519 go into their power-up default measurement mode, which is round robin. The devices proceed to take measurements on the V_{DD} channel, internal temperature sensor channel, external temperature sensor channel, or AIN1 and AIN2, AIN3, and finally AIN4. Once they finish taking measurements on the AIN4 channel, the devices immediately loop back to start taking measurements on the V_{DD} channel and repeats the same cycle as before. This loop continues until the monitoring is stopped by resetting Bit C0 of the Control Configuration 1 register to 0.

It is also possible to continue monitoring as well as switching to single-channel mode by writing to the Control Configuration 2 register (Address 19h) and setting Bit C4 = 1. Further explanation of the single-channel and round robin measurement modes is given in later sections. All measurement channels have averaging enabled on them on power-up. Averaging forces the devices to take an average of 16 readings before giving a final measured result. To disable averaging and consequently decrease the conversion time by a factor of 16, set Bit C5 = 1 in the Control Configuration 2 register.

There are four single-ended analog input channels on the ADT7516/ADT7517/ADT7519: AIN1 to AIN4. AIN1 and AIN2 are multiplexed with the external temperature sensor terminals D+ and D-. Bits C1 and C2 of the Control Configuration 1 register (Address 18h) are used to select between AIN1/AIN2 and the external temperature sensor. The input range on the analog input channels is dependent on whether the ADC reference used is the internal V_{REF} or V_{DD} . To meet linearity specifications, it is recommended that the maximum V_{DD} value is 5 V. Bit C4 of the Control Configuration 3 register is used to select between the internal reference or V_{DD} as the analog inputs' ADC reference.

Controlling the DAC outputs can be done by writing to the DACs' MSB and LSB registers (Addresses 10h to 17h). The power-up default setting is to have a low going pulse on the LDAC pin (Pin 9) controlling the updating of the DAC outputs from the DAC registers. Alternatively, one can configure the updating of the DAC outputs to be controlled by means other than the LDAC pin by setting Bit C3 = 1 of the Control Configuration 3 register (Address 1Ah). The DAC Configuration register (Address 1Bh) and the LDAC Configuration register (Address 1Ch) can now be used to control the DAC updating. These two registers also control the output range of

the DACs and selecting between the internal or external reference. DAC A and DAC B outputs can be configured to give a voltage output proportional to the temperature of the internal and external temperature sensors, respectively.

The dual serial interface defaults to the I²C protocol on power-up. To select and lock in the SPI protocol, follow the selection process as described in the Serial Interface Selection section. The I²C protocol cannot be locked in, while the SPI protocol is automatically locked in on selection. The interface can be switched back to be I²C on selection when the device is powered off and on. When using I²C, the CS pin should be tied to either V_{DD} or GND.

There are a number of different operating modes on the ADT7516/ADT7517/ADT7519 devices and all of them can be controlled by the configuration registers. These features consist of enabling and disabling interrupts, polarity of the INT/ \overline{INT} pin, enabling and disabling the averaging on the measurement channels SMBus timeout and software reset.

POWER-UP CALIBRATION

It is recommended that no communication to the part be initiated until approximately 5 ms after V_{DD} has settled to within 10% of its final value. It is generally accepted that most systems take a maximum of 50 ms to power up. Power-up time is directly related to the amount of decoupling on the voltage supply line.

During the 5 ms after V_{DD} has settled, the part is performing a calibration routine. Any communication to the device during calibration will interrupt this routine, and could cause erroneous temperature measurements. If it is not possible to have V_{DD} at its nominal value by the time 50 ms has elapsed or if communication to the device has started prior to V_{DD} settling, it is recommended that a measurement be taken on the V_{DD} channel before a temperature measurement is taken. The V_{DD} measurement is used to calibrate out any temperature measurement error due to different supply voltage values.

CONVERSION SPEED

The internal oscillator circuit used by the ADC has the capability to output two different clock frequencies. This means that the ADC is capable of running at two different speeds when doing a conversion on a measurement channel. Thus, the time taken to perform a conversion on a channel can be reduced by setting Bit C0 of the Control Configuration 3 register (Address 1Ah). This increases the ADC clock speed from 1.4 kHz to 22 kHz. At the higher clock speed, the analog filters on the D+ and D- input pins (external temperature sensor) are switched off. This is why the power-up default setting is to have the ADC working at the slow speed. The typical times for fast and slow ADC speeds are given in the specifications.

ADT7516/ADT7517/ADT7519

The ADT7516/ADT7517/ADT7519 power up with averaging on. This means every channel is measured 16 times and internally averaged to reduce noise. The conversion time can also be sped up by turning off the averaging. This is done by setting Bit C5 of the Control Configuration 2 register (Address 19h) to 1.

FUNCTION DESCRIPTION—VOLTAGE OUTPUT Digital-to-Analog Converters

The ADT7516/ADT7517/ADT7519 have four resistor string DACs fabricated on a CMOS process with resolutions of 12, 10, and 8 bits, respectively. They contain four output buffer amplifiers and are written to via I²C serial interface or SPI serial interface. See the Serial Interface section for more information.

The ADT7516/ADT7517/ADT7519 operate from a single supply of 2.7 V to 5.5 V, and the output buffer amplifiers provide rail-to-rail output swing with a slew rate of 0.7 V/μs. All four DACs share a common reference input, V_{REF-IN}. The reference input is buffered to draw virtually no current from the reference source because it offers the source a high impedance input. The devices have a power-down mode in which all DACs may be turned off completely with a high impedance output.

Each DAC output will not be updated until it receives the LDAC command. Therefore, while the DAC registers would have been written to with a new value, this value will not be represented by a voltage output until the DACs have received the LDAC command. Reading back from any DAC register prior to issuing an LDAC command will result in the digital value that corresponds to the DAC output voltage. Thus, the digital value written to the DAC register cannot be read back until after the LDAC command has been initiated. This LDAC command can be given by either pulling the $\overline{\text{LDAC}}$ pin low (falling edge loads DACs), setting up Bits D4 and D5 of the DAC configuration register (Address 1Bh), or using the LDAC register (Address 1Ch).

When using the $\overline{\text{LDAC}}$ pin to control the DAC register loading, the low going pulse width should be 20 ns minimum. The $\overline{\text{LDAC}}$ pin has to go high and low again before the DAC registers can be reloaded.

Digital-to-Analog Section

The architecture of one DAC channel consists of a resistor string DAC followed by an output buffer amplifier. The voltage at the V_{REF-IN} pin or the on-chip reference of 2.28 V provides the reference voltage for the corresponding DAC. Figure 42 shows a block diagram of the DAC architecture. Since the input coding to the DAC is straight binary, the ideal output voltage is given by

$$V_{OUT} = \frac{V_{REF} \times D}{2^N}$$

where:

D = decimal equivalent of the binary code that is loaded to the DAC register:

0 to 255 for ADT7519 (8 bits)

0 to 1023 for ADT7517 (10 bits)

0 to 4095 for ADT7516 (12 bits)

N = DAC resolution

Resistor String

The resistor string section is shown in Figure 43. It is simply a string of resistors, each of approximately 603 Ω. The digital code loaded to the DAC register determines at which node on the string the voltage is tapped off to be fed into the output amplifier. The voltage is tapped off by closing one of the switches connecting the string to the amplifier. Because it is a string of resistors, it is guaranteed monotonic.

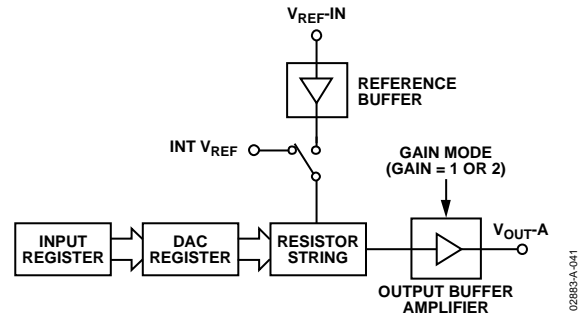

Figure 42. Single DAC Channel Architecture

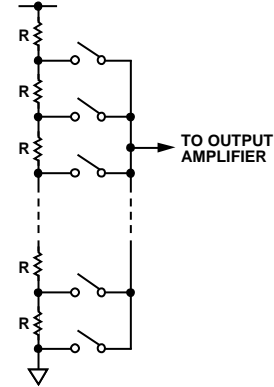

Figure 43. Resistor String

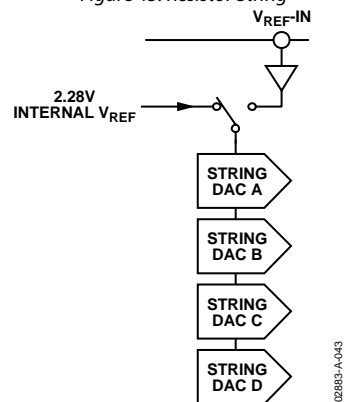

Figure 44. DAC Reference Buffer Circuit

DAC Reference Inputs

There is an input reference pin for the DACs. This reference input is buffered (see Figure 44).

The advantage with the buffered input is the high impedance it presents to the voltage source driving it. The user can have an external reference voltage as low as 1 V and as high as V_{DD} . The restriction of 1 V is due to the footroom of the reference buffer.

The LDAC configuration register controls the option to select between internal and external voltage references. The default setting is for external reference selected.

Output Amplifier

The output buffer amplifier can generate output voltages to within 1 mV of either rail. Its actual range depends on the value of V_{REF} , gain, and offset error.

If a gain of 1 is selected (Bits 0 to 3 of the DAC configuration register = 0), the output range is 0.001 V to V_{REF} .

If a gain of 2 is selected (Bits 0 to 3 of the DAC configuration register = 1), the output range is 0.001 V to $2 V_{REF}$. Because of clamping, however, the maximum output is limited to $V_{DD} - 0.001 V$.

The output amplifier can drive a load of 4.7 k Ω to GND or V_{DD} , in parallel with 200 pF to GND or V_{DD} (see Figure 5). The source and sink capabilities of the output amplifier can be seen in the plot of Figure 20.

The slew rate is 0.7 V/ μ s with a half-scale settling time to ± 0.5 LSB (at 8 bits) of 6 μ s.

Thermal Voltage Output

The ADT7516/ADT7517/ADT7519 can output voltages that are proportional to temperature. DAC A output can be configured to represent the temperature of the internal sensor while DAC B output can be configured to represent the external temperature sensor. Bits C5 and C6 of the Control Configuration 3 register select the temperature proportional output voltage. Each time a temperature measurement is taken, the DAC output is updated. The output resolution for the ADT7519 is 8 bits with 1°C change corresponding to 1 LSB change. The output resolution for the ADT7516 and ADT7517 are capable of 10 bits with

0.25°C change corresponding to 1 LSB change. The default output resolution for the ADT7516 and ADT7517 is 8 bits. To increase this to 10 bits, set C1 = 1 in the Control Configuration 3 register. The default output range is 0 V to V_{REF} and this can be increased to 0 V to $2 V_{REF}$. Increasing the output voltage span to $2 V_{REF}$ can be done by setting D0 = 1 for DAC A (internal temperature sensor) and D1 = 1 for DAC B (external temperature sensor) in the DAC configuration register (Address 1Bh).

The output voltage is capable of tracking a maximum temperature range of -128°C to +127°C, but the default setting is -40°C to +127°C. If the output voltage range is 0 V to V_{REF-IN} ($V_{REF-IN} = 2.25 V$), then this corresponds to 0 V representing -40°C, and 1.48 V representing +127°C. This, of course, will give an upper deadband between 1.48 V and V_{REF} .

The internal and external analog temperature offset registers can be used to vary this upper deadband and, consequently, the temperature that 0 V corresponds to. Table 6 and Table 7 give examples of how this is done using a DAC output voltage span of V_{REF} and $2 V_{REF}$, respectively. Simply write in the temperature value, in twos complement format, at which 0 V is to start. For example, if using the DAC A output and 0 V to start at -40°C, program D8h into the internal analog temperature offset register (Address 21h). This is an 8-bit register and has a temperature offset resolution of only 1°C for all device models. Use the formulas following the tables to determine the value to program into the offset registers.

Table 6. Thermal Voltage Output (0 V to V_{REF})

O/P Voltage (V)	Default °C	Max °C	Sample °C
0	-40	-128	0
0.5	+17	-71	+56
1	+73	-15	+113
1.12	+87	-1	+127
1.47	+127	+39	UDB*
1.5	UDB*	+42	UDB*
2	UDB*	+99	UDB*
2.25	UDB*	+127	UDB*

* Upper deadband has been reached. DAC output is not capable of increasing. See Figure 9.

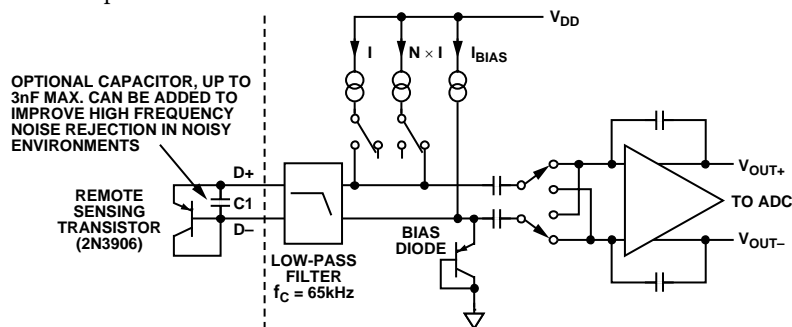

Figure 45. Signal Conditioning for External Diode Temperature Sensor

ADT7516/ADT7517/ADT7519

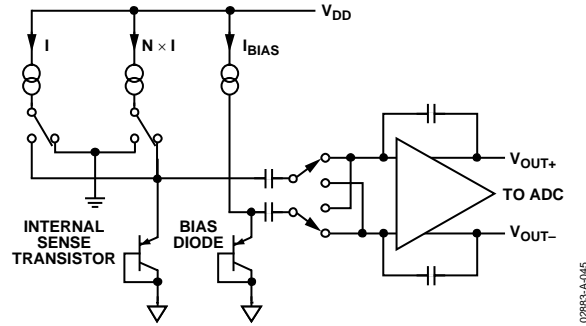

Figure 46. Top Level Structure of Internal Temperature Sensor

Table 7. Thermal Voltage Output (0 V to 2V_{REF})

O/P Voltage (V)	Default °C	Max °C	Sample °C
0	-40	-128	0
0.25	-26	-114	+14
0.5	+12	-100	+28
0.75	+3	-85	+43
1	+17	-71	+57
1.12	+23	-65	+63
1.47	+43	-45	+83
1.5	+45	-43	+85
2	+73	-15	+113
2.25	+88	0	+127
2.5	+102	+14	UDB*
2.75	+116	+28	UDB*
3	UDB*	+42	UDB*
3.25	UDB*	+56	UDB*
3.5	UDB*	+70	UDB*
3.75	UDB*	+85	UDB*
4	UDB*	+99	UDB*
4.25	UDB*	+113	UDB*
4.5	UDB*	+127	UDB*

The following equation is used to work out the various temperatures for the corresponding 8-bit DAC output:

$$8\text{-Bit Temp} = (\text{DAC O/P} \div 1\text{LSB}) + (0\text{ V Temp})$$

For example, if the output is 1.5 V, V_{REF-IN} = 2.25 V, 8-bit DAC has an LSB size = 2.25 V/256 = 8.79 × 10⁻³, and 0 V temp is at -128°C, then the resultant temperature is

$$(1.5 \div 8.79 \times 10^{-3}) + (-128) = +43^\circ\text{C}$$

The following equation is used to work out the various temperatures for the corresponding 10-bit DAC output:

$$10\text{-Bit Temp} = ((\text{DAC O/P} \div 1\text{LSB}) \times 0.25) + (0\text{ V Temp})$$

For example, if the output is 0.4991 V, V_{REF-IN} = 2.25 V, 10-bit DAC has an LSB size = 2.25 V/1024 = 2.197 × 10⁻³, and 0 V temp is at -40°C, then the resulting temperature is

$$(((0.4991 \div 2.197 \times 10^{-3}) \times 0.25) + (-40)) = +16.75^\circ\text{C}$$

Figure 47 shows a graph of the DAC output versus temperature for a V_{REF-IN} = 2.25 V.

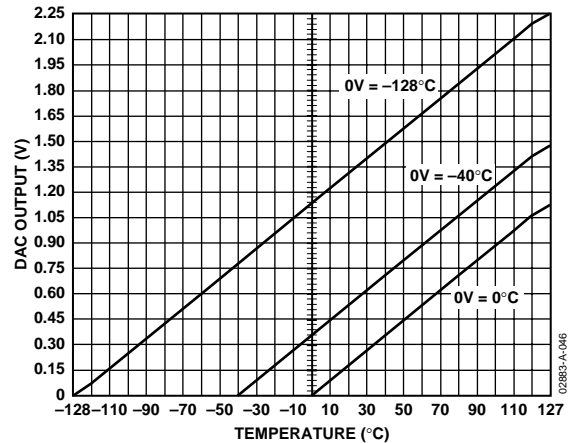

Figure 47. DAC Output vs. Temperature V_{REF-IN} = 2.25 V

Negative temperatures:

$$\text{Offset Register Code}(d) = (0\text{ V Temp}) + 128$$

where:

D7 of Offset Register Code is set to 1 for negative temperatures.

Example:

$$\text{Offset Register Code}(d) = (-40) + 128 = 88d = 58h$$

Since a negative temperature has been inserted into the equation, DB7 (MSB) of the offset register code is set to 1. Therefore 58h becomes D8h.

$$58h + \text{DB7}(1) = \text{D8h}$$

Positive temperatures:

$$\text{Offset Register Code}(d) = 0\text{ V Temp}$$

Example:

$$\text{Offset Register Code}(d) = 10d = 0Ah$$

FUNCTIONAL DESCRIPTION—ANALOG INPUTS

Single-Ended Inputs

The ADT7516/ADT7517/ADT7519 offer four single-ended analog input channels. The analog input range is from 0 V to 2.28 V, or 0 V to V_{DD} . To maintain the linearity specification, it is recommended that the maximum V_{DD} value be set at 5 V. Selection between the two input ranges is done by Bit C4 of the Control Configuration 3 register (Address 1Ah). Setting this bit to 0 sets up the analog input ADC reference to be sourced from the internal voltage reference of 2.28 V. Setting the bit to 1 sets up the ADC reference to be sourced from V_{DD} .

The ADC resolution is 10 bits and is mostly suitable for dc input signals. Bits C1:2 of the Control Configuration 1 register (Address 18h) are used to set up Pins 7 and 8 as AIN1 and AIN2. Figure 48 shows the overall view of the 4-channel analog input path.

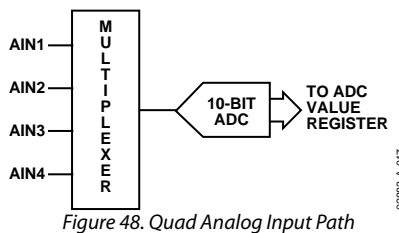

Figure 48. Quad Analog Input Path

Converter Operation

The analog input channels use a successive approximation ADC based on a capacitor DAC. Figure 49 and Figure 50 show simplified schematics of the ADC. Figure 49 shows the ADC during acquisition phase. SW2 is closed and SW1 is in Position A. The comparator is held in a balanced condition and the sampling capacitor acquires the signal on AIN.

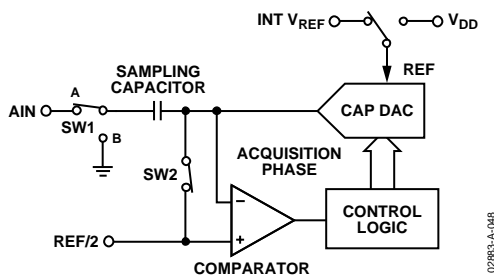

Figure 49. ADC Acquisition Phase

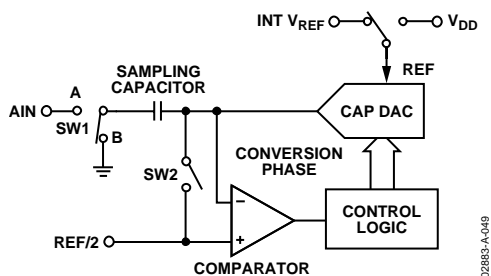

Figure 50. ADC Conversion Phase

When the ADC eventually goes into conversion phase (see Figure 50), SW2 opens and SW1 moves to position B, causing the comparator to become unbalanced. The control logic and the DAC are used to add and subtract fixed amounts of charge from the sampling capacitor to bring the comparator back into a balanced condition. When the comparator is rebalanced, the conversion is complete. The control logic generates the ADC output code. Figure 51 shows the ADC transfer function for the analog inputs.

ADC TRANSFER FUNCTION

The output coding of the ADT7516/ADT7517/ADT7519 analog inputs is straight binary. The designed code transitions occur midway between successive integer LSB values (i.e., 1/2 LSB, 3/2 LSB). The LSB is $V_{DD}/1024$ or internal $V_{REF}/1024$, internal $V_{REF} = 2.28$ V. The ideal transfer characteristic is shown in Figure 51.

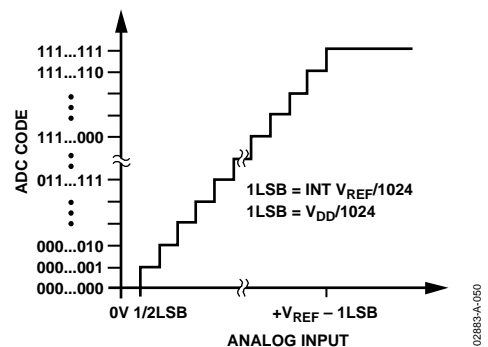

Figure 51. Single-Ended Transfer Function

To work out the voltage on any analog input channel, the following method can be used:

$$1 \text{ LSB} = \text{reference (v)}/1024$$

Convert value read back from AIN value register into decimal.

$$\text{AIN voltage} = \text{AIN value}(d) \times \text{LSB size}$$

d = decimal

Example:

Internal reference used. Therefore $V_{REF} = 2.28$ V.

AIN value = 512d

$$1 \text{ LSB size} = 2.28 \text{ V} / 1024 = 2.226 \times 10^{-3}$$

$$\text{AIN voltage} = 512 \times 2.226 \times 10^{-3} = 1.14 \text{ V}$$

Analog Input ESD Protection

Figure 52 shows the input structure on any of the analog input pins that provides ESD protection. The diode provides the main ESD protection for the analog inputs. Care must be taken that the analog input signal never drops below the GND rail by more than 200 mV. If this happens, the diode will become forward-biased and start conducting current into the substrate. The 4 pF capacitor is the typical pin capacitance and the resistor is a lumped component made up of the on resistance of the multiplexer switch.

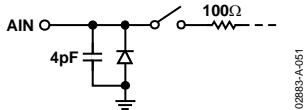

Figure 52. Equivalent Analog Input ESD Circuit

AIN Interrupts

The measured results from the AIN inputs are compared with the AIN V_{HIGH} (greater than comparison) and V_{LOW} (less than or equal to comparison) limits. An interrupt occurs if the AIN inputs exceed or equal the limit registers. These voltage limits are stored in on-chip registers. Note that the limit registers are 8 bits long while the AIN conversion result is 10 bits long. If the voltage limits are not masked out, then any out-of-limit comparisons generate flags that are stored in the Interrupt Status 1 register (Address = 00h) and one or more out-of-limit results will cause the INT/\overline{INT} output to pull either high or low depending on the output polarity setting. It is good design practice to mask out interrupts for channels that are of no concern to the application. Figure 53 shows the interrupt structure for the ADT7516/ ADT7517/ADT7519. It gives a block diagram representation of how the various measurement channels affect the INT/\overline{INT} pin.

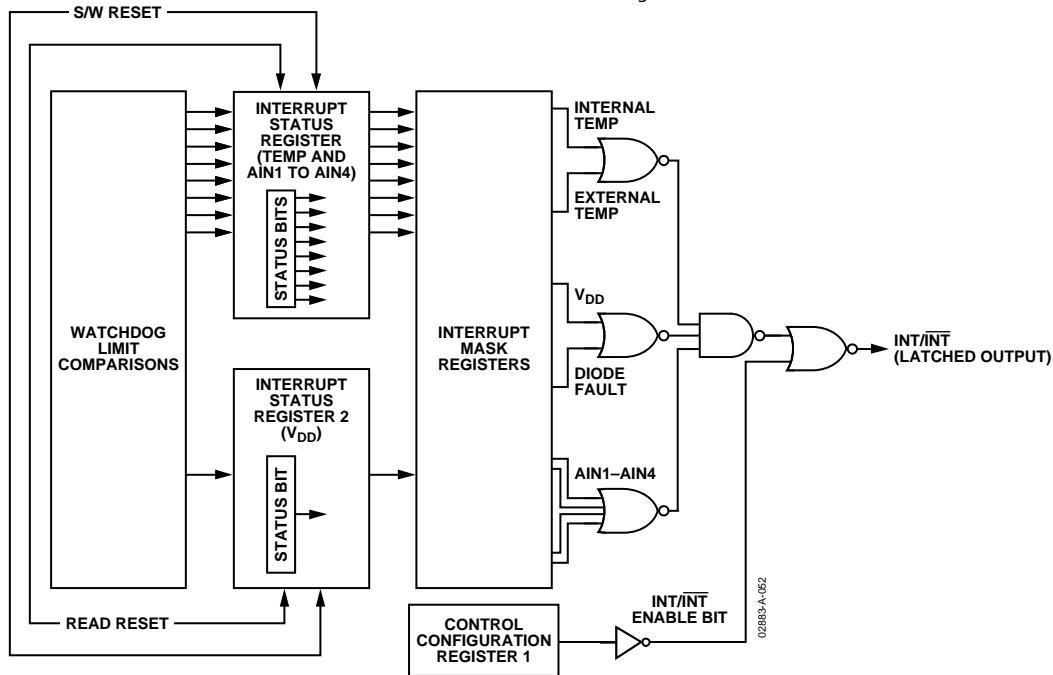

Figure 53. ADT7516/ADT7517/ADT7519 Interrupt Structure

* Upper deadband has been reached. DAC output is not capable of increasing. See Figure 9.

FUNCTIONAL DESCRIPTION—MEASUREMENT

Temperature Sensor

The ADT7516/ADT7517/ADT7519 contain an ADC with special input signal conditioning to enable operation with external and on-chip diode temperature sensors. When the ADT7516/ADT7517/ADT7519 is operating in single-channel mode, the ADC continually processes the measurement taken on one channel only. This channel is preselected by Bits C0:C2 in the Control Configuration 2 register (Address 19h). When in round robin mode, the analog input multiplexer sequentially selects the V_{DD} input channel, the on-chip temperature sensor to measure its internal temperature, either the external temperature sensor or AIN1 and AIN2, AIN3, and then AIN4. These signals are digitized by the ADC and the results are stored in the various value registers.

The measured results from the temperature sensors are compared with the internal and external T_{HIGH} , T_{LOW} limits. These temperature limits are stored in on-chip registers. If the temperature limits are not masked, any out-of-limit comparisons generate flags that are stored in the Interrupt Status 1 register. One or more out-of-limit results will cause the INT/INT output to pull either high or low depending on the output polarity setting.

Theoretically, the temperature measuring circuit can measure temperatures from -128°C to $+127^{\circ}\text{C}$ with a resolution of 0.25°C . However, temperatures outside T_A are outside the guaranteed operating temperature range of the device. Temperature measurement from -128°C to $+127^{\circ}\text{C}$ is possible using an external sensor.

Temperature measurement is initiated by three methods. The first method is applicable when the part is in single-channel measurement mode. The temperature is measured 16 times and internally averaged to reduce noise. In single-channel mode, the part is continuously monitoring the selected channel, i.e., as soon as one measurement is taken another one is started on the same channel. The total time to measure a temperature channel with the ADC operating at slow speed is typically 11.4 ms ($712\ \mu\text{s} \times 16$) for the internal temperature sensor and 24.22 ms ($1.51\ \text{ms} \times 16$) for the external temperature sensor. The new temperature value is stored in two 8-bit registers and is ready for reading by the I²C or SPI interface. The user has the option of disabling the averaging by setting Bit 5 in the Control Configuration 2 register (Address 19h). The ADT7516/ADT7517/ADT7519 default on power-up with averaging enabled.

The second method is applicable when the part is in round robin measurement mode. The part measures both the internal and external temperature sensors as it cycles through all possible measurement channels. The two temperature channels are measured each time the part runs a round robin sequence. In round robin mode, the part is continuously measuring all channels.

Temperature measurement is also initiated after every read or write to the part when the part is in either single-channel measurement mode or round robin measurement mode.

Once serial communication has started, any conversion in progress stops and the ADC resets. Conversion restarts immediately after the serial communication has finished. The temperature measurement proceeds normally as described above.

V_{DD} Monitoring

The ADT7516/ADT7517/ADT7519 also have the ability to monitor its own power supply. The part measures the voltage on its V_{DD} pin to a resolution of 10 bits. The resulting value is stored in two 8-bit registers; the two LSBs are stored in register address 03h and the eight MSBs are stored in register address 06h. This allows the option of doing just a 1-byte read if 10-bit resolution is not important. The measured result is compared with the V_{HIGH} and V_{LOW} limits. If the V_{DD} interrupt is not masked, any out-of-limit comparison generates a flag in the Interrupt Status 2 register and one or more out-of-limit results will cause the INT/INT output to pull either high or low, depending on the output polarity setting.

Measuring the voltage on the V_{DD} pin is regarded as monitoring a channel along with the internal, external, and AIN channels. The user can select the V_{DD} channel for single-channel measurement by setting Bit C4 = 1 and setting Bits C0:C2 to all 0s in the Control Configuration 2 register.

When measuring the V_{DD} value, the reference for the ADC is sourced from the internal reference. Table 8 shows the data format. As the maximum V_{DD} voltage measurable is 7 V, internal scaling is performed on the V_{DD} voltage to match the 2.28 V internal reference value. Below is an example of how the transfer function works.

$$\begin{aligned}
 V_{DD} &= 5\ \text{V} \\
 \text{ADC Reference} &= 2.28\ \text{V} \\
 1\ \text{LSB} &= \text{ADC Reference}/2^{10} \\
 &= 2.28/1024 \\
 &= 2.226\ \text{mV} \\
 \text{Scale Factor} &= \text{Full-scale } V_{CC}/\text{ADC Reference} \\
 &= 7/2.28 \\
 &= 3.07 \\
 \text{Conversion Result} &= V_{DD}/(\text{Scale Factor} \times \text{LSB size}) \\
 &= 5/(3.07 \times 2.226\ \text{mV}) \\
 &= 2\ \text{DCh}
 \end{aligned}$$

ADT7516/ADT7517/ADT7519

Table 8. V_{DD} Data Format (V_{REF} = 2.28 V)

V _{DD} Value (V)	Digital Output	
	Binary	Hex
2.7	01 1000 1011	18B
3	01 1011 0111	1B7
3.5	10 0000 0000	200
4	10 0100 1001	249
4.5	10 1001 0010	292
5	10 1101 1100	2DC
5.5	11 0010 0101	325
6	11 0110 1110	36E
6.5	11 1011 0111	3B7
7	11 1111 1111	3FF

On-Chip Reference

The ADT7516/ADT7517/ADT7519 have an on-chip 1.2 V band gap reference, which is gained up by a switched capacitor amplifier to give an output of 2.28 V. The amplifier is powered up for the duration of the device monitoring phase and is powered down once monitoring is disabled. This saves on current consumption. The internal reference is used as the reference for the ADC. The ADC is used for measuring V_{DD}, internal temperature sensor, external temperature sensor, and AIN inputs. The internal reference is always used when measuring V_{DD}, and the internal and external temperature sensors. The external reference is the default power-up reference for the DACs.

Round Robin Measurement

On power-up, the ADT7516/ADT7517/ADT7519 go into round robin mode but monitoring is disabled. Setting Bit C0 of the Configuration Register 1 to 1 enables conversions. It sequences through all the available channels, taking a measurement from each in the following order: V_{DD}, internal temperature sensor, external temperature sensor/(AIN1 and AIN2), AIN3, and AIN4. Pin 7 and Pin 8 can be configured to be either external temperature sensor pins or standalone analog input pins. Once conversion is completed on the AIN4 channel, the device loops around for another measurement cycle. This method of taking a measurement on all the channels in one cycle is called round robin. Setting Bit C4 of Control Configuration 2 (Address 19h) disables the round robin mode and in turn sets up the single-channel mode. The single-channel mode is where only one channel, e.g., internal temperature sensor, is measured in each conversion cycle.

The time taken to monitor all channels will normally not be of interest, since the most recently measured value can be read at any time. For applications where the round robin time is important, typical times at 25°C are given in the specifications.

Single-Channel Measurement

Setting C4 of the Control Configuration 2 register enables the single-channel mode and allows the ADT7516/ADT7517/ADT7519 to focus on one channel only. A channel is selected by writing to Bits C0:C2 in the Control Configuration 2 register.

For example, to select the V_{DD} channel for monitoring, write to the Control Configuration 2 register and set C4 to 1 (if not done so already), then write all 0s to Bits C0:C2. All subsequent conversions will be done on the V_{DD} channel only. To change the channel selection to the internal temperature channel, write to the Control Configuration 2 register and set C0 = 1. When measuring in single-channel mode, conversions on the channel selected occur directly after each other. Any communication to the ADT7516/ADT7517/ADT7519 stops the conversions, but they are restarted once the read or write operation is completed.

Temperature Measurement Method

Internal Temperature Measurement

The ADT7516/ADT7517/ADT7519 contain an on-chip band gap temperature sensor whose output is digitized by the on-chip ADC. The temperature data is stored in the Internal Temperature Value register. Because both positive and negative temperatures can be measured, the temperature data is stored in twos complement format, as shown in Table 9. The thermal characteristics of the measurement sensor could change and, therefore, an offset is added to the measured value to enable the transfer function to match the thermal characteristics. This offset is added before the temperature data is stored. The offset value used is stored in the internal temperature offset register.

External Temperature Measurement

The ADT7516/ADT7517/ADT7519 can measure the temperature of one external diode sensor or diode-connected transistor.

The forward voltage of a diode or diode-connected transistor, operated at a constant current, exhibits a negative temperature coefficient of about -2 mV/°C. Unfortunately, because the absolute value of V_{BE} varies from device to device, and individual calibration is required to null this out, the technique is unsuitable for mass production.

The technique used in the ADT7516/ADT7517/ADT7519 is to measure the change in V_{BE} when the device is operated at two different currents. This is given by

$$\Delta V_{BE} = KT / q \times \ln(N)$$

where:

K is Boltzmann's constant.

q is the charge on the carrier.

T is the absolute temperature in kelvins.

N is the ratio of the two currents.

Figure 45 shows the input signal conditioning used to measure the output of an external temperature sensor. This figure shows the external sensor as a substrate transistor, provided for temperature monitoring on some microprocessors, but it could equally well be a discrete transistor.

If a discrete transistor is used, the collector will not be grounded, and should be linked to the base. If a PNP transistor is used, the base is connected to the D- input and the emitter to the D+ input. If an NPN transistor is used, the emitter is connected to the D- input and the base to the D+ input.

A 2N3906 is recommended as the external transistor.

To prevent ground noise interfering with the measurement, the more negative terminal of the sensor is not referenced to ground, but is biased above ground by an internal diode at the D- input. As the sensor is operating in a noisy environment, C1 is provided as a noise filter. See the Layout Considerations section for more information on C1.

To measure ΔV_{BE} , the sensor is switched between operating currents of I and $N \times I$. The resulting waveform is passed through a low-pass filter to remove noise, then to a chopper-stabilized amplifier that performs the functions of amplification and rectification of the waveform to produce a dc voltage proportional to ΔV_{BE} . This voltage is measured by the ADC to give a temperature output in 10-bit twos complement format. To further reduce the effects of noise, digital filtering is performed by averaging the results of 16 measurement cycles.

Layout Considerations

Digital boards can be electrically noisy environments, and care must be taken to protect the analog inputs from noise, particularly when measuring the very small voltages from a remote diode sensor. The following precautions should be taken:

1. Place the ADT7516/ADT7517/ADT7519 as close as possible to the remote sensing diode. Provided that the worst noise sources such as clock generators, data/address buses, and CRTs are avoided, this distance can be 4 inches to 8 inches.
2. Route the D+ and D- tracks close together, in parallel, with grounded guard tracks on each side. Provide a ground plane under the tracks, if possible.
3. Use wide tracks to minimize inductance and reduce noise pickup. A 10 mil track minimum width and spacing is recommended.



Figure 54. Arrangement of Signal Tracks

4. Try to minimize the number of copper/solder joints, which can cause thermocouple effects. Where copper/solder joints are used, make sure that they are in both the D+ and D- path and at the same temperature.

Thermocouple effects should not be a major problem because 1°C corresponds to about 240 μ V, and thermocouple voltages are about 3 μ V/°C of temperature difference. Unless there are two thermocouples with a big temperature differential between them, thermocouple voltages should be much less than 200 mV.

5. Place 0.1 μ F bypass and 2200 pF input filter capacitors close to the ADT7516/ADT7517/ADT7519.
6. If the distance to the remote sensor is more than 8 inches, the use of twisted-pair cable is recommended. This will work up to about 6 feet to 12 feet.
7. For long distances (up to 100 feet), use shielded twisted-pair cable, such as Belden #8451 microphone cable. Connect the twisted pair to D+ and D-, and the shield to GND close to the ADT7516/ADT7517/ADT7519. Leave the remote end of the shield unconnected to avoid ground loops.

Because the measurement technique uses switched current sources, excessive cable and/or filter capacitance can affect the measurement. When using long cables, the filter capacitor may be reduced or removed.

Cable resistance can also introduce errors. Series resistance of 1 Ω introduces about 0.5°C error.

Temperature Value Format

One LSB of the ADC corresponds to 0.25°C. The ADC can theoretically measure a temperature span of 255°C. The internal temperature sensor is guaranteed to a low value limit of -40°C. It is possible to measure the full temperature span using the external temperature sensor. The temperature data format is shown in Table 9.

The result of the internal or external temperature measurements is stored in the temperature value registers, and is compared with limits programmed into the internal or external high and low registers.

ADT7516/ADT7517/ADT7519

Table 9. Temperature Data Format (Internal and External Temperature)

Temperature	Digital Output
-40°C	11 0110 0000
-25°C	11 1001 1100
-10°C	11 1101 1000
-0.25°C	11 1111 1111
0°C	00 0000 0000
+0.25°C	00 0000 0001
+10°C	00 0010 1000
+25°C	00 0110 0100
+50°C	00 1100 1000
+75°C	01 0010 1100
+100°C	01 1001 0000
+105°C	01 1010 0100
+125°C	01 1111 0100

Temperature conversion formula:

$$\text{Positive Temperature} = \text{ADC Code}/4$$

$$\text{Negative Temperature} = (\text{ADC Code}^* - 512)/4$$

*where DB9 is removed from the ADC code.

Interrupts

The measured results from the internal temperature sensor, external temperature sensor, V_{DD} pin, and AIN inputs are compared with the T_{HIGH}/V_{HIGH} (greater than comparison) and T_{LOW}/V_{LOW} (less than or equal to comparison) limits. An interrupt occurs if the measurement exceeds or equals the limit registers. These limits are stored in on-chip registers. Note that the limit registers are 8 bits long while the conversion results are 10 bits long. If the limits are not masked, any out-of-limit comparisons generate flags that are stored in the Interrupt Status 1 register (Address 00h) and Interrupt Status 2 register (Address 01h). One or more out-of-limit results will cause the $\overline{\text{INT}}/\text{INT}$ output to pull either high or low depending on the output polarity setting. It is good design practice to mask out interrupts for channels that are of no concern to the application.

Figure 53 shows the interrupt structure for the ADT7516/ADT7517/ADT7519. It gives a block diagram representation of how the various measurement channels affect the $\overline{\text{INT}}/\text{INT}$ pin.

ADT7516/ADT7517/ADT7519 REGISTERS

The ADT7516/ADT7517/ADT7519 contain registers that are used to store the results of external and internal temperature measurements, V_{DD} value measurements, analog input measurements, high and low temperature limits, supply voltage and analog input limits, set output DAC voltage levels, configure multipurpose pins, and generally to control the device. A description of these registers follows.

The register map is divided into registers of 8 bits. Each register has its own individual address, but some consist of data that is linked with other registers. These registers hold the 10-bit conversion results of measurements taken on the temperature,

V_{DD} , and AIN channels. For example, the eight MSBs of the V_{DD} measurement are stored in register Address 06h while the two LSBs are stored in register Address 03h. The link involved between these types of registers is that when the LSB register is read first, the MSB registers associated with that LSB register are locked to prevent any updates. To unlock these MSB registers, the user has only to read any one of them, which will have the effect of unlocking all previously locked MSB registers. So for the preceding example, if Register 03h was read first, MSB Registers 06h and 07h would be locked to prevent any updates to them. If Register 06h was read, this register and Register 07h would be subsequently unlocked.

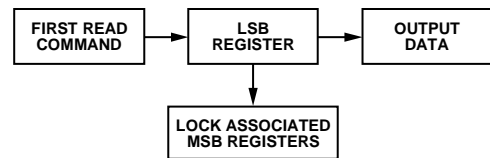

Figure 55. Phase 1 of 10-Bit Read

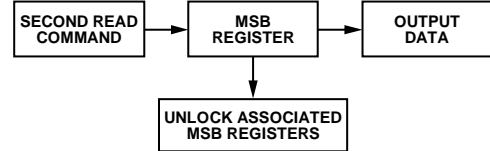

Figure 56. Phase 2 of 10-Bit Read

If an MSB register is read first, its corresponding LSB register is not locked, leaving the user with the option of just reading back 8 bits (MSB) of a 10-bit conversion result. Reading an MSB register first does not lock other MSB registers, and likewise reading an LSB register first does not lock other LSB registers.

Table 10. ADT7516/ADT7517/ADT7519 Registers

RD/WR Address	Name	Power-On Default
00h	Interrupt Status 1	00h
01h	Interrupt Status 2	00h
02h	Reserved	
03h	Internal Temp and V_{DD} LSBs	00h
04h	External Temp and AIN1 to AIN4 LSBs	00h
05h	Reserved	00h
06h	V_{DD} MSBs	xxh
07h	Internal Temp MSBs	00h
08h	External Temp MSBs/AIN1 MSBs	00h
09h	AIN2 MSBs	00h
0Ah	AIN3 MSBs	00h
0Bh	AIN4 MSBs	00h
0Ch-0Fh	Reserved	00h
10h	DAC A LSBs (ADT7516/ADT7517 only)	00h
11h	DAC A MSBs	00h
12h	DAC B LSBs (ADT7516/ADT7517 only)	00h
13h	DAC B MSBs	00h
14h	DAC C LSBs (ADT7516/ADT7517 only)	00h

RD/WR Address	Name	Power-On Default
15h	DAC C MSBs	00h
16h	DAC D LSBs (ADT7516/ADT7517 only)	00h
17h	DAC D MSBs	00h
18h	Control CONFIGURATION 1	00h
19h	Control CONFIGURATION 2	00h
1Ah	Control CONFIGURATION 3	00h
18h	DAC CONFIGURATION	00h
1Ch	LDAC CONFIGURATION	00h
1Dh	Interrupt Mask 1	00h
1Eh	Interrupt Mask 2	00h
1Fh	Internal Temp Offset	00h
20h	External Temp Offset	00h
21h	Internal Analog Temp Offset	D8h
22h	External Analog Temp Offset	D8h
23h	V _{DD} V _{HIGH} Limit	C7h
24h	V _{DD} V _{LOW} Limit	62h
25h	Internal T _{HIGH} Limit	64h
26h	Internal T _{LOW} Limit	C9h
27h	External T _{HIGH} /AIN1 V _{HIGH} Limits	FFh
28h	External T _{LOW} /AIN1 V _{LOW} Limits	00h
29h–2Ah	Reserved	
2Bh	AIN2 V _{HIGH} Limit	FFh
2Bh	AIN2 V _{HIGH} Limit	FFh
2Ch	AIN2 V _{LOW} Limit	00h
2Dh	AIN3 V _{HIGH} Limit	FFh
2Eh	AIN3 V _{LOW} Limit	00h
2Fh	AIN4 V _{HIGH} Limit	FFh
30h	AIN4 V _{LOW} Limit	00h
31h–4Ch	Reserved	
4Dh	Device ID	03h/0Bh/07h
4Eh	Manufacturer's ID	41h
4Fh	Silicon Revision	04h
50h–7Eh	Reserved	00h
7Fh	SPI Lock Status	00h
80h–FFh	Reserved	00h

Interrupt Status 1 Register (Read-Only) [Add. = 00h]

This 8-bit read-only register reflects the status of some of the interrupts that can cause the INT/ $\overline{\text{INT}}$ pin to go active. This register is reset by a read operation, provided that any out-of-limit event has been corrected. It is also reset by a software reset.

Table 11. Interrupt Status 1 Register

D7	D6	D5	D4	D3	D2	D1	D0
0*	0*	0*	0*	0*	0*	0*	0*

*Default settings at power-up.

Table 12.

Bit	Function
D0	1 when the internal temperature value exceeds T _{HIGH} limit. Any internal temperature reading greater than the set limit will cause an out-of-limit event.
D1	1 when internal temperature value exceeds T _{LOW} limit. Any internal temperature reading less than or equal to the set limit will cause an out-of-limit event.
D2	This status bit is linked to the configuration of Pins 7 and 8. If configured for external temperature sensor, this bit is 1 when external temperature value exceeds T _{HIGH} limit. The default value for this limit register is –1°C, so any external temperature reading greater than the set limit will cause an out-of-limit event. If configured for AIN1 and AIN2, this bit is 1 when AIN1 input voltage exceeds V _{HIGH} or V _{LOW} limits.
D3	1 when external temperature value exceeds T _{LOW} limit. The default value for this limit register is 0°C, so any external temperature reading less than or equal to the set limit will cause an out-of-limit event.
D4	1 Indicates a fault (open or short) for the external temperature sensor.
D5	1 when AIN2 voltage is greater than its corresponding V _{HIGH} limit. 1 when AIN2 voltage is less than or equal to its corresponding V _{LOW} limit.
D6	1 when AIN3 voltage is greater than its corresponding V _{HIGH} limit. 1 when AIN3 voltage is less than or equal to its corresponding V _{LOW} limit.
D7	1 when AIN4 voltage is greater than its corresponding V _{HIGH} limit. 1 when AIN4 voltage is less than or equal to its corresponding V _{LOW} limit.

Interrupt Status 2 Register (Read-Only) [Add. = 01h]

This 8-bit read-only register reflects the status of the V_{DD} interrupt that can cause the INT/ $\overline{\text{INT}}$ pin to go active. This register is reset by a read operation, provided that any out-of-limit event has been corrected. It is also reset by a software reset.

Table 13. Interrupt Status 2 Register

D7	D6	D5	D4	D3	D2	D1	D0
N/A	N/A	N/A	0*	N/A	N/A	N/A	N/A

*Default settings at power-up.

Table 14.

Bit	Function
D4	1 when V _{DD} value is greater than its corresponding V _{HIGH} limit. 1 when V _{DD} is less than or equal to its corresponding V _{LOW} limit.

ADT7516/ADT7517/ADT7519

Internal Temperature Value/V_{DD} Value Register LSBs (Read-Only) [Add. = 03h]

This 8-bit read-only register stores the two LSBs of the 10-bit temperature reading from the internal temperature sensor and the two LSBs of the 10-bit supply voltage reading.

Table 15. Internal Temperature/V_{DD} LSBs

D7	D6	D5	D4	D3	D2	D1	D0
N/A	N/A	N/A	N/A	V1	LSB	T1	LSB
N/A	N/A	N/A	N/A	0*	0*	0*	0*

*Default settings at power-up.

Table 16.

Bit	Function
D0	LSB of Internal Temperature Value.
D1	B1 of Internal Temperature Value.
D2	LSB of V _{DD} Value.
D3	B1 of V _{DD} Value.

External Temperature Value and Analog Inputs 1 to 4 Register LSBs (Read-Only) [Add. = 04h]

This is an 8-bit read-only register. Bits D2:D7 store the two LSBs of the analog inputs AIN2–AIN4. Bits D0:D1 store the two LSBs of either the external temperature value or AIN1 input value. The type of input for D0 and D1 is selected by Bits C1:C2 of the Control Configuration Register 1.

Table 17. External Temperature and AIN1 to AIN4 LSBs

D7	D6	D5	D4	D3	D2	D1	D0
A4	A4 _{LSB}	A3	A3 _{LSB}	A2	A2 _{LSB}	T/A	T/A _{LSB}
0*	0*	0*	0*	0*	0*	0*	0*

*Default settings at power-up.

Table 18.

Bit	Function
D0	LSB of External Temperature Value or AIN1 Value.
D1	Bit 1 of External Temperature Value or AIN1 Value.
D2	LSB of AIN2 Value.
D3	Bit 1 of AIN2 Value.
D4	LSB of AIN3 Value.
D5	Bit 1 of AIN3 Value.
D6	LSB of AIN4 Value.
D7	Bit 1 of AIN4 Value.

V_{DD} Value Register MSBs (Read-Only) [Add. = 6h]

This 8-bit read-only register stores the supply voltage value. The eight MSBs of the 10-bit value are stored in this register.

Table 19. V_{DD} Value MSBs

D7	D6	D5	D4	D3	D2	D1	D0
V9	V8	V7	V6	V5	V4	V3	V2
x*	x*	x*	x*	x*	x*	x*	x*

*Loaded with V_{DD} value after power-up.

Internal Temperature Value Register MSBs (Read-Only) [Add. = 07h]

This 8-bit read-only register stores the internal temperature value from the internal temperature sensor in twos complement format. The eight MSBs of the 10-bit value are stored in this register.

Table 20. Internal Temperature Value MSBs

D7	D6	D5	D4	D3	D2	D1	D0
T9	T8	T7	T6	T5	T4	T3	T2
0*	0*	0*	0*	0*	0*	0*	0*

*Default settings at power-up.

External Temperature Value or Analog Input AIN1 Register MSBs (Read-Only) [Add. = 08h]

This 8-bit read-only register stores, if selected, the external temperature value or the analog input AIN1 value. Selection is done in the Control Configuration 1 register. The external temperature value is stored in twos complement format. The eight MSBs of the 10-bit value are stored in this register.

Table 21. External Temperature Value/Analog Inputs MSBs

D7	D6	D5	D4	D3	D2	D1	D0
T/A9	T/A8	T/A7	T/A6	T/A5	T/A4	T/A3	T/A2
0*	0*	0*	0*	0*	0*	0*	0*

*Default settings at power-up.

AIN2 Register MSBs (Read) [Add. = 09h]

This 8-bit read register contains the eight MSBs of the AIN2 analog input voltage word. The value in this register is combined with Bits D2:3 of the external temperature value and Analog Inputs 1 to 4 register LSBs, Address 04h, to give the full 10-bit conversion result of the analog value on the AIN2 pin.

Table 22. AIN2 MSBs

D7	D6	D5	D4	D3	D2	D1	D0
MSB	A8	A7	A6	A5	A4	A3	A2
0*	0*	0*	0*	0*	0*	0*	0*

*Default settings at power-up.

AIN3 Register MSBs (Read) [Add. = 0Ah]

This 8-bit read register contains the eight MSBs of the AIN3 analog input voltage word. The value in this register is combined with Bits D4:5 of the external temperature value and Analog Inputs 1 to 4 register LSBs, Address 04h, to give the full 10-bit conversion result of the analog value on the AIN3 pin.

Table 23. AIN3 MSBs

D7	D6	D5	D4	D3	D2	D1	D0
MSB	A8	A7	A6	A5	A4	A3	A2
0*	0*	0*	0*	0*	0*	0*	0*

*Default settings at power-up.

AIN4 Register MSBs (Read) [Add. = 0Bh]

This 8-bit read register contains the eight MSBs of the AIN4 analog input voltage word. The value in this register is combined with Bits D6:7 of the external temperature value and Analog Inputs 1 to 4 register LSBs, Address 04h, to give the full 10-bit conversion result of the analog value on the AIN4 pin.

Table 24. AIN4 MSBs

D7	D6	D5	D4	D3	D2	D1	D0
MSB	A8	A7	A6	A5	A4	A3	A2
0*	0*	0*	0*	0*	0*	0*	0*

*Default settings at power-up.

DAC A Register LSBs (Read/Write) [Add. = 10h]

This 8-bit read/write register contains the 4/2 LSBs of the ADT7516/ADT7517 DAC A word, respectively. The value in this register is combined with the value in the DAC A register MSBs and converted to an analog voltage on the V_{OUT-A} pin. On power-up, the voltage output on the V_{OUT-A} pin is 0 V.

Table 25. DAC A (ADT7516) LSBs

D7	D6	D5	D4	D3	D2	D1	D0
B3	B2	B1	LSB	N/A	N/A	N/A	N/A
0*	0*	0*	0*	N/A	N/A	N/A	N/A

*Default settings at power-up.

Table 26. DAC A (ADT7517) LSBs

D7	D6	D5	D4	D3	D2	D1	D0
B1	LSB	N/A	N/A	N/A	N/A	N/A	N/A
0*	0*	N/A	N/A	N/A	N/A	N/A	N/A

*Default settings at power-up.

DAC A Register MSBs (Read/Write) [Add. = 11h]

This 8-bit read/write register contains the eight MSBs of the DAC A word. The value in this register is combined with the value in the DAC A register LSBs and converted to an analog voltage on the V_{OUT-A} pin. On power-up, the voltage output on the V_{OUT-A} pin is 0 V.

Table 27. DAC A MSBs

D7	D6	D5	D4	D3	D2	D1	D0
MSB	B8	B7	B6	B5	B4	B3	B2
0*	0*	0*	0*	0*	0*	0*	0*

*Default settings at power-up.

DAC B Register LSBs (Read/Write) [Add. = 12h]

This 8-bit read/write register contains the 4/2 LSBs of the ADT7516/ADT7517 DAC B word, respectively. The value in this register is combined with the value in the DAC B register MSBs and converted to an analog voltage on the V_{OUT-B} pin. On power-up, the voltage output on the V_{OUT-B} pin is 0 V.

Table 28. DAC B (ADT7516) LSBs

D7	D6	D5	D4	D3	D2	D1	D0
B3	B2	B1	LSB	N/A	N/A	N/A	N/A
0*	0*	0*	0*	N/A	N/A	N/A	N/A

*Default settings at power-up.

Table 29. DAC B (ADT7517) LSBs

D7	D6	D5	D4	D3	D2	D1	D0
B1	LSB	N/A	N/A	N/A	N/A	N/A	N/A
0*	0*	N/A	N/A	N/A	N/A	N/A	N/A

*Default settings at power-up.

DAC B Register MSBs (Read/Write) [Add. = 13h]

This 8-bit read/write register contains the eight MSBs of the DAC B word. The value combines with the value in the DAC B register LSBs and converts to an analog voltage on the V_{OUT-B} pin. On power-up, the voltage output on the V_{OUT-B} pin is 0 V.

Table 30. DAC B MSBs

D7	D6	D5	D4	D3	D2	D1	D0
MSB	B8	B7	B6	B5	B4	B3	B2
0*	0*	0*	0*	0*	0*	0*	0*

*Default settings at power-up.

DAC C Register LSBs (Read/Write) [Add. = 14h]

This 8-bit read/write register contains the 4/2 LSBs of the ADT7516/ADT7517 DAC C word, respectively. The value in this register is combined with the value in the DAC C register MSBs and converted to an analog voltage on the V_{OUT-C} pin. On power-up, the voltage output on the V_{OUT-C} pin is 0 V.

Table 31. DAC C (ADT7516) LSBs

D7	D6	D5	D4	D3	D2	D1	D0
B3	B2	B1	LSB	N/A	N/A	N/A	N/A
0*	0*	0*	0*	N/A	N/A	N/A	N/A

*Default settings at power-up.

Table 32. DAC C (ADT7517) LSBs

D7	D6	D5	D4	D3	D2	D1	D0
B1	LSB	N/A	N/A	N/A	N/A	N/A	N/A
0*	0*	N/A	N/A	N/A	N/A	N/A	N/A

*Default settings at power-up.

DAC C Register MSBs (Read/Write) [Add. = 15h]

This 8-bit read/write register contains the eight MSBs of the DAC C word. The value in this register is combined with the value in the DAC C register LSBs and converted to an analog voltage on the V_{OUT-C} pin. On power-up, the voltage output on the V_{OUT-C} pin is 0 V.

Table 33. DAC C MSBs

D7	D6	D5	D4	D3	D2	D1	D0
MSB	B8	B7	B6	B5	B4	B3	B2
0*	0*	0*	0*	0*	0*	0*	0*

*Default settings at power-up.

ADT7516/ADT7517/ADT7519

DAC D Register LSBs (Read/Write) [Add. = 16h]

This 8-bit read/write register contains the 4/2 LSBs of the ADT7516/ADT7517 DAC D word, respectively. The value in this register is combined with the value in the DAC D register MSBs and converted to an analog voltage on the V_{OUT-D} pin. On power-up, the voltage output on the V_{OUT-D} pin is 0 V.

Table 34. DAC D (ADT7516) LSBs

D7	D6	D5	D4	D3	D2	D1	D0
B3	B2	B1	LSB	N/A	N/A	N/A	N/A
0*	0*	0*	0*	N/A	N/A	N/A	N/A

*Default settings at power-up.

Table 35. DAC D (ADT7517) LSBs

D7	D6	D5	D4	D3	D2	D1	D0
B1	LSB	N/A	N/A	N/A	N/A	N/A	N/A
0*	0*	N/A	N/A	N/A	N/A	N/A	N/A

*Default settings at power-up.

DAC D Register MSBs (Read/Write) [Add. = 17h]

This 8-bit read/write register contains the eight MSBs of the DAC D word. The register value combines with the value in the DAC D register LSBs and converts to an analog voltage on the V_{OUT-D} pin. On power-up, the voltage output on the V_{OUT-D} pin is 0 V.

Table 36. DAC D MSBs

D7	D6	D5	D4	D3	D2	D1	D0
MSB	B8	B7	B6	B5	B4	B3	B2
0*	0*	0*	0*	0*	0*	0*	0*

*Default settings at power-up.

Control Configuration 1 Register (Read/Write) [Add. = 18h]

This configuration register is an 8-bit read/write register that is used to set up some of the operating modes of the ADT7516/ADT7517/ADT7519.

Table 37. Control Configuration 1

D7	D6	D5	D4	D3	D2	D1	D0
PD	C6	C5	C4	C3	C2	C1	C0
0*	0*	0*	0*	0*	0*	0*	0*

*Default settings at power-up.

Table 38.

Bit	Function
C0	This bit enables/disables conversions in round robin and single-channel mode. ADT7516/ADT7517/ADT7519 powers up in round robin mode but monitoring is not initiated until this bit is set. The default = 0. 0 = Stop monitoring. 1 = Start monitoring.
C2:C1	Selects between the two different analog inputs on Pins 7 and 8. ADT7516/ADT7517/ADT7519 powers up with AIN1 and AIN2 selected. 00 = AIN1 and AIN2 selected. 01 = Undefined. 10 = External TDM selected. 11 = Undefined.
C3	Selects between digital (LDAC) and analog inputs (AIN3) on Pin 9. When AIN3 is selected, Bit C3 of the Control Configuration 3 register is masked and has no effect until LDAC is selected as the input on Pin 9. 0 = LDAC selected. 1 = AIN3 selected.
C4	Reserved. Write 0 only.
C5	0 = Enable INT/ $\overline{\text{INT}}$ output. 1 = Disable INT/ $\overline{\text{INT}}$ output.
C6	Configures INT/ $\overline{\text{INT}}$ output polarity. 0 = Active low. 1 = Active high.
PD	Power-Down Bit. Setting this bit to 1 puts the ADT7516/ADT7517/ADT7519 into standby mode. In this mode, both ADC and DACs are fully powered down, but the serial interface is still operational. To power up the part again, just write 0 to this bit.

Control Configuration 2 Register (Read/Write) [Add. = 19h]

This configuration register is an 8-bit read/write register that is used to set up some of the operating modes of the ADT7516/ADT7517/ADT7519.

Table 39. Control Configuration 2

D7	D6	D5	D4	D3	D2	D1	D0
C7	C6	C5	C4	C3	C2	C1	C0
0*	0*	0*	0*	0*	0*	0*	0*

*Default settings at power-up.

Table 40.

Bit	Function
C2:0	In single-channel mode, these bits select between V_{DD} , the internal temperature sensor, external temperature sensor/AIN1, AIN2, AIN3, and AIN4 for conversion. The default is V_{DD} . 000 = V_{DD} . 001 = Internal temperature sensor. 010 = External temperature sensor/AIN1. (Bits C1:C2 of the Control Configuration 1 register affect this selection). 011 = AIN2. 100 = AIN3. 101 = AIN4. 110–111 = Reserved.
C3	Reserved.
C4	Selects between single-channel and round robin conversion cycle. The default is round robin. 0 = Round robin. 1 = Single channel.
C5	Default condition is to average every measurement on all channels 16 times. This bit disables this averaging. Channels affected are temperature, analog inputs, and V_{DD} . 0 = Enable averaging. 1 = Disable averaging.
C6	SMBus timeout on the serial clock puts a 25 ms limit on the pulse width of the clock, ensuring that a fault on the master SCL does not lock up the SDA line. 0 = Disable SMBus timeout. 1 = Enable SMBus timeout.
C7	Software Reset. Setting this bit to 1 causes a software reset. All registers and DAC outputs will reset to their default settings.

Control Configuration 3 Register (Read/Write) [Add. = 1Ah]

This configuration register is an 8-bit read/write register that is used to set up some of the operating modes of the ADT7516/ADT7517/ADT7519.

Table 41. Control Configuration 3

D7	D6	D5	D4	D3	D2	D1	D0
C7	C6	C5	C4	C3	C2	C1	C0
0*	0*	0*	0*	0*	0*	0*	0*

*Default settings at power-up.

Table 42.

Bit	Function
C0	Selects between fast and slow ADC conversion speeds. 0 = ADC clock at 1.4 kHz. 1 = ADC clock at 22.5 kHz. D+ and D– analog filters are disabled.
C1	On the ADT7516 and ADT7517, this bit selects between 8-bit and 10-bit DAC output resolution on the thermal voltage output feature. The default is 8 bits. This bit has no effect on the ADT7519 output because this part has only an 8-bit DAC. For the ADT7519, write 0 to this bit.

Bit	Function
	0 = 8-bit resolution. 1 = 10-bit resolution.
C2	Reserved. Write 0 only.
C3	0 = LDAC pin controls updating of DAC outputs. 1 = DAC configuration register and LDAC configuration register control updating of DAC outputs.
C4	Selects the ADC reference to be either internal V_{REF} or V_{DD} for analog inputs. 0 = Internal V_{REF} . 1 = V_{DD} .
C5	Setting this bit selects DAC A voltage output to be proportional to the internal temperature measurement.
C6	Setting this bit selects DAC B voltage output to be proportional to the external temperature measurement.
C7	Reserved. Write 0 only.

DAC Configuration Register (Read/Write) [Add. = 1Bh]

This configuration register is an 8-bit read/write register that is used to control the output ranges of all four DACs and also to control the loading of the DAC registers if the LDAC pin is disabled (Bit C3 = 1, Control Configuration 3 register).

Table 43. DAC Configuration

D7	D6	D5	D4	D3	D2	D1	D0
D7	D6	D5	D4	D3	D2	D1	D0
0*	0*	0*	0*	0*	0*	0*	0*

*Default settings at power-up.

Table 44.

Bit	Function
D0	Selects the output range of DAC A. 0 = 0 V to V_{REF} . 1 = 0 V to $2V_{REF}$.
D1	Selects the output range of DAC B. 0 = 0 V to V_{REF} . 1 = 0 V to $2V_{REF}$.
D2	Selects the output range of DAC C. 0 = 0 V to V_{REF} . 1 = 0 V to $2V_{REF}$.
D3	Selects the output range of DAC D. 0 = 0 V to V_{REF} . 1 = 0 V to $2V_{REF}$.
D5:D4	00 = MSB write to any DAC register generates LDAC command that updates that DAC only. 01 = MSB write to DAC B or DAC D register generates LDAC command that updates DACs A, B or DACs C, D, respectively. 10 = MSB write to DAC D register generates LDAC command that updates all four DACs. 11 = LDAC command generated from LDAC register.
D6:D7	Reserved. Write 0s only.

LDAC Configuration Register (Write-Only) [Add. = 1Ch]

This configuration register is an 8-bit write register that is used to control the updating of the quad DAC outputs if the LDAC pin is disabled and Bits D4:D5 of the DAC configuration register are both set to 1. Also selects either the internal or external V_{REF} for all four DACs. Bits D0:D3 in this register are self-clearing, i.e., reading back from this register will always give 0s for these bits.

Table 45. LDAC Configuration

D7	D6	D5	D4	D3	D2	D1	D0
D7	D6	D5	D4	D3	D2	D1	D0
0*	0*	0*	0*	0*	0*	0*	0*

*Default settings at power-up.

Table 46.

Bit	Function
D0	Writing a 1 to this bit will generate the LDAC command to update DAC A output only.
D1	Writing a 1 to this bit will generate the LDAC command to update DAC B output only.
D2	Writing a 1 to this bit will generate the LDAC command to update DAC C output only.
D3	Writing a 1 to this bit will generate the LDAC command to update DAC D output only.
D4	Selects either internal V_{REF} or external V_{REF} for DACs A and B. 0 = External V_{REF} 1 = Internal V_{REF} .
D5	Selects either internal V_{REF} or external V_{REF} for DACs C and D. 0 = External V_{REF} 1 = Internal V_{REF} .
D6:D7	Reserved. Write 0s only.

Interrupt Mask 1 Register (Read/Write) [Add. = 1Dh]

This mask register is an 8-bit read/write register that can be used to mask any interrupts that can cause the INT/INT pin to go active.

Table 47. Interrupt Mask 1

D7	D6	D5	D4	D3	D2	D1	D0
D7	D6	D5	D4	D3	D2	D1	D0
0*	0*	0*	0*	0*	0*	0*	0*

*Default settings at power-up.

Table 48.

Bit	Function
D0	0 = Enable internal T_{HIGH} interrupt. 1 = Disable internal T_{HIGH} interrupt.
D1	0 = Enable internal T_{LOW} interrupt. 1 = Disable internal T_{LOW} interrupt.
D2	0 = Enable external T_{HIGH} interrupt or AIN1 interrupt. 1 = Disable external T_{HIGH} interrupt or AIN1 interrupt.
D3	0 = Enable external T_{LOW} interrupt. 1 = Disable external T_{LOW} interrupt.
D4	0 = Enable external temperature fault interrupt. 1 = Disable external temperature fault interrupt.
D5	0 = Enable AIN2 interrupt. 1 = Disable AIN2 interrupt.
D6	0 = Enable AIN3 interrupt. 1 = Disable AIN3 interrupt.
D7	0 = Enable AIN4 interrupt. 1 = Disable AIN4 interrupt.

Interrupt Mask 2 Register (Read/Write) [Add. = 1Eh]

This mask register is an 8-bit read/write register that can be used to mask any interrupts that can cause the INT/INT pin to go active.

Table 49. Interrupt Mask 2

D7	D6	D5	D4	D3	D2	D1	D0
D7	D6	D5	D4	D3	D2	D1	D0
0*	0*	0*	0*	0*	0*	0*	0*

*Default settings at power-up.

Table 50.

Bit	Function
D0:D3	Reserved. Write 0s only.
D4	0 = Enable V_{DD} interrupts. 1 = Disable V_{DD} interrupts.
D5:D7	Reserved. Write 0s only.

Internal Temperature Offset Register (Read/Write) [Add. = 1Fh]

This register contains the offset value for the internal temperature channel. A two's complement number can be written to this register which is then added to the measured result before it is stored or compared to limits. In this way, a one-point calibration can be done whereby the whole transfer function of the channel can be moved up or down. From a software point of view, this may be a very simple method to vary the characteristics of the measurement channel if the thermal characteristics change. Because it is an 8-bit register, the temperature resolution is 1°C.

Table 51. Internal Temperature Offset

D7	D6	D5	D4	D3	D2	D1	D0
D7	D6	D5	D4	D3	D2	D1	D0
0*	0*	0*	0*	0*	0*	0*	0*

**External Temperature Offset Register (Read/Write)
[Add. = 20h]**

This register contains the offset value for the external temperature channel. A twos complement number can be written to this register, which is then added to the measured result before it is stored or compared to limits. In this way, a one-point calibration can be done whereby the whole transfer function of the channel can be moved up or down. From a software point of view, this may be a very simple method to vary the characteristics of the measurement channel if the thermal characteristics change. Because it is an 8-bit register, the temperature resolution is 1°C.

Table 52. External Temperature Offset

D7	D6	D5	D4	D3	D2	D1	D0
D7	D6	D5	D4	D3	D2	D1	D0
0*	0*	0*	0*	0*	0*	0*	0*

*Default settings at power-up.

Internal Analog Temperature Offset Register (Read/Write) [Add. = 21h]

This register contains the offset value for the internal thermal voltage output. A twos complement number can be written to this register, which is then added to the measured result before it is converted by DAC A. Varying the value in this register has the effect of varying the temperature span. For example, the output voltage can represent a temperature span of -128°C to +127°C or even 0°C to +127°C. In essence, this register changes the position of 0 V on the temperature scale. Temperatures other than -128°C to +127°C will produce an upper deadband on the DAC A output. Because it is an 8-bit register, the temperature resolution is 1°C. The default value is -40°C.

Table 53. Internal Analog Temperature Offset

D7	D6	D5	D4	D3	D2	D1	D0
D7	D6	D5	D4	D3	D2	D1	D0
1*	1*	0*	1*	1*	0*	0*	0*

*Default settings at power-up.

External Analog Temperature Offset Register (Read/Write) [Add. = 22h]

This register contains the offset value for the external thermal voltage output. A twos complement number can be written to this register which is then added to the measured result before it is converted by DAC B. Varying the value in this register has the effect of varying the temperature span. For example, the output voltage can represent a temperature span of -128°C to +127°C or even 0°C to +127°C. In essence, this register changes the position of 0 V on the temperature scale. Temperatures other than -128°C to +127°C will produce an upper deadband on the DAC B output. Because it is an 8-bit register, the temperature resolution is 1°C. The default value is -40°C.

Table 54. External Analog Temperature Offset

D7	D6	D5	D4	D3	D2	D1	D0
D7	D6	D5	D4	D3	D2	D1	D0
1*	1*	0*	1*	1*	0*	0*	0*

*Default settings at power-up.

V_{DD} V_{HIGH} Limit Register (Read/Write) [Add. = 23h]

This limit register is an 8-bit read/write register that stores the V_{DD} upper limit, which will cause an interrupt and activate the INT/ $\overline{\text{INT}}$ output (if enabled). For this to happen, the measured V_{DD} value has to be greater than the value in this register. The default value is 5.46 V.

Table 55. V_{DD} V_{HIGH} Limit

D7	D6	D5	D4	D3	D2	D1	D0
D7	D6	D5	D4	D3	D2	D1	D0
1*	1*	0*	0*	0*	1*	1*	1*

*Default settings at power-up.

V_{DD} V_{LOW} Limit Register (Read/Write) [Add. = 24h]

This limit register is an 8-bit read/write register that stores the V_{DD} lower limit, which will cause an interrupt and activate the INT/ $\overline{\text{INT}}$ output (if enabled). For this to happen, the measured V_{DD} value has to be less than or equal to the value in this register. The default value is 2.7 V.

Table 56. V_{DD} V_{LOW} Limit

D7	D6	D5	D4	D3	D2	D1	D0
D7	D6	D5	D4	D3	D2	D1	D0
0*	1*	1*	0*	0*	0*	1*	0*

*Default settings at power-up.

Internal T_{HIGH} Limit Register (Read/Write) [Add. = 25h]

This limit register is an 8-bit read/write register that stores the twos complement of the internal temperature upper limit, which will cause an interrupt and activate the INT/ $\overline{\text{INT}}$ output (if enabled). For this to happen, the measured internal temperature value has to be greater than the value in this register. Because it is an 8-bit register, the temperature resolution is 1°C. The default value is +100°C.

Table 57. Internal T_{HIGH} Limit

D7	D6	D5	D4	D3	D2	D1	D0
D7	D6	D5	D4	D3	D2	D1	D0
0*	1*	1*	0*	0*	1*	0*	0*

*Default settings at power-up.

ADT7516/ADT7517/ADT7519

Internal T_{LOW} Limit Register (Read/Write) [Add. = 26h]

This limit register is an 8-bit read/write register that stores the two's complement of the internal temperature lower limit, which will cause an interrupt and activate the $\overline{INT}/\overline{INT}$ output (if enabled). For this to happen, the measured internal temperature value has to be more negative than or equal to the value in this register. Because it is an 8-bit register, the temperature resolution is 1°C. The default value is -55°C.

Table 58. Internal T_{LOW} Limit

D7	D6	D5	D4	D3	D2	D1	D0
D7	D6	D5	D4	D3	D2	D1	D0
1*	1*	0*	0*	1*	0*	0*	1*

External $T_{HIGH}/AIN1 V_{HIGH}$ Limit Register (Read/Write) [Add. = 27h]

If Pins 7 and 8 are configured for the external temperature sensor, this limit register is an 8-bit read/write register that stores the two's complement of the external temperature upper limit, which will cause an interrupt and activate the $\overline{INT}/\overline{INT}$ output (if enabled). For this to happen, the measured external temperature value has to be greater than the value in this register. Because it is an 8-bit register, the temperature resolution is 1°C. The default value is -1°C.

If Pins 7 and 8 are configured for AIN1 and AIN2 inputs, this limit register is an 8-bit read/write register that stores the AIN1 input upper limit, which will cause an interrupt and activate the $\overline{INT}/\overline{INT}$ output (if enabled). For this to happen, the measured AIN1 value has to be greater than the value in this register. Because it is an 8-bit register, the resolution is four times less than the resolution of the 10-bit ADC. Because the power-up default settings for Pins 7 and 8 are AIN1 and AIN2 inputs, the default value for this limit register is full-scale voltage.

Table 59. AIN1 V_{HIGH} Limit

D7	D6	D5	D4	D3	D2	D1	D0
D7	D6	D5	D4	D3	D2	D1	D0
1*	1*	1*	1*	1*	1*	1*	1*

*Default settings at power-up.

External $T_{LOW}/AIN1 V_{LOW}$ Limit Register (Read/Write) [Add. = 28h]

If Pins 7 and 8 are configured for the external temperature sensor, this limit register is an 8-bit read/write register that stores the two's complement of the external temperature lower limit, which will cause an interrupt and activate the $\overline{INT}/\overline{INT}$ output (if enabled). For this to happen, the measured external temperature value has to be more negative than or equal to the value in this register. Because it is an 8-bit register, the temperature resolution is 1°C. The default value is 0°C.

If Pins 7 and 8 are configured for AIN1 and AIN2 inputs, this limit register is an 8-bit read/write register that stores the AIN1 input lower limit, which will cause an interrupt and activate the

$\overline{INT}/\overline{INT}$ output (if enabled). For this to happen, the measured AIN1 value has to be less than or equal to the value in this register. As it is an 8-bit register, the resolution is four times less than the resolution of the 10-bit ADC. Because the power-up default settings for Pins 7 and 8 are AIN1 and AIN2 inputs, the default value for this limit register is 0 V.

Table 60. AIN1 V_{LOW} Limit

D7	D6	D5	D4	D3	D2	D1	D0
D7	D6	D5	D4	D3	D2	D1	D0
0*	0*	0*	0*	0*	0*	0*	0*

*Default settings at power-up.

AIN2 V_{HIGH} Limit Register (Read/Write) [Add. = 2Bh]

This limit register is an 8-bit read/write register that stores the AIN2 input upper limit, which will cause an interrupt and activate the $\overline{INT}/\overline{INT}$ output (if enabled). For this to happen, the measured AIN2 value has to be greater than the value in this register. Because it is an 8-bit register, the resolution is four times less than the resolution of the 10-bit ADC. The default value is full-scale voltage.

Table 61. AIN2 V_{HIGH} Limit

D7	D6	D5	D4	D3	D2	D1	D0
D7	D6	D5	D4	D3	D2	D1	D0
1*	1*	1*	1*	1*	1*	1*	1*

*Default settings at power-up.

AIN2 V_{LOW} Limit Register (Read/Write) [Add. = 2Ch]

This limit register is an 8-bit read/write register that stores the AIN2 input lower limit, which will cause an interrupt and activate the $\overline{INT}/\overline{INT}$ output (if enabled). For this to happen, the measured AIN2 value has to be less than or equal to the value in this register. Because it is an 8-bit register, the resolution is four times less than the resolution of the 10-bit ADC. The default value is 0 V.

Table 62. AIN2 V_{LOW} Limit

D7	D6	D5	D4	D3	D2	D1	D0
D7	D6	D5	D4	D3	D2	D1	D0
0*	0*	0*	0*	0*	0*	0*	0*

AIN3 V_{HIGH} Limit Register (Read/Write) [Add. = 2Dh]

This limit register is an 8-bit read/write register that stores the AIN3 input upper limit, which will cause an interrupt and activate the $\overline{INT}/\overline{INT}$ output (if enabled). For this to happen, the measured AIN3 value has to be greater than the value in this register. Because it is an 8-bit register, the resolution is four times less than the resolution of the 10-bit ADC. The default value is full-scale voltage.

Table 63. AIN3 V_{HIGH} Limit

D7	D6	D5	D4	D3	D2	D1	D0
D7	D6	D5	D4	D3	D2	D1	D0
1*	1*	1*	1*	1*	1*	1*	1*

*Default settings at power-up.

AIN3 V_{LOW} Limit Register (Read/Write) [Add. = 2Eh]

This limit register is an 8-bit read/write register that stores the AIN3 input lower limit, which will cause an interrupt and activate the INT/INT output (if enabled). For this to happen, the measured AIN3 value has to be less than or equal to the value in this register. Because it is an 8-bit register, the resolution is four times less than the resolution of the 10-bit ADC. The default value is 0 V.

Table 64. AIN3 V_{LOW} Limit

D7	D6	D5	D4	D3	D2	D1	D0
D7	D6	D5	D4	D3	D2	D1	D0
0*	0*	0*	0*	0*	0*	0*	0*

*Default settings at power-up.

AIN4 V_{HIGH} Limit Register (Read/Write) [Add. = 2Fh]

This limit register is an 8-bit read/write register that stores the AIN4 input upper limit, which will cause an interrupt and activate the INT/INT output (if enabled). For this to happen, the measured AIN4 value has to be greater than the value in this register. Because it is an 8-bit register, the resolution is four times less than the resolution of the 10-bit ADC. The default value is full-scale voltage.

Table 65. AIN4 V_{HIGH} Limit

D7	D6	D5	D4	D3	D2	D1	D0
D7	D6	D5	D4	D3	D2	D1	D0
1*	1*	1*	1*	1*	1*	1*	1*

*Default settings at power-up.

AIN4 V_{LOW} Limit Register (Read/Write) [Add. = 30h]

This limit register is an 8-bit read/write register that stores the AIN4 input lower limit, which will cause an interrupt and activate the INT/INT output (if enabled). For this to happen, the measured AIN4 value has to be less than or equal to the value in this register. Because it is an 8-bit register, the resolution is four times less than the resolution of the 10-bit ADC. The default value is 0 V.

Table 66. AIN4 V_{LOW} Limit

D7	D6	D5	D4	D3	D2	D1	D0
D7	D6	D5	D4	D3	D2	D1	D0
0*	0*	0*	0*	0*	0*	0*	0*

*Default settings at power-up.

Device ID Register (Read-Only) [Add. = 4Dh]

This 8-bit read-only register indicates which part the device is in the model range. ADT7516 = 03h, ADT7517 = 07h, and ADT7519 = 0Bh.

Manufacturer's ID Register (Read-Only) [Add. = 4Eh]

This register contains the manufacturer's identification number. ADI's ID number is 41h.

Silicon Revision Register (Read-Only) [Add. = 4Fh]

This register is divided into the four LSBs representing the stepping and the four MSBs representing the version. The stepping contains the manufacturer's code for minor revisions or steppings to the silicon. The version is the ADT7516/ADT7517/ADT7519 version number.

SPI Lock Status Register (Read-Only) [Add. = 7Fh]

Bit D0 (LSB) of this read-only register indicates whether or not the SPI interface is locked. Writing to this register will cause the device to malfunction. The default value is 00h.

0 = I²C interface.

1 = SPI interface selected and locked.

SERIAL INTERFACE

There are two serial interfaces that can be used on this part: I²C and SPI. The device will power up with the serial interface in I²C mode, but it is not locked into this mode. To stay in I²C mode, it is recommended that the user tie the CS line to either V_{CC} or GND. It is not possible to lock the I²C mode, but it is possible to select and lock the SPI mode.

To select and lock the interface into the SPI mode, a number of pulses must be sent down the CS line (Pin 4). The following section describes how this is done.

Once the SPI communication protocol has been locked in, it cannot be unlocked while the device is still powered up. Bit D0 of the SPI lock status register (Address 7Fh) is set to 1 when a successful SPI interface lock has been accomplished. To reset the serial interface, the user must power down the part and power it up again. A software reset does not reset the serial interface.

Serial Interface Selection

The CS line controls the selection between I²C and SPI.

Figure 59 shows the selection process necessary to lock the SPI interface mode.

To communicate to the ADT7516/ADT7517/ADT7519 using the SPI protocol, send three pulses down the CS line as shown in Figure 59. On the third rising edge (marked as C in Figure 59), the part selects and locks the SPI interface. The user is now limited to communicating to the device using the SPI protocol.

As per most SPI standards, the CS line must be low during every SPI communication to the ADT7516/ADT7517/ADT7519 and high all other times. Typical examples of how to connect the dual interface as I²C or SPI is shown in Figure 57 and Figure 58. The following sections describe in detail how to use the I²C and SPI protocols associated with the ADT7516/ADT7517/ADT7519.

ADT7516/ADT7517/ADT7519

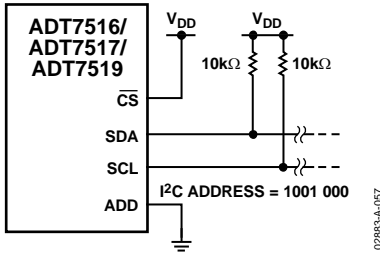

Figure 57. Typical I²C Interface Connection

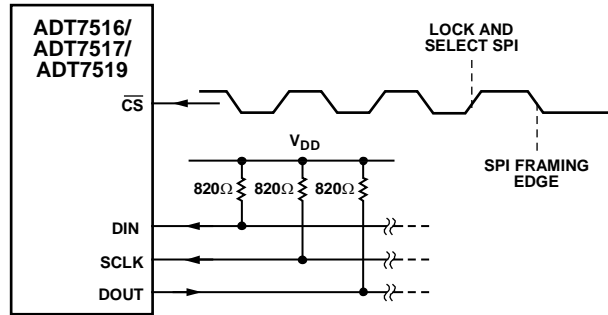

Figure 58. Typical SPI Interface Connection

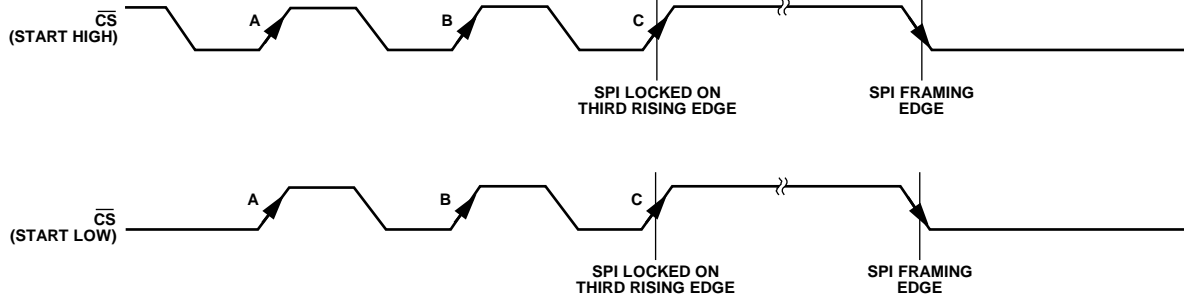

Figure 59. Serial Interface—Selecting and Locking SPI Protocol

I²C Serial Interface

Like all I²C compatible devices, the ADT7516/ADT7517/ADT7519 have a 7-bit serial address. The four MSBs of this address for the ADT7516/ADT7517/ADT7519 are set to 1001. The three LSBs are set by Pin 11, ADD. The ADD pin can be configured three ways to give three different address options: low, floating, and high. Setting the ADD pin low gives a serial bus address of 1001 000, leaving it floating gives the address 1001 010, and setting it high gives the address 1001 011. The recommended pull-up resistor value is 10 kΩ.

There is an enable/disable bit for the SMBus timeout. When this is enabled, the SMBus will time out after 25 ms of no activity. To enable it, set Bit 6 of the Control Configuration 2 register. The power-on default is with the SMBus timeout disabled.

The ADT7516/ADT7517/ADT7519 support SMBus packet error checking (PEC), but its use is optional. It is triggered by supplying the extra clocks for the PEC byte. The PEC is calculated using CRC-8. The frame clock sequence (FCS) conforms to CRC-8 by the polynomial

$$C(x) = x^8 + x^2 + x^1 + 1$$

Consult the SMBus specification (www.smbus.org) for more information.

The serial bus protocol operates as follows:

1. The master initiates a data transfer by establishing a start condition, defined as a high to low transition on the serial data line SDA while the serial clock line SCL remains high. This indicates that an address/data stream will follow. All slave peripherals connected to the serial bus respond to the start condition and shift in the next eight bits, consisting of

a 7-bit address (MSB first) plus a R/W bit, which determines the direction of the data transfer, i.e., whether data will be written to or read from the slave device.

The peripheral whose address corresponds to the transmitted address responds by pulling the data line low during the low period before the ninth clock pulse, known as the Acknowledge Bit. All other devices on the bus now remain idle while the selected device waits for data to be read from or written to it. If the R/W bit is 0 the master will write to the slave device. If the R/W bit is 1, the master will read from the slave device.

2. Data is sent over the serial bus in sequences of nine clock pulses: eight bits of data followed by an acknowledge bit from the receiver of data. Transitions on the data line must occur during the low period of the clock signal and remain stable during the high period, because a low to high transition when the clock is high may be interpreted as a stop signal.
3. When all data bytes have been read or written, stop conditions are established. In write mode, the master will pull the data line high during the 10th clock pulse to assert a stop condition. In read mode, the master device will pull the data line high during the low period before the ninth clock pulse. This is known as No Acknowledge. The master will then take the data line low during the low period before the 10th clock pulse, and then high during the 10th clock pulse to assert a stop condition.

Any number of bytes of data can be transferred over the serial bus in one operation, but it is not possible to mix read and write in one operation because the type of operation is determined at the beginning and cannot subsequently be changed without starting a new operation.

The I²C address set up by the ADD pin is not latched by the device until after this address has been sent twice. On the eighth SCL cycle of the second valid communication, the serial bus address is latched in. This is the SCL cycle directly after the device has seen its own I²C serial bus address. Any subsequent changes on this pin will have no effect on the I²C serial bus address.

Writing to the ADT7516/ADT7517/ADT7519

Depending on the register being written to, there are two different writes for the ADT7516/ADT7517/ADT7519. It is not possible to do a block write to this part, i.e., no I²C auto-increment.

Writing to the Address Pointer Register for a Subsequent Read

To read data from a particular register, the address pointer register must contain the address of that register. If it does not, the correct address must be written to the address pointer register by performing a single-byte write operation, as shown in Figure 60. The write operation consists of the serial bus address followed by the address pointer byte. No data is written to any of the data registers. A read operation is then performed to read the register.

Writing Data to a Register

All registers are 8-bit registers, so only one byte of data can be written to each register. Writing a single byte of data to one of these read/write registers consists of the serial bus address, the data register address written to the address pointer register, followed by the data byte written to the selected data register. This is illustrated in Figure 61. To write to a different register, another start or repeated start is required. If more than one byte of data is sent in one communication operation, the addressed

register will be repeatedly loaded until the last data byte has been sent.

Reading Data from the ADT7516/ADT7517/ADT7519

Reading data from the ADT7516/ADT7517/ADT7519 is done in a 1-byte operation. Reading back the contents of a register is shown in Figure 62. The register address had previously been set up by a single-byte write operation to the address pointer register. To read from another register, write to the address pointer register again to set up the relevant register address. Thus, block reads are not possible, i.e., no I²C auto-increment.

SPI Serial Interface

The SPI serial interface of the ADT7516/ADT7517/ADT7519 consists of four wires: CS, SCLK, DIN, and DOUT. The CS is used to select the device when more than one device is connected to the serial clock and data lines. The CS is also used to distinguish between any two separate serial communications (see Figure 67 for a graphical explanation). The SCLK is used to clock data in and out of the part. The DIN line is used to write to

the registers, and the DOUT line is used to read data back from the registers. The recommended pull-up resistor value is between 500 Ω and 820 Ω.

The part operates in slave mode and requires an externally applied serial clock to the SCLK input. The serial interface is designed to allow the part to be interfaced to systems that provide a serial clock that is synchronized to the serial data.

There are two types of serial operations, read and write. Command words are used to distinguish read operations from write operations. These command words are given in Table 67. Address auto-increment is possible in SPI mode.

Table 67. SPI Command Words

Write	Read
90h (1001 0000)	91h (1001 0001)

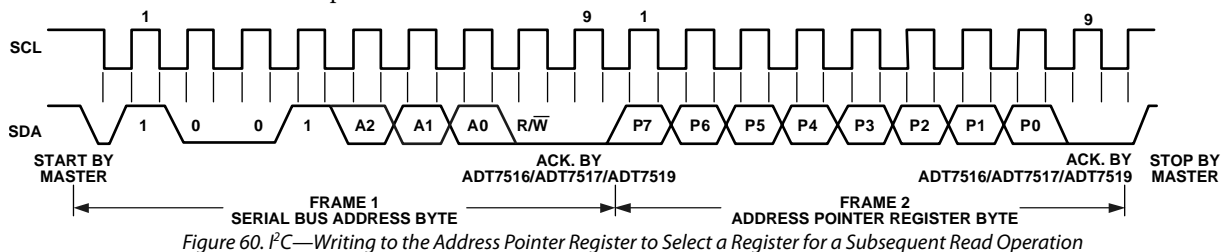

Figure 60. I²C—Writing to the Address Pointer Register to Select a Register for a Subsequent Read Operation

ADT7516/ADT7517/ADT7519

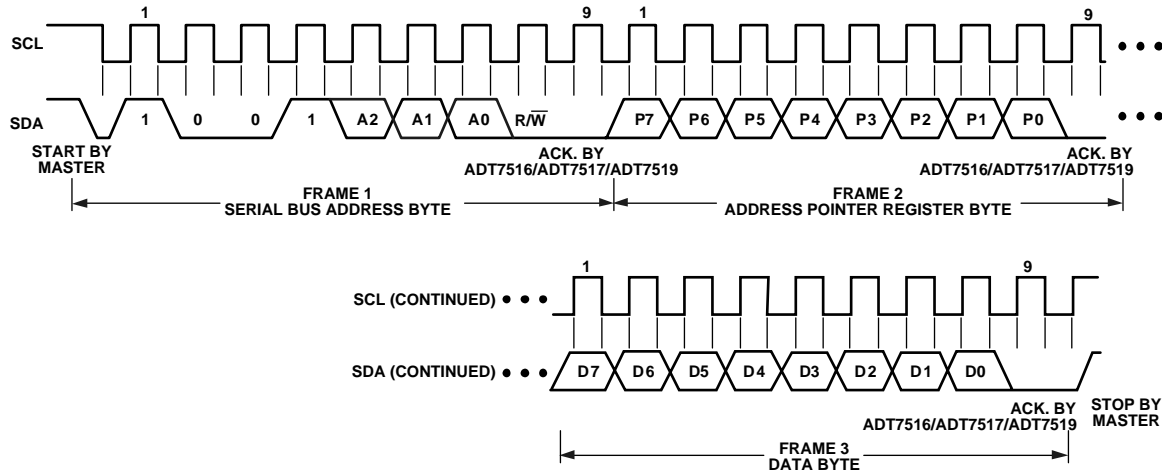

Figure 61. I²C—Writing to the Address Pointer Register Followed by a Single Byte of Data to the Selected Register

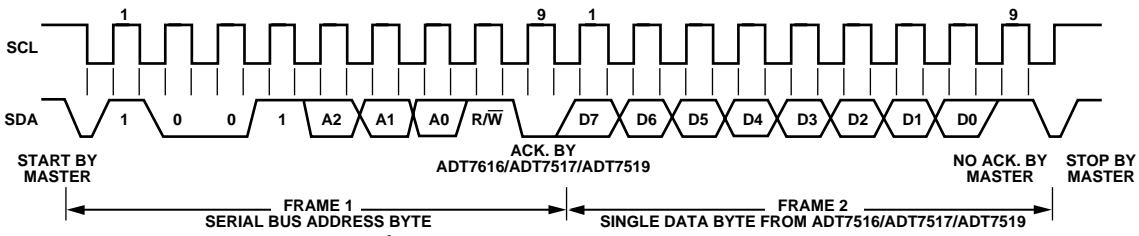

Figure 62. I²C—Reading a Single Byte of Data from a Selected Register

Write Operation

Figure 63 shows the timing diagram for a write operation to the ADT7516/ADT7517/ADT7519. Data is clocked into the registers on the rising edge of SCLK. When the \overline{CS} line is high, the DIN and DOUT lines are in three-state mode. Only when the \overline{CS} goes from a high to a low does the part accept any data on the DIN line. In SPI mode, the address pointer register is capable of auto-incrementing to the next register in the register map without having to load the address pointer register each time. In Figure 63, the register address portion gives the first register that will be written to. Subsequent data bytes will be written into sequential writable registers. Thus, after each data byte has been written into a register, the address pointer register auto-increments its value to the next available register. The address pointer register will auto-increment from 00h to 3Fh and will loop back to start again at 00h when it reaches 3Fh.

Read Operation

Figure 64 to Figure 66 show the timing diagrams necessary to accomplish correct read operations. To read back from a register, first write to the address pointer register with the address of the register to be read from. This operation is shown in Figure 64. Figure 65 shows the procedure for reading back a single byte of data. The read command is first sent to the part during the first eight clock cycles. During the following eight clock cycles, the data contained in the register selected by the address pointer register is output onto the D_{OUT} line. Data is output onto the D_{OUT} line on the falling edge of SCLK. Figure 66 shows the procedure when reading data from two sequential registers. Multiple data reads are possible in the SPI interface mode as the address pointer register is auto-incremental. The address pointer register will auto-increment from 00h to 3Fh and will loop back to start again at 00h when it reaches 3Fh.

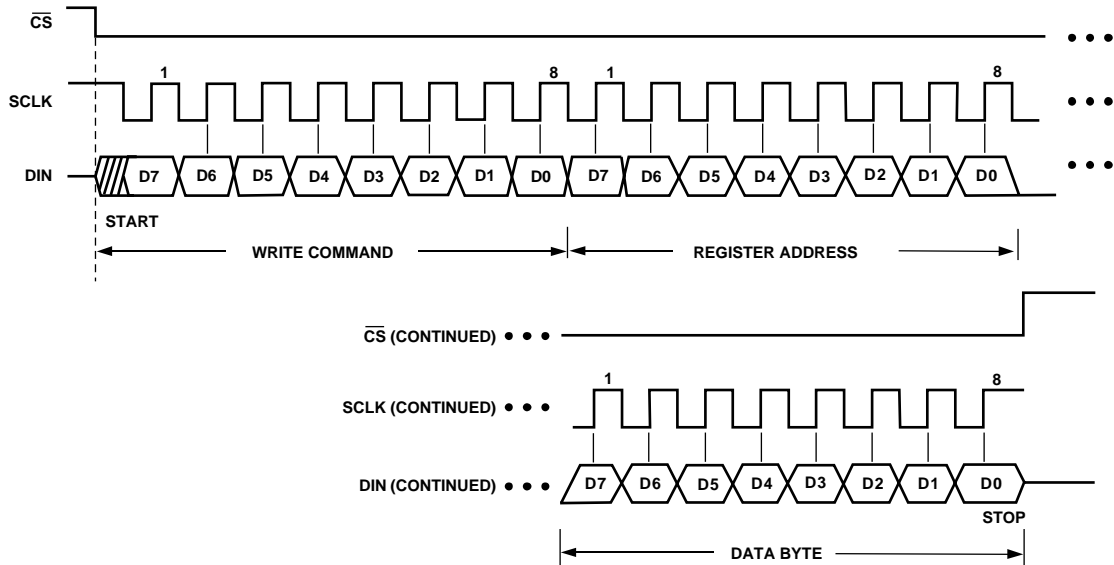

Figure 63. SPI—Writing to the Address Pointer Register Followed by a Single Byte of Data to the Selected Register

02883-A-062

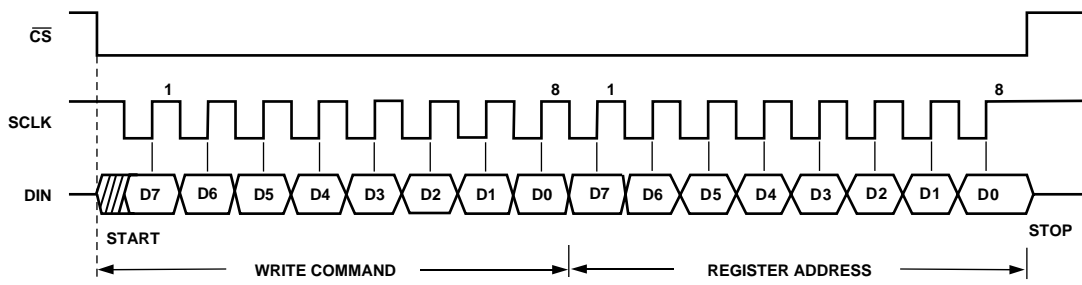

Figure 64. SPI—Writing to the Address Pointer Register to Select a Register for a Subsequent Read Operation

02883-A-063

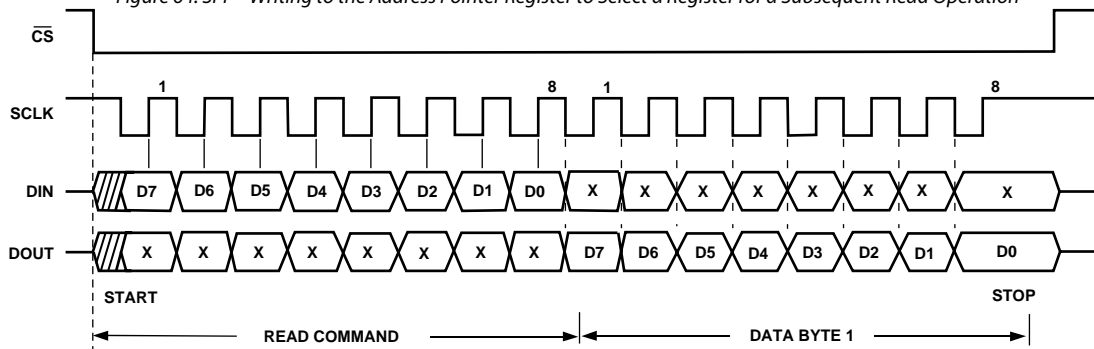

Figure 65. SPI—Reading a Single Byte of Data From a Selected Register

02883-A-064

ADT7516/ADT7517/ADT7519

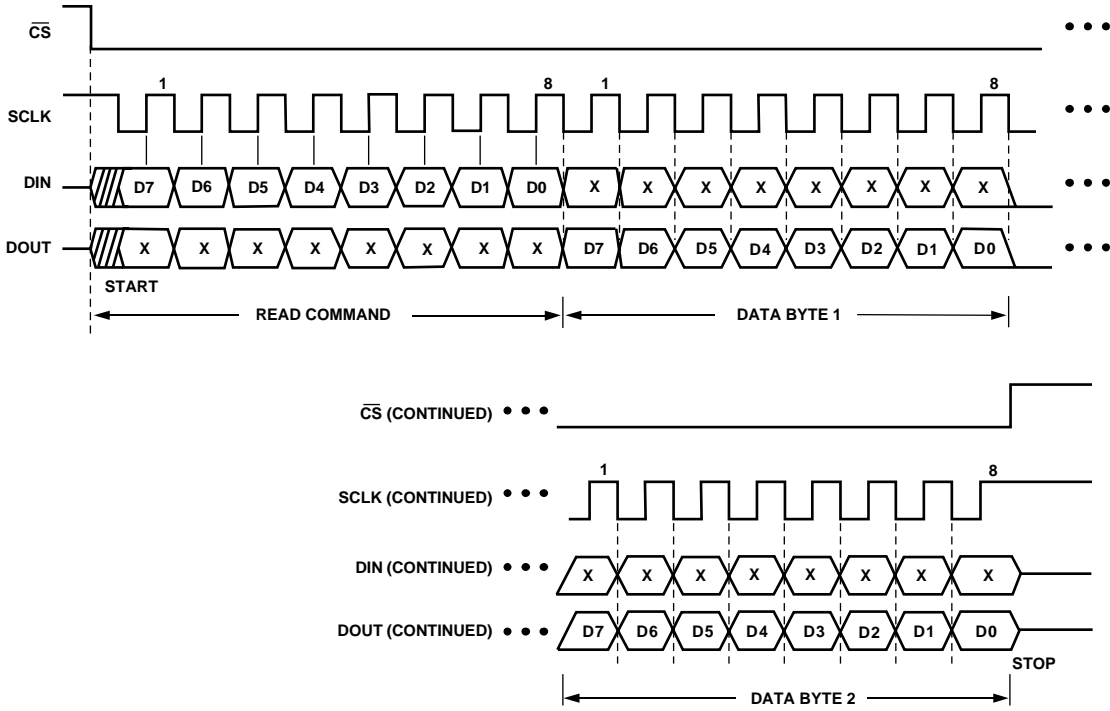

Figure 66. SPI—Reading Two Bytes of Data from Two Sequential Registers

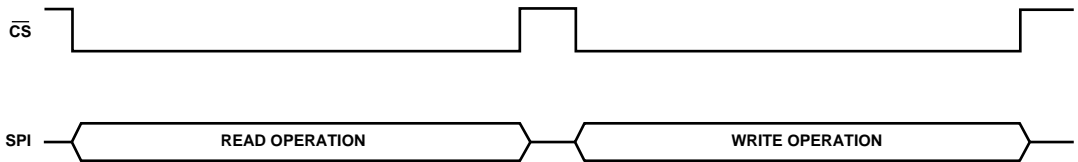

Figure 67. SPI—Correct Use of \overline{CS} during SPI Communication

02883-A-065

02883-A-066

SMBus/SPI INT/ $\overline{\text{INT}}$

The ADT7516/ADT7517/ADT7519 INT/ $\overline{\text{INT}}$ outputs are an interrupt line for devices that want to trade their ability to master for an extra pin. The ADT7516/ADT7517/ADT7519 are slave devices and use the SMBus/SPI INT/ $\overline{\text{INT}}$ to signal the host device that it wants to talk to. The SMBus/SPI INT/ $\overline{\text{INT}}$ on the ADT7516/ADT7517/ADT7519 is used as an over/under limit indicator.

The INT/ $\overline{\text{INT}}$ pin has an open-drain configuration that allows the outputs of several devices to be wired-AND together when the INT/ $\overline{\text{INT}}$ pin is active low. Use C6 of the Control Configuration 1 register to set the active polarity of the INT/ $\overline{\text{INT}}$ output. The power-up default is active low. The INT/ $\overline{\text{INT}}$ output can be disabled or enabled by setting C5 of the Control Configuration 1 register to 1 or 0, respectively.

The INT/ $\overline{\text{INT}}$ output becomes active when either the internal temperature value, the external temperature value, V_{DD} value, or any of the AIN input values exceed the values in their corresponding $T_{\text{HIGH}}/V_{\text{HIGH}}$ or $T_{\text{LOW}}/V_{\text{LOW}}$ registers. The INT/ $\overline{\text{INT}}$ output goes inactive again when a conversion result has the measured value back within the trip limits and when the status register associated with the out-of-limit event is read. The two interrupt status registers show which event caused the INT/ $\overline{\text{INT}}$ pin to go active.

The INT/ $\overline{\text{INT}}$ output requires an external pull-up resistor. This can be connected to a voltage different from V_{DD} , provided the maximum voltage rating of the INT/ $\overline{\text{INT}}$ output pin is not exceeded. The value of the pull-up resistor depends on the application but should be large enough to avoid excessive sink currents at the INT/ $\overline{\text{INT}}$ output, which can heat the chip and affect the temperature reading.

SMBUS ALERT RESPONSE

The INT/ $\overline{\text{INT}}$ pin behaves the same way as an SMBus alert pin when the SMBus/I²C interface is selected. It is an open-drain output and requires a pull-up to V_{DD} . Several INT/ $\overline{\text{INT}}$ outputs can be wire-AND together, so that the common line will go low if one or more of the INT/ $\overline{\text{INT}}$ outputs goes low. The polarity of the INT/ $\overline{\text{INT}}$ pin must be set active low for a number of outputs to be wired-AND together.

The INT/ $\overline{\text{INT}}$ output can operate as an SMBALERT function. Slave devices on the SMBus can not normally signal to the master that they want to talk, but the SMBALERT function allows them to do so. SMBALERT is used in conjunction with the SMBus general call address.

One or more INT/ $\overline{\text{INT}}$ outputs can be connected to a common SMBALERT line connected to the master. When the SMBALERT line is pulled low by one of the devices, the following procedure occurs as shown in Figure 68.

1. SMBALERT pulled low.
2. Master initiates a read operation and sends the alert response address (ARA = 0001 100). This is a general call address that must not be used as a specific device address.
3. The devices whose INT/ $\overline{\text{INT}}$ output is low responds to the alert response address and the master reads its device address. As the device address is seven bits long, an LSB of 1 is added. The address of the device is now known and it can be interrogated in the usual way.
4. If more than one device's INT/ $\overline{\text{INT}}$ output is low, the one with the lowest device address will have priority in accordance with normal SMBus specifications.
5. Once the ADT7516/ADT7517/ADT7519 have responded to the alert response address, they will reset their INT/ $\overline{\text{INT}}$ output, provided that the condition that caused the out-of-limit event no longer exists and that the status register associated with the out-of-limit event is read. If the SMBALERT line remains low, the master will send the ARA again. It will continue to do this until all devices whose SMBALERT outputs were low have responded.

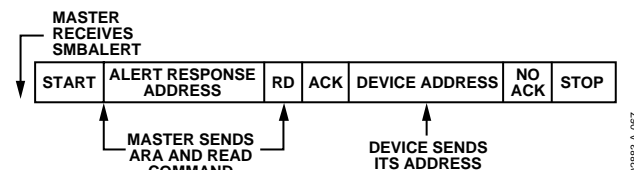

Figure 68. INT/ $\overline{\text{INT}}$ Responds to SMBALERT ARA

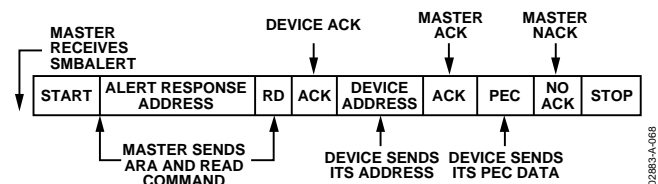
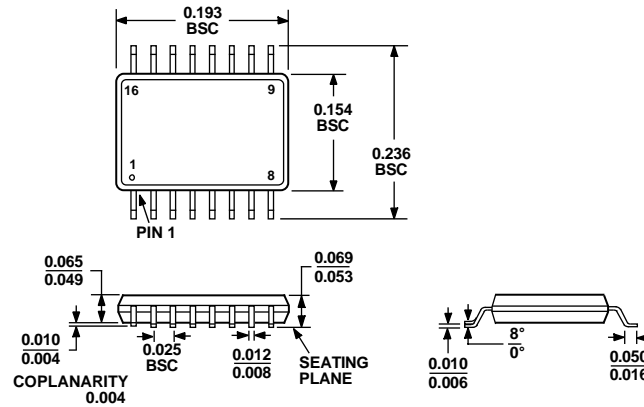

Figure 69. INT/ $\overline{\text{INT}}$ Responds to SMBALERT ARA with Packet Error Checking (PEC)

ADT7516/ADT7517/ADT7519

OUTLINE DIMENSIONS



COMPLIANT TO JEDEC STANDARDS MO-137AB

Figure 70. 16-Lead Shrink Small Outline Package [QSOP] (RQ-16)

Dimensions in Inches

ORDERING GUIDE

Model	Temperature Range	DAC Resolution	Package Description	Minimum Quantities/Reel
ADT7519ARQ	-40°C to +120°C	8 Bits	16-Lead QSOP	N/A
ADT7519ARQ-REEL	-40°C to +120°C	8 Bits	16-Lead QSOP	2500
ADT7519ARQ-REEL7	-40°C to +120°C	8 Bits	16-Lead QSOP	1000
ADT7519ARQZ ¹	-40°C to +120°C	8 Bits	16-Lead QSOP	N/A
ADT7519ARQZ ¹ -REEL	-40°C to +120°C	8 Bits	16-Lead QSOP	2500
ADT7519ARQZ ¹ -REEL7	-40°C to +120°C	8 Bits	16-Lead QSOP	1000
ADT7517ARQ	-40°C to +120°C	10 Bits	16-Lead QSOP	N/A
ADT7517ARQ-REEL	-40°C to +120°C	10 Bits	16-Lead QSOP	2500
ADT7517ARQ-REEL7	-40°C to +120°C	10 Bits	16-Lead QSOP	1000
ADT7516ARQ	-40°C to +120°C	12 Bits	16-Lead QSOP	N/A
ADT7516ARQ-REEL	-40°C to +120°C	12 Bits	16-Lead QSOP	2500
ADT7516ARQ-REEL7	-40°C to +120°C	12 Bits	16-Lead QSOP	1000

¹ Z = Pb-free part.

Purchase of licensed I²C components of Analog Devices or one of its sublicensed Associated Companies conveys a license for the purchaser under the Philips I²C Patent Rights to use these components in an I²C system, provided that the system conforms to the I²C Standard Specification as defined by Philips.