

PLEASE CHECK WWW.MOLEX.COM FOR LATEST PART INFORMATION

Part Number: [0930703003](#)
Status: **Active**
Overview: rast_25_connector_system
Description: 2.50mm (.098") Pitch Appli-Mate RAST 2.5 Header, Vertical, 9 Circuits, Glow Wire Compatible, with Latch, Positioning Keys C, D, E, L, & J, Voided Circuits 3, 5 & 8

Documents:

[3D Model](#) [RoHS Certificate of Compliance \(PDF\)](#)
[Drawing \(PDF\)](#)

Agency Certification

UL E29179

General

Product Family PCB Headers
 Series [93070](#)
 Application Wire-to-Board
 Overview [rast_25_connector_system](#)
 Product Name RAST 2.5

Physical

Breakaway No
 Circuits (Loaded) 9
 Circuits Detail 9
 Color - Resin Natural
 Durability (mating cycles max) 10
 First Mate / Last Break No
 Flammability 94V-0
 Glow-Wire Compliant Yes
 Guide to Mating Part No
 Keying to Mating Part None
 Lock to Mating Part Yes
 Material - Metal Brass
 Material - Plating Mating Tin
 Material - Plating Termination Tin
 Material - Resin Nylon
 Number of Rows 1
 Orientation Vertical
 PC Tail Length (in) 0.130 In
 PC Tail Length (mm) 3.30 mm
 PCB Locator Yes
 PCB Retention None
 PCB Thickness Recommended (in) 0.059 In
 PCB Thickness Recommended (mm) 1.50 mm
 Packaging Type Carton
 Pitch - Mating Interface (in) 0.098 In
 Pitch - Mating Interface (mm) 2.50 mm
 Polarized to PCB Yes
 Stackable No
 Surface Mount Compatible (SMC) No
 Temperature Range - Operating -20C TO +120C
 Termination Interface: Style Through Hole

Electrical

Current - Maximum per Contact 6A
 Voltage - Maximum 32V

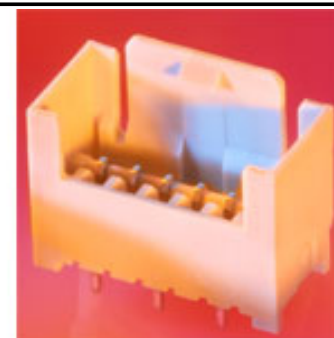

image - Reference only

Series

EU RoHS

ELV and RoHS Compliant
REACH SVHC Not Reviewed
Halogen-Free Status Not Reviewed

China RoHS



Need more information on product environmental compliance?

Email productcompliance@molex.com
 For a multiple part number RoHS Certificate of Compliance, [click here](#)

Please visit the [Contact Us](#) section for any non-product compliance questions.

Search Parts in this Series
[93070Series](#)

Material Info

Reference - Drawing Numbers

Packaging Specification

PK-93070-001

Sales Drawing

SD-93070-001

This document was generated on 06/08/2010

PLEASE CHECK WWW.MOLEX.COM FOR LATEST PART INFORMATION

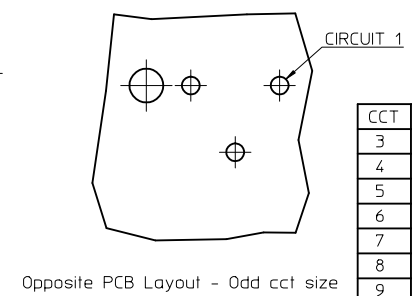
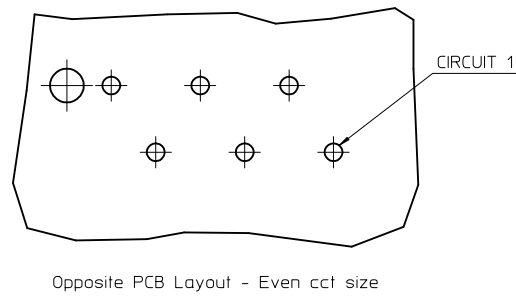
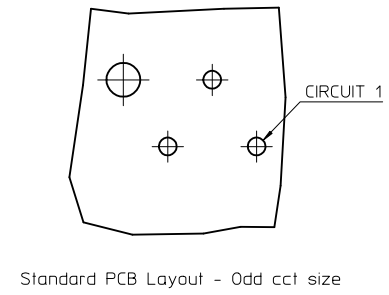
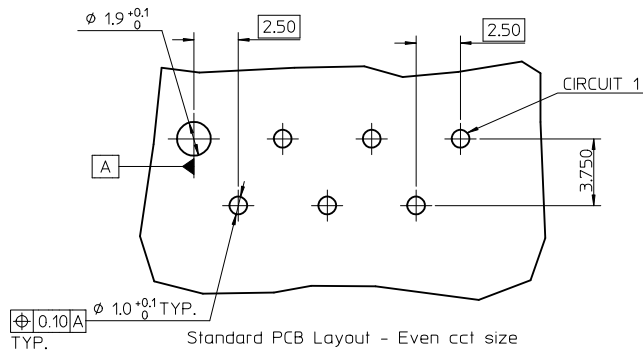
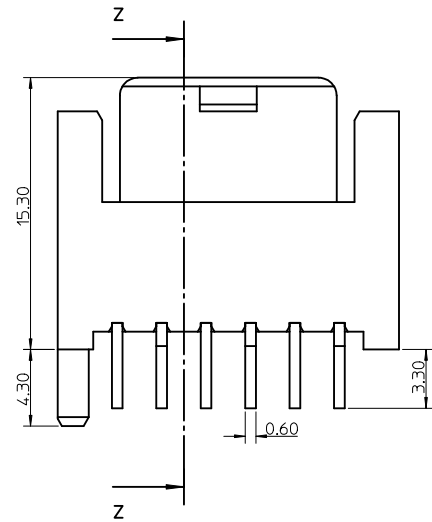
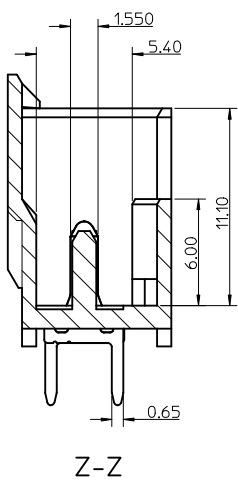
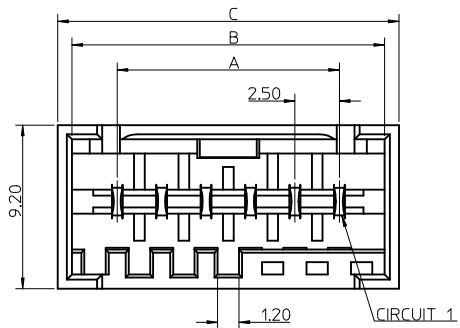

CCT	A	B	C
3	5.00	10.10	11.70
4	7.50	12.60	14.20
5	10.00	15.10	16.70
6	12.50	17.60	19.20
7	15.00	20.10	21.70
8	17.50	22.60	24.20
9	20.00	25.10	26.70
10	22.50	27.60	29.20
11	25.00	30.10	31.70
12	27.50	32.60	34.20
13	30.00	35.10	36.70
14	32.50	37.60	39.20
15	35.00	40.10	41.70

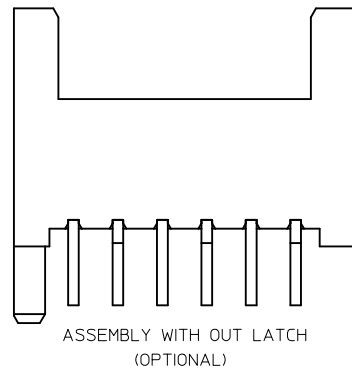

NOTES:

1. MATERIAL: HOUSING - PA66 25% G/F, UL94 V-0
COLOUR: NATURAL
TERMINAL - BRASS
PLATING - 3-7um Sn over 1.27um Min Ni
2. PARTS PACKED AS PER PK-90370-001
3. PRODUCT SPECIFICATION: PS-93070-001
4. RECOMMENDED PCB THICKNESS: 1.5+/-0.14mm

ADDED NEW P/NS EC NO: E2010-0255 DRAWN: TOURISH 2010/01/13 CHKD: BRITTLE 2010/01/19 APPR: BMAGUIRE 2010/01/19	QUALITY SYMBOLS ▽=0 ▽=0	GENERAL TOLERANCES (UNLESS SPECIFIED)		DIMENSION STYLE MM ONLY		SCALE 5:1	DESIGN UNITS METRIC	THIRD ANGLE PROJECTION
		4 PLACES ± ---	± ---	mm	INCH	DRAWN BY TOURISH	DATE 2008/03/14	TITLE RAST 2.5 APPLI-MATE VERTICAL MALE HEADER 2.5 PITCH
		3 PLACES ± 0.05	± ---			CHECKED BY BRITTLE	DATE 2008/03/14	MOLEX INCORPORATED
		2 PLACES ± 0.10	± ---			APPROVED BY BMAGUIRE	DATE 2008/03/14	
		1 PLACE ± 0.20	± ---			MATERIAL NO.		DOCUMENT NO. SD-93070-001
		ANGULAR ± 2 °				SEE SHEET 2&3		SHEET NO. 1 OF 3
		DRAFT WHERE APPLICABLE MUST REMAIN WITHIN DIMENSIONS				THIS DRAWING CONTAINS INFORMATION THAT IS PROPRIETARY TO MOLEX INCORPORATED AND SHOULD NOT BE USED WITHOUT WRITTEN PERMISSION		

3 CIRCUIT

MOLEX PART NO.	BLOCKED POSITION KEYS	TERMINAL VOID POSITION	CONFIGURATION	LATCH	CCT 1 LOCATION
93070-0001	NONE	NONE		YES	STANDARD
93070-0002	b d	NONE		YES	STANDARD
93070-0003	b c	NONE		YES	STANDARD
93070-0004	d	NONE		YES	STANDARD
93070-0005	a	NONE		YES	STANDARD
93070-0006	a b	NONE		YES	STANDARD
93070-0007	a c	NONE		YES	STANDARD
93070-0008	a d	NONE		YES	STANDARD
93070-0009	c d	NONE		YES	STANDARD
93070-0010	b	NONE		YES	STANDARD

4 CIRCUIT

MOLEX PART NO.	BLOCKED POSITION KEYS	TERMINAL VOID POSITION	CONFIGURATION	LATCH	CCT 1 LOCATION
93070-0501	NONE	NONE		YES	STANDARD
93070-0502	b c	NONE		YES	STANDARD
93070-0503	b c	CCT 4		YES	STANDARD
93070-0504	c d	NONE		YES	STANDARD
93070-0505	NONE	CCT 1		YES	STANDARD
93070-0601	b c	NONE		YES	OPPOSITE
93070-0506	b	NONE		YES	STANDARD
93070-0507	c	NONE		YES	STANDARD
93070-0508	d	NONE		YES	STANDARD
93070-0509	a c d	NONE		YES	STANDARD
93070-0510	b c d	NONE		YES	STANDARD

6 CIRCUIT

MOLEX PART NO.	BLOCKED POSITION KEYS	TERMINAL VOID POSITION	CONFIGURATION	LATCH	CCT 1 LOCATION
93070-1501	NONE	NONE		YES	STANDARD
93070-1502	d f	CCT 2, 5		YES	STANDARD
93070-1503	c e	NONE		YES	STANDARD
93070-1505	d f	NONE		YES	STANDARD
93070-1506	b d f	CCT 4, 5		YES	STANDARD
93070-1507	NONE	CCT 2		YES	STANDARD
93070-1508	c f	CCT 2		YES	STANDARD
93070-1509	d	NONE		YES	STANDARD
93070-1510	a b c e f	NONE		YES	STANDARD
93070-1511	e f	NONE		YES	STANDARD

5 CIRCUIT

MOLEX PART NO.	BLOCKED POSITION KEYS	TERMINAL VOID POSITION	CONFIGURATION	LATCH	CCT 1 LOCATION
93070-1001	NONE	NONE		YES	STANDARD
93070-1002	c d	NONE		YES	STANDARD
93070-1003	a d f	NONE		YES	STANDARD
93070-1101	NONE	NONE		YES	OPPOSITE
93070-1004	d	NONE		YES	STANDARD
93070-1005	a b e f	NONE		YES	STANDARD
93070-1006	b c d e	NONE		YES	STANDARD

NOTES:
 1. + DENOTES TERMINAL VOID POSITION
 ⊕ DENOTES TERMINAL LOADED POSITION

SEE SHEET 1 ELEC NO: E2010-0255 DRAWN: TOURISH 2010/01/13 CHKD: BRITTLE 2010/01/19 APPR: BMAGUIRE 2010/01/19	QUALITY SYMBOLS	GENERAL TOLERANCES (UNLESS SPECIFIED)	DIMENSION STYLE	SCALE	DESIGN UNITS	THIRD ANGLE PROJECTION
	$\nabla=0$ $\nabla=0$	mm INCH 4 PLACES ± --- ± --- 3 PLACES ± 0.05 ± --- 2 PLACES ± 0.10 ± --- 1 PLACE ± 0.20 ± --- ANGULAR ± 2°	MM ONLY DRAWN BY DATE TOURISH 2008/03/14 CHECKED BY DATE BRITTLE 2008/03/14 APPROVED BY DATE BMAGUIRE 2008/03/14	1:1	METRIC	
	DRAFT WHERE APPLICABLE MUST REMAIN WITHIN DIMENSIONS	SEE CHARTS MATERIAL NO. THIS DRAWING CONTAINS INFORMATION THAT IS PROPRIETARY TO MOLEX INCORPORATED AND SHOULD NOT BE USED WITHOUT WRITTEN PERMISSION	TITLE RAST 2.5 APPLI-MATE VERTICAL MALE HEADER 2.5 PITCH MOLEX INCORPORATED DOCUMENT NO. SD-93070-001	SHEET NO. 2 OF 3		

7 CIRCUIT

MOLEX PART NO.	BLOCKED POSITION KEYS	TERMINAL VOID POSITION	CONFIGURATION	LATCH	CCT 1 LOCATION
93070-2001	NONE	NONE		YES	STANDARD
93070-2002	a f	CCT 2, 6		YES	STANDARD
93070-2003	d g	CCT 4		YES	STANDARD
93070-2004	a e	CCT 4		YES	STANDARD
93070-2005	d f g	CCT 4		YES	STANDARD
93070-2006	a f	CCT 4		YES	STANDARD
93070-2007	a	NONE		YES	STANDARD
93070-2008	NONE	CCT 2		YES	STANDARD
93070-2009	a	CCT 4		YES	STANDARD
93070-2010	h	CCT 2		YES	STANDARD
93070-2011	b e g	NONE		YES	STANDARD

8 CIRCUIT

MOLEX PART NO.	BLOCKED POSITION KEYS	TERMINAL VOID POSITION	CONFIGURATION	LATCH	CCT 1 LOCATION
93070-2501	NONE	NONE		YES	STANDARD
93070-2502	c f h i	NONE		YES	STANDARD
93070-2503	b c d h i	CCT 4, 7		YES	STANDARD
93070-2601	NONE	CCT 4, 7		YES	OPPOSITE
93070-2504	b c d h i	NONE		YES	STANDARD

9 CIRCUIT

MOLEX PART NO.	BLOCKED POSITION KEYS	TERMINAL VOID POSITION	CONFIGURATION	LATCH	CCT 1 LOCATION
93070-3001	NONE	NONE		YES	STANDARD
93070-3002	ALL	CCT 2, 5, 8		YES	STANDARD
93070-3101	NONE	CCT 3, 5, 8		YES	OPPOSITE
93070-3003	c d e i j	CCT 3, 5, 8		YES	STANDARD
93070-3004	NONE	CCT 2, 5, 8		YES	STANDARD

10 CIRCUIT

MOLEX PART NO.	BLOCKED POSITION KEYS	TERMINAL VOID POSITION	CONFIGURATION	LATCH	CCT 1 LOCATION
93070-3501	NONE	NONE		YES	STANDARD
93070-3502	NONE	CCT 2, 5, 7, 9		YES	STANDARD
93070-3503	a b d e f g i j	NONE		YES	STANDARD

11 CIRCUIT

MOLEX PART NO.	BLOCKED POSITION KEYS	TERMINAL VOID POSITION	CONFIGURATION	LATCH	CCT 1 LOCATION
93070-4001	NONE	NONE		YES	STANDARD

12 CIRCUIT

MOLEX PART NO.	BLOCKED POSITION KEYS	TERMINAL VOID POSITION	CONFIGURATION	LATCH	CCT 1 LOCATION
93070-4501	NONE	NONE		YES	STANDARD
93070-4502	NONE	CCT 2, 5, 8, 11		YES	STANDARD

13 CIRCUIT

MOLEX PART NO.	BLOCKED POSITION KEYS	TERMINAL VOID POSITION	CONFIGURATION	LATCH	CCT 1 LOCATION
93070-5001	NONE	NONE		YES	STANDARD
93070-5002	NONE	CCT 4, 6, 8, 10, 12		YES	STANDARD

14 CIRCUIT

MOLEX PART NO.	BLOCKED POSITION KEYS	TERMINAL VOID POSITION	CONFIGURATION	LATCH	CCT 1 LOCATION
93070-5501	NONE	NONE		YES	STANDARD

15 CIRCUIT

MOLEX PART NO.	BLOCKED POSITION KEYS	TERMINAL VOID POSITION	CONFIGURATION	LATCH	CCT 1 LOCATION
93070-6001	NONE	NONE		YES	STANDARD
93070-6002	o p	CCT 4, 6, 8, 10, 12, 14		YES	STANDARD
93070-6003	a d g i j n o p	NONE		YES	STANDARD

NOTES:
 1. + DENOTES TERMINAL VOIDED POSITION
 ⊕ DENOTES TERMINAL LOADED POSITION

SEE SHEET 1 ELEC NO: E2010-0255 DRAWN BY: TOURISH CHKD BY: BRUTTLE APPR: BMAGUIRE	QUALITY SYMBOLS	GENERAL TOLERANCES (UNLESS SPECIFIED)	DIMENSION STYLE	SCALE	DESIGN UNITS	THIRD ANGLE PROJECTION
	$\nabla=0$ $\nabla=0$	mm INCH 4 PLACES ± --- ± --- 3 PLACES ± 0.05 ± --- 2 PLACES ± 0.10 ± --- 1 PLACE ± 0.20 ± --- ANGULAR ± 2°	MM ONLY DRAWN BY: TOURISH DATE: 2008/03/14 CHECKED BY: BRUTTLE DATE: 2008/03/14 APPROVED BY: BMAGUIRE DATE: 2008/03/14	1:1	METRIC	
	DRAFT WHERE APPLICABLE MUST REMAIN WITHIN DIMENSIONS	SEE CHARTS MATERIAL NO.	TITLE: RAST 2.5 APPLI-MATE VERTICAL MALE HEADER 2.5 PITCH MOLEX INCORPORATED DOCUMENT NO. SD-93070-001	SHEET NO. 3 OF 3		
	THIS DRAWING CONTAINS INFORMATION THAT IS PROPRIETARY TO MOLEX INCORPORATED AND SHOULD NOT BE USED WITHOUT WRITTEN PERMISSION					