

5W, AC/DC converter

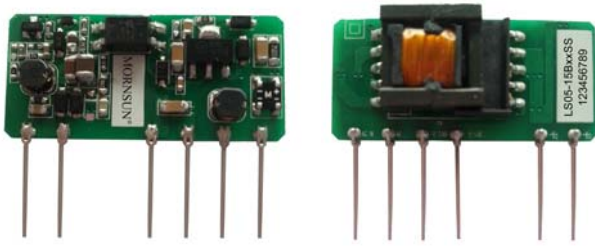

FEATURES

- Wide input voltage range: 85~264VAC/100~400VDC
- Over current protection and short circuit protection
- High efficiency, high safety isolation 3000VAC
- Urtal-slim SIP package
- Industrial grade
- Meet IEC60950, UL60950 and EN60950 standards
- UL60950, EN60950 approval
- 3 years of quality assurance

LS05-15BXXSS series is a high efficiency green power modules provided by Mornsun. The features of this series are: Accept either AC or DC input, wide input voltage, high efficiency, low loss, safety isolation etc. All models are particularly suitable for the applications such as industrial, electric power, instrumentation, smart home which do not have high requirement on EMC. EMC application circuit must be added if the products need to be applied to EMC harsh environment .

Selection Guide

Certification	Model	Output Power	Nominal Output Voltage and Current(Vo/Io)	Efficiency (230VAC, %/Typ.)	Max. Capacitive Load (uF)
UL/CE	LS05-15B03SS	3.3W	3.3V/1A	67	2200
	LS05-15B05SS		5V/1A	74	1500
	LS05-15B09SS		9V/0.56A	75	680
	LS05-15B12SS		12V/0.42A	76	470
	LS05-15B15SS		15V/0.34A	77	330
	LS05-15B24SS		24V/0.21A	79	100

Input Specifications

Item	Operating Conditions	Min.	Typ.	Max.	Unit
Input Voltage Range	Conventional	100	--	240	VAC
	AC input	85	--	264	
	DC input	100	--	400	VDC
Input frequency		47	--	63	Hz
Input current	115VAC	--	--	0.2	A
	230VAC	--	--	0.1	
Inrush current	115VAC	--	5	--	
	230VAC	--	10	--	
leakage Current	CY0 is InF/400VAC	--	--	0.25	mA

Output Specifications

Item	Operating Conditions	Min.	Typ.	Max.	Unit
Output Voltage Accuracy	LS05-15B03SS	--	±2	±3	%
	LS05-15B05/09/12/15/24SS	--	±1	±2	
Line Regulation	Full load	--	±0.1	±0.5	
Load Regulation	10%-100% load	--	±1	±1.5	
Output Ripple & Noise*	20MHz bandwidth (peak-peak value)	--	50	150	mV
Temperature Drift Coefficient		--	±0.02	--	%/°C
Stand-by Power Consumption		--	--	0.5	W
Short Circuit Protection		Continuous, self-recovery			
Over-current Protection		≥110%Io self-recovery			
Over-voltage Protection		Zener clamp diode			
Min. Load		0	--	--	%

Hold-up Time	115VAC input	--	20	--	ms
	230VAC input	--	80	--	

Note: *Ripple and Noise measuring refer to "ripple and noise measure figure", please see *AC-DC Converter Application Notes* for specific operation methods.

General Specifications

Item	Operating Conditions	Min.	Typ.	Max.	Unit	
Isolation Voltage	Input-output	Test time: 1min(leakage current setting value:5 mA)	3000	--	--	VAC
Operating Temperature		-25	--	+85	°C	
Storage Temperature		-40	--	+105		
Storage Humidity		--	--	85	%RH	
Welding Temperature	Wave-soldering	260±5°C; time:5~10s				
	Manual-welding	360±10°C; time:3~5s				
Switching Frequency		--	100	--	kHz	
Power Derating	-25°C~0°C	0.8	--	--	% / °C	
	+55°C~+85°C	1.33	--	--		
Safety Standard	IEC60950/EN60950/UL60950					
Safety-regulated Certification	EN60950/UL60950					
Safety Class	CLASS II					
Hot Plug	Unavailable					
MTBF	MIL-HDBK-217F@25°C > 300,000 h					

Physical Specifications

Package Dimensions	42.00*13.65*20.00mm
Weight	7 g(Typ.)
Cooling method	Free air convection

EMC Specifications

EMI	Conducted Disturbance	CISPR22/EN55022, CLASS A (See Fig. 1 for recommended circuit)		
		CISPR22/EN55022, CLASS B (See Fig. 2 for recommended circuit)		
	Radiated Emission	CISPR22/EN55022, CLASS B (See Fig. 1 or Fig. 2 for recommended circuit)		
EMS	Electrostatic Discharge	IEC/EN61000-4-2	contact ±4KV	Perf. Criteria B
	Radiation Immunity	IEC/EN61000-4-3	10V/m	perf. Criteria A
	EFT	IEC/EN61000-4-4 ±2KV (See Fig. 1 for recommended circuit)		perf. Criteria B
		IEC/EN61000-4-4 ±4KV (See Fig. 2 for recommended circuit)		perf. Criteria B
	Surge Immunity	IEC/EN61000-4-5 ±1KV/2KV (See Fig. 1 or Fig. 2 for recommended circuit)		perf. Criteria B
	Conducted Disturbance	IEC/EN61000-4-6 3 Vr.m.s(See Fig. 2 for recommended circuit)		perf. Criteria A
	Immunity for Power	IEC/EN61000-4-8 10A/m		perf. Criteria A
Immunities of voltage dip, drop and short interruption	IEC/EN61000-4-11 0%~70%		perf. Criteria B	

Product Characteristic Curve

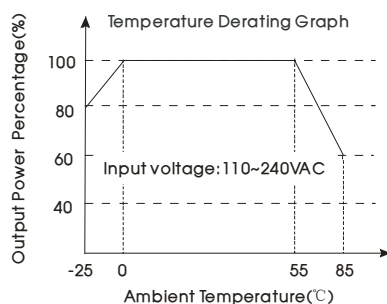

Note: Input voltage should be derated based on temperature derating when it is 85~110VAC /240~264VAC.

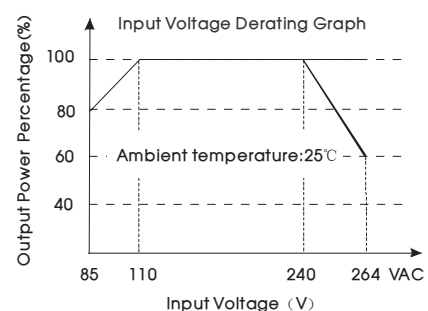

Note: When input DC, VDC=1.414VAC-20.

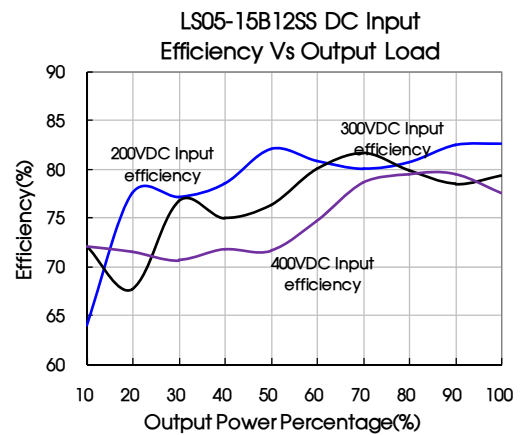
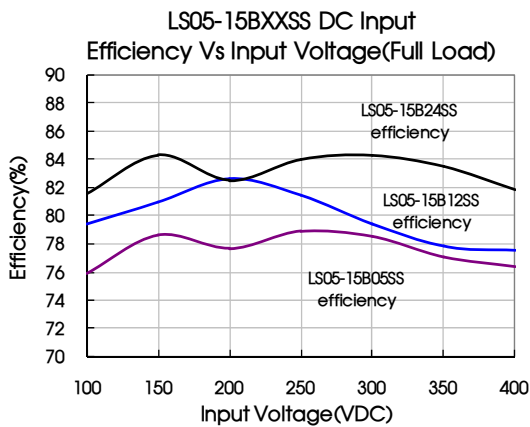
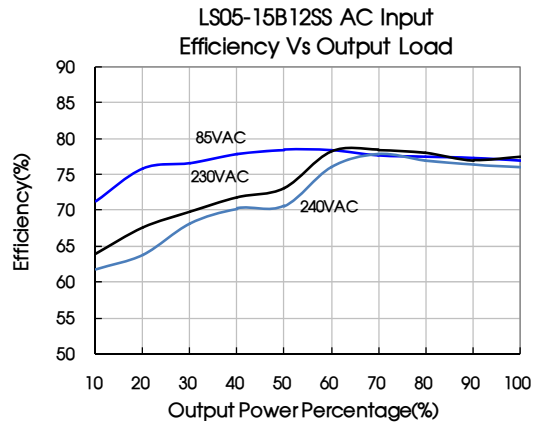
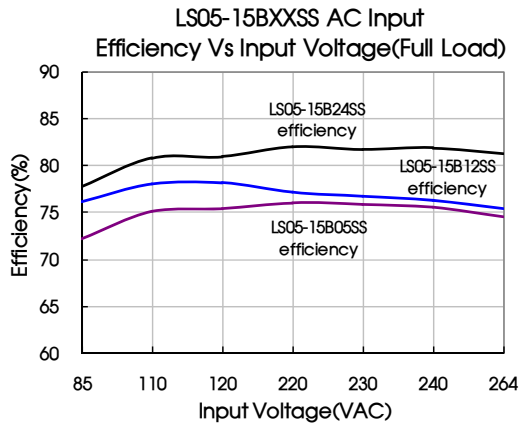

Design Reference

1. Typical application circuit

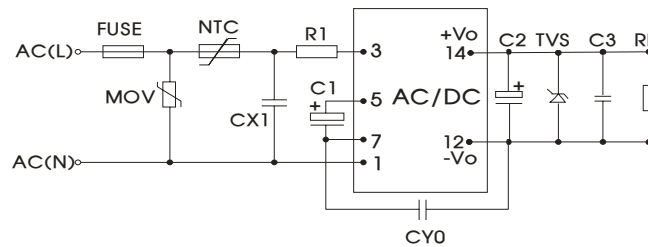

Fig. 1: Typical application circuit

Model	C1 (Required)	C2 (Required)	R1	C3	CX1	CY0	NTC	MOV	FUSE (Required)	TVS
LS05-15B03SS	10 μ F/400V	220 μ F/35V	12 Ω /2W	100nF/50V	0.1 μ F/275VAC	1nF/400VAC	13D-5	14D561K	1A/250V	SMBJ7.0A
LS05-15B05SS										SMBJ12A
LS05-15B09SS		150 μ F/35V								SMBJ20A
LS05-15B12SS										SMBJ20A
LS05-15B15SS										SMBJ20A
LS05-15B24SS	SMBJ30A									

- Note:
- C1: When AC input, C1 is used as filter capacitor, the value of C1 is recommended to be 10 μ F /400V. When DC input, C1 is used as EMC filter capacitor, the value of C1 is recommended to be 10 μ F/400V(when the input voltage is above 370VDC, the recommended value of C1 is 10 μ F/450V).
 - Output filtering capacitor C2 is electrolytic capacitor, C2 is recommended to apply electrolytic capacitor with high frequency and low resistance. For capacitance and current of capacitor please refer to manufacture's datasheet. Capacitance withstand voltage derating should be 80% or above. C3 is ceramic capacitor, which is used to filter high-frequency noise.

2. EMC solution-recommended circuit

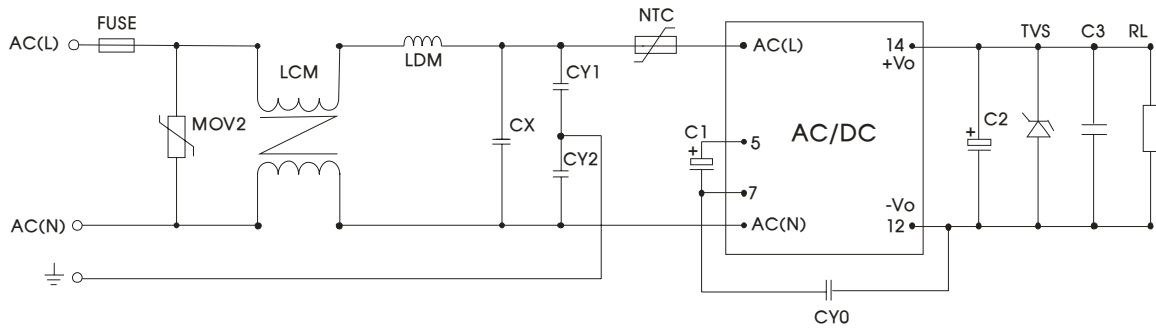

Fig 2: EMC application circuit with higher requirements

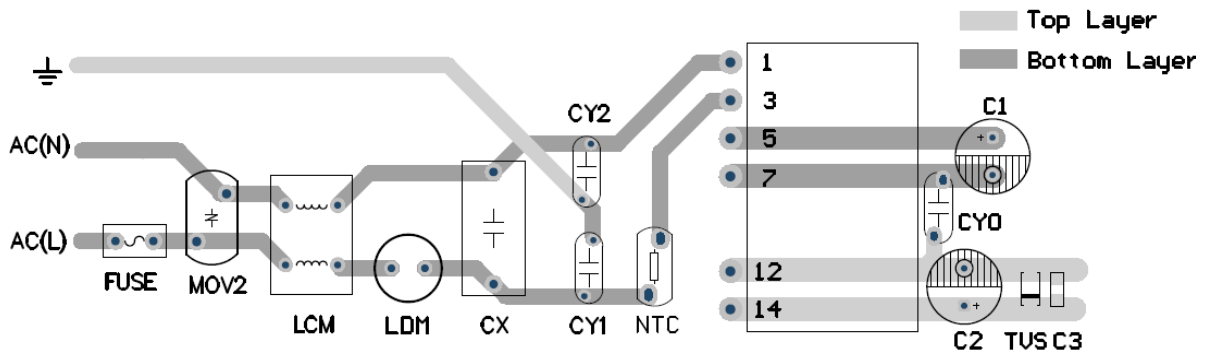

Fig 3: Recommended EMC circuit-PCB layout

Suggestions for safety regulation and wiring width: wire width $\geq 3\text{mm}$, distance between wires $\geq 6\text{mm}$, and distance between wire and ground $\geq 6\text{mm}$

Components	Recommend Parameter
MOV2	S14K320
CY1, CY2	1nF/400VAC
CX	0.1 μ F/275VAC
LCM	3.5mH
LDM	330 μ H
NTC	13D-5
FUSE	1A/250V, slow fusing, required

3. For more information please find application notes on www.mornsun-power.com

Dimensions and Recommended Layout

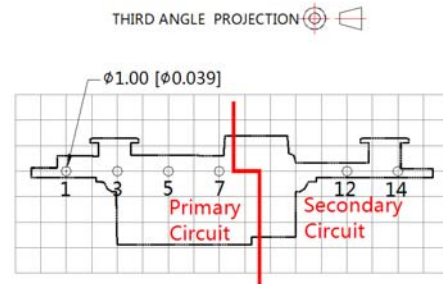
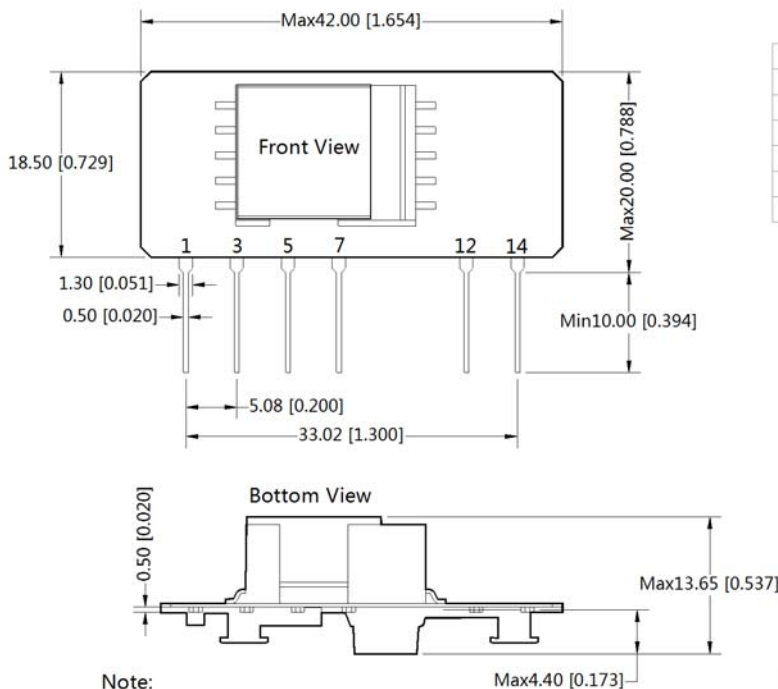

Note: Grid 2.54*2.54mm

Pin-Out	
Pin	Function
1	AC(N)
3	AC(L)
5	+V(cap)
7	-V(cap)
12	-Vo
14	+Vo

- 1.It is necessary to add C1 between pin5 and pin7.
- 2.It is necessary to add circuit to the output,such as the typical application of Figure 1.
- 3..It is needed to have distance $\geq 6.4\text{mm}$ for safety between external componets in primary circuit and secondary circuit.

Note:
Unit :mm[inch]
Pin section tolerances : $\pm 0.10[\pm 0.004]$
General tolerances: $\pm 0.50[\pm 0.020]$

- Note:
1. Packing Information please refer to 'Product Packing Information'. Packing bag number: 58230001;
 2. Module required dispensing fixed after assembled;
 3. This part is open frame, at least 6.4mm safety distance between the the primary and secondary external components of the module is needed to meet the safety requirement;
 4. All specifications were measured at $T_a=25^\circ\text{C}$, humidity<75%, nominal input voltage and rated output load unless otherwise specified;
 5. All index testing methods in this datasheet are based on our Company's corporate standards;
 6. The performance indexes of the product models listed in this manual are as above, but some indexes of non-standard model products will exceed the above-mentioned requirements, and please directly contact our technician for specific information;
 7. We can provide product customization service;
 8. Specifications of this product are subject to changes without prior notice.

Mornsun Guangzhou Science & Technology Co., Ltd.

Address: No. 5, Kehui St. 1, Kehui Development Center, Science Ave., Guangzhou Science City, Luogang District, Guangzhou, P. R. China
Tel: 86-20-38601850-8801 Fax: 86-20-38601272 E-mail: info@mornsun.cn