

User's Guide

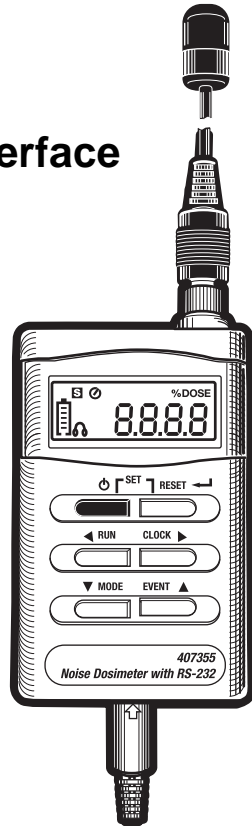

Noise Dosimeter with PC Interface

Model 407355



Introduction

Congratulations on your purchase of the Extech 407355 Personal Noise Dosimeter. The 407355 is designed to test noise exposure in accordance with OSHA, MSHA, DOD, ACGIH, and ISO standards. Fast and easy on-site surveys help determine noise reduction requirements. The meter can also be used in SLM (sound level meter) mode where sound pressure levels are monitored from 70 to 140dB. The SLM (sound level meter) mode has a datalogging feature that can record up to 8800 readings which can be downloaded to a PC for analysis. **Note:** In DOSIMETER mode, the individual measurements are NOT datalogged and cannot be recalled.

The built-in RS-232 PC interface offers the following capabilities:

- In SOUND LEVEL METER (SLM) MODE: The meter can be connected to PC while taking measurements so that readings can be stored in a file and readings can be viewed in a variety of display configurations (graph, list, etc.).
- In DOSIMETER mode: The meter can perform a noise survey after which the user can transfer the survey data to a PC.

Careful use of this device will provide years of reliable service.

Warranty

EXTECH INSTRUMENTS CORPORATION warrants this instrument to be free of defects in parts and workmanship for **one year** from date of shipment (a six month limited warranty applies to sensors and cables). If it should become necessary to return the instrument for service during or beyond the warranty period, contact the Customer Service Department at (781) 890-7440 ext. 210 for authorization or visit our website www.extech.com for contact information. A Return Authorization (RA) number must be issued before any product is returned to Extech. The sender is responsible for shipping charges, freight, insurance and proper packaging to prevent damage in transit. This warranty does not apply to defects resulting from action of the user such as misuse, improper wiring, operation outside of specification, improper maintenance or repair, or unauthorized modification. Extech specifically disclaims any implied warranties or merchantability or fitness for a specific purpose and will not be liable for any direct, indirect, incidental or consequential damages. Extech's total liability is limited to repair or replacement of the product. The warranty set forth above is inclusive and no other warranty, whether written or oral, is expressed or implied.

CE Certification



The CE-mark indicates compliance to the EMC directive

Safety

EN 61010-1 (1993) and IEC 1010-1 (1990); Safety requirements for electrical equipment for measurement, control, and laboratory use

EMC Emission

EN 50081-1 (1992): Generic emission standard

Part 1: Residential, commercial, and light industry

EN 50081-2 (1993): Generic emission standard

Part 2: Industrial environment

CISPR22 (1993): Radio disturbance characteristics of information technology equipment. Class B limits.

FCC rules, part 15: Complies with the limits for a Class B digital device

EMC Immunity

EN 50082-1 (1992): Generic immunity standard

Part 1: Residential, commercial, and light industry

RF immunity implies that sound level indications of 70dB or greater will be affected by no more than ± 1.5 dB

EN 50082-2 (1995): Generic immunity standard

Part 2: Industrial environment

RF immunity implies that sound level indications of 70dB or greater will be affected by no more than ± 1.5 dB

Specifications

Display	Multi-function LCD
Units of measure	dB A ('A' weighted decibels) for sound level % DOSE for accumulated noise exposure
Measurement ranges	70 to 140dB _A for sound level (SPL) measurements 0.01 to 9999 %DOSE for noise exposure surveys
Standards applied	ANSI S1.25-1991 A-weighting; ISO-1999; BS 6402: 1983
Criterion level	80, 84, 85, and 90dB (selectable)
Threshold level	70 to 90dB in 1dB steps (selectable)
Exchange rate	3, 4, 5, and 6dB (selectable)
High level detector	☉ appears on LCD when measurement exceeds 115dB _A
Peak flag	PK appears on LCD when measurement exceeds 140dB _A
Accuracy	±1.5dB
Frequency weighting	'A' weighting
Frequency response	31.5Hz to 8 kHz
Response time	F (FAST) and S (SLOW) selectable
Datalogging capacity	8800 sets
Operating Temperature	32 to 122°F (0 to 50°C)
Operating Humidity	10 to 90% RH
Storage Temperature	14 to 140°F (-10 to 60°C)
Storage Humidity	10 to 75% RH
Battery power	Four (4) 1.5V 'AAA' batteries
Battery life	40 hours (approx.)
Dimensions	4.2 (L) x 2.4 (W) x 1.3 (H)" 106 (L) x 60 (W) x 34 (H) mm
Weight	Approx. 12.3 oz. (350g) with batteries

Descriptions

Display Description

1. FAST Response Time mode
2. SLOW Response Time mode
3. Noise Exposure test active
4. Memory mode alert
5. Noise Exposure test paused
6. Unit of measure for Noise Exposure test
7. Battery Status Indicator
8. Event memory banks (E1-E5)
9. 115dB limit (headphone) indicator
10. Numerical display digits
11. Unit of measure for sound level readings
12. 140dB PEAK indicator
13. Elapsed time mode for noise exposure tests

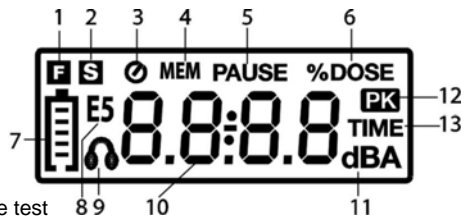



Meter Description

1. Microphone (lapel clip not shown)
2. Microphone cable
3. Microphone connector
4. LCD display
5. Push-buttons:

ON-OFF  Press to turn the meter ON; Press and hold to turn the meter OFF.

RESET  This button has a variety of uses including clearing stored data and accessing the Programming mode as described in the manual.

RUN  Press to begin a noise survey test in Dosimeter mode or datalogging in SLM mode. Also used as the Left Arrow in the Programming mode

CLOCK  Press to view the Date and Time. Also used as the Right Arrow in Programming mode

MODE  Press to select ELAPSED TIMER, SLM (dBA) mode, or noise survey (%DOSE) mode. Also used as the Down Arrow in the Programming mode

EVENT  Press to select a memory bank (E1 through E5). Also used as the Up Arrow in the Programming mode

6. RS-232 PC Interface plug
7. RS-232 PC Interface jack
8. Calibration potentiometer
9. Battery compartment screw
10. Belt clip / Battery compartment cover
11. Battery compartment
12. Microphone jack
13. Housing screws (service personnel only)

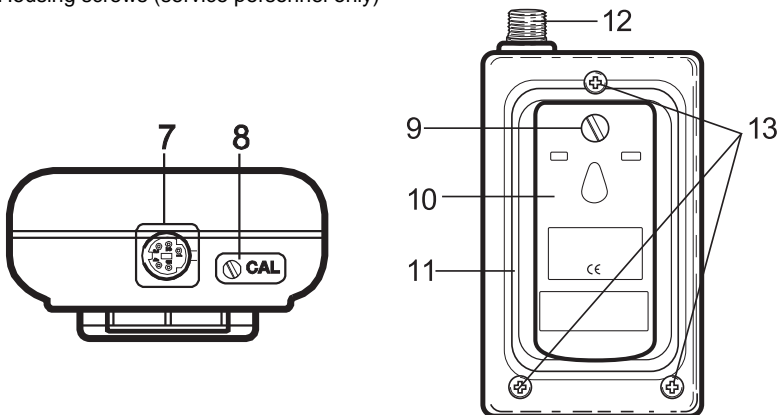
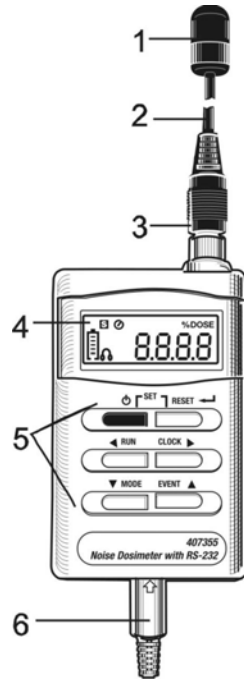

Operation

Getting Started

1. Power the instrument by pressing the green  button.
2. When the unit is turned on, all display annunciators switch on briefly followed by 'dDOSE', the Criterion Level (Lc), Threshold Level (Lt), and Exchange Rate (ER) respectively. These parameters are defined in the Noise Exposure related sections of this manual.
3. If the meter does not switch on when the power button is pressed, check that the batteries are installed and are fresh. Refer to the Battery Replacement section of this manual.
4. To turn the meter OFF, press and hold the green power button; the display will count down from 3dB to 0dB and then switch off.
5. The 407355 can be used as a Sound Level Meter or a Dosimeter.

Sound Level Meter Operation (dBA)

Press the MODE button repeatedly until the unit of measure is dBA (A-weighted decibels). In SLM mode the meter operates as a Type 2 sound level meter. The 407355 measures and displays sound pressure levels from 70 to 140dB. Read the measured sound level on the LCD. For Sound Level measurements < 68dBA the LCD will display dashed lines. For readings > 115dBA, the headphone  icon appears. For readings > 140dBA, the Peak Detector **PK** icon appears.

Datalogging

In Sound Level Meter (dBA) mode, the internal memory of the meter can store up to 8800 readings. Press the RUN key to start recording the measured readings. The **MEM** icon will appear in the display. To stop datalogging, press the RUN key again. The **MEM** icon will no longer be displayed on the screen. To download the data to a PC, refer to the PC Interface section in this manual.

Note: If the low battery mark is flashing or Dosimeter surveys E1 through E5 have been saved in memory, the datalogging function will not operate. The memory must be cleared. To clear memory, turn the meter off then hold down the RUN key and turn the meter on. **E-EP** will appear in the display to indicate that all memory data has been cleared.

Dosimeter Operation (Accumulated Noise Exposure - %DOSE)

1. Program the Response Time (Fast or Slow), Criterion Level (Lc), Exchange Rate (ER), and Threshold Level (Lt) manually (see Programming section) or through the supplied software (see PC Interface section).
2. Use the MODE button to select %DOSE as the unit of measure.
3. Select an unused Event Bank (E1 through E5) using the EVENT button.
4. Attach the meter to the user's belt buckle, breast pocket, or where convenient
5. Clip the microphone as close as possible to the user's ear (shirt collar, for example) using the lapel clip.
6. Route the cable as to not hinder the working movements of the user.
7. Press the RUN button to begin measuring accumulated noise exposure. The Clock display icon will switch on.
8. Press the RUN button momentarily to PAUSE the test (PAUSE display icon will switch on). Press the RUN button again to resume the test (PAUSE icon will switch off).

9. Use the MODE button at any time to view the elapsed time of the test. Press the MODE button until the TIME display icon appears. Now the elapsed time will appear in hours and minutes. Press the RUN button again to return to the %DOSE display.
10. To end the noise survey, press and hold the RUN key for 3 seconds. Read the accumulated noise exposure value on the LCD.
11. Testing notes:
 - Never shout into the microphone as this will affect the test.
 - To obtain reliable data, the user's activities must reflect a typical working day.
 - For best results, test over the course of several days and average the %DOSE

Refer to the dosimetry parameter descriptions below:

Event Select

Press the EVENT button to enter the EVENT mode. Each time the EVENT button is pressed the LCD increments the Event bank (E1 through E5). Each bank is a memory location. The user can store (or write over) the data in any of these locations. Each bank location (E1, for example) is displayed on the LCD along with the stored data. If data is present in a bank, the bank ID blinks. To erase data in a bank, press and hold the RESET button until the display ID stops blinking.

% DOSE

The unit of measure, % DOSE, is used to quantify noise exposure measured during a work shift. 100% dose is the maximum allowable noise exposure in accordance with OSHA, MSHA, DOD, ACGIH, and ISO standards. Most standards specify Criterion Level, Exchange Rate, Response Time, and Frequency weighting for the dosimeter as discussed next.

CRITERION LEVEL (Lc)

To take an on-site noise exposure survey in accordance with standards such as OSHA and MSHA, the dosimeter's Criterion Level must first be set. The 100% DOSE parameter discussed above is determined by the following equation: $100\% \text{ DOSE} = \text{Criterion Level for 8 hours}$. Each country has a unique Criterion Level (most countries, including the U.S., use 90dB). The Criterion level is selectable (80, 84, 85, or 90dB). Select the appropriate level per the Programming section of this manual.

EXCHANGE RATE (ER)

Exchange rate is best illustrated by example; refer to the following example: Since $100\% \text{ DOSE} = \text{Criterion Level for 8 hours}$, a person would receive 50% DOSE in 4 hours if the noise level equals the Criterion Level setting. Now consider a Criterion Level of 90dB, a noise measurement of 95dB (5dBA higher than the Criterion Level), and an Exchange Rate of 5dB; in this example a 100% DOSE would be received in only 4 hours. This is because with a 5dB Exchange Rate, a 5dB increase in sound level is considered a doubling of the DOSE. Other Exchange Rates can be selected (3, 4, 5, or 6dB). Refer to the local regulations or standards.

FAST (F) SLOW (S) RESPONSE TIME

Set the response time to Fast (F) to capture quick bursts of sound such as discharging firearms, fireworks, hammering, and other impulse noises. Use the Slow (S) setting if the noise under test is more of a continuous drone or background din. The Slow setting is typically specified by OSHA and MSHA standards for use in noise surveys. Refer to the Programming section of this manual to set the response time.

THRESHOLD LEVEL (Lt)

The threshold level is the sound level at which the 407354 begins to integrate noise into the exposure test. For example, if the threshold level (Lt) is set to 85dB, the meter will integrate all noise that equals or exceeds 85 dB. Sound levels below this threshold would not be included in the dose calculation. See the Programming section to change the level. The Threshold Level can be set from 70 to 90dB in 1 dB steps.

PEAK FLAG

When sound levels above 140dB are present the meter displays the **PK** symbol

HIGH LEVEL INDICATOR

When sound levels above 115dB are present the meter displays the headphone  symbol

Real Time Clock

Press the CLOCK key to display the current Day and Time accompanied by the TIME icon blinking. Note that the DATE and TIME settings are saved when the meter is turned off. To set the TIME and DATE refer to the Programming section.

Manual Programming

NOTE: The meter can be automatically programmed using the supplied software. Refer to the PC interface sections for details. Specifically, the OCCUPATIONAL NOISE EXPOSURE STANDARD software window can be used to configure the meter with one click of the mouse. To *Manually* Program the meter, follow these steps:

1. To access the programming mode, start with the 407355 power off.
2. Press and hold the ◀ (RESET) button while turning the instrument on.
3. Release the RESET button when **SEP (Setting Parameters)** appears.
4. Use the left ◀ and right ▶ arrow buttons to select the desired parameter
5. Use the up ▲ and down ▼ arrow buttons to change a parameter's setting
6. Refer to the parameter display symbols and their definitions below. These parameters are discussed throughout this manual

LC	(Criterion Level): 80, 84, 85, 90dB selections
LT	(Threshold Level): 70 to 90dB selectable in 1dB steps
ER	(Exchange Rate): 3, 4, 5, and 6 dB selections
20	First two digits of calendar year
04	Last two digits of calendar year
0_7_	Calendar Month
0_8_	Day of the Month
0_3_	Hour of the day
37	Minutes
S F	Slow (1 second) and Fast (125ms) response time settings

7. Press the ◀ button to exit the programming mode. Changes made in the programming mode will be saved upon exiting. Note that settings are not lost when the meter is turned off.

Calibration Procedure

Note that an acoustical calibrator (such as the Extech 407744 or 407766) is required to calibrate the 407355. Extech Instruments can also calibrate the instrument and provide an N.I.S.T. certificate if desired.

1. Set the instrument to the Sound Level Measurement Mode (dBA) using the MODE button.
2. Set the response time to SLOW (see the Programming section)
3. Insert the 407355 microphone into the microphone cavity of the calibrator.
4. Turn the calibrator ON and adjust the CAL screw on the 407355 so that the LCD display matches the calibrator output signal (94dB typically).
5. Calibration should be performed before each use.

PC Interface

Connecting the meter to the PC via the supplied interface cable

Connect the 5-pin end of the supplied interface cable to the DOSE Meter. Connect the 9-pin connector end of the cable to the PC COM Port. Cable and adaptor wiring are detailed later in this manual for reference.

Installing the supplied DOSE Windows™ Software

1. Insert the supplied software CD in the PC CD-ROM drive.
2. Follow the on-screen instructions for installation of the DOSE software program.
3. Open the DOSE program from the location where it is installed on the PC.

PC Interface Operational Modes

The PC Interface for the Model 407355 is used for both the Sound Level Meter (SLM) and the Noise Exposures Survey modes of meter operation:

- Sound Level Meter (SLM): There are 2 modes, Data Acquisition and Datalogging. In 'Data Acquisition' mode, the meter is connected to the PC and used as a Sound Level Meter. The PC captures the SLM readings (0.2 to 60 sec. sampling time), displays them in a variety of formats, and saves them to a file. In 'Datalogging' mode, the meter is used to capture up to 8800 readings in its internal memory (0.1 to 6553 sec. sampling time). The meter is disconnected from the PC while this function is performed. After the readings are captured, the meter is connected to the PC and the data is transferred from meter to PC.
- Noise Exposure Survey mode: In this mode, the meter is used normally as a Noise Survey Dosimeter. The meter is disconnected from the PC while the noise survey is performed. After the survey, the meter is connected to the PC and survey data is transferred from meter to PC.

Each mode is discussed below:

Sound Level Meter (SLM) Data Acquisition mode

1. Connect the meter to the PC using the supplied interface cable.
2. Run the DOSE software program.
3. Use the meter in the SLM mode as described previously.
4. Use the MAIN SOFTWARE and CONTROL PANEL windows to operate the meter, view the readings, and save the data file. The MAIN and the CONTROL PANEL windows are described in the Software Reference section.

Sound Level Meter (SLM) Datalogging mode

1. Perform a Datalogging operation as described previously.
2. After the test, connect the meter to the PC.
3. Run the DOSE software program.
4. Click the MEMORY tab in the MAIN software window. The MEMORY window will open and the readings will be copied from the meter to the PC.
5. After the data is downloaded, the Recorded Sets will be listed. Click an individual set and a detailed view of the data will appear.

Note: Datalogging sampling time can be set from 0.1 to 6553 seconds. Click in the Interval window, enter a time, and press the Return Key to accept the sampling time.

Noise Exposure Survey Data transfer to PC

1. Perform a Noise Survey as described previously.
2. After the test, connect the meter to the PC.
3. Run the DOSE software program.
4. Click the EVENT tab in the MAIN software window. The EVENT window will open as shown in the Software Reference section.
5. Click on the BANK tab in the EVENT window and select an individual bank (E1, E2, E3, E4, or E5) or all of the banks (E1-E5). The data will appear in the relevant bank column in the EVENT window. Alternatively, the user can click on the column of the Bank in order to download the noise survey results for a particular memory bank (E1 through E5).

Software Reference Information

The REMOTE CONTROL and MAIN SOFTWARE Windows

When the DOSE program is opened, two windows appear. The CONTROL PANEL window is used to remotely control the meter and to remotely view the meter's readings. Simply click on the meter's push-buttons in the CONTROL PANEL window. The MAIN SOFTWARE window has numerous functions and displays as detailed below.

Main Software Window

MENU Selections

Selection Buttons

Recording Interval

Response Time setting

Lowest reading logged

Current Criterion Level

Time of last reading

Current data file

Current reading

Current Exchange rate

Highest reading logged

Press to clear MIN MAX values

Current threshold setting

PC to Meter connection status

CONTROL PANEL WINDOW

MAIN Software Window Menu Headings

FILE

OPEN: Use an existing data file or create a new data file to store readings in SLM mode. Readings will be stored in this file when START RECORDING is selected.

START and STOP RECORDING: Start or Stop data recording in the currently opened file.

VIEW FILE: Open a previously stored data file on the PC and view the contents.

EXIT: Close the DOSE program

DISPLAY

This selection allows the user to view data in DATA ACQUISITION SLM MODE in LIST, GRAPH, ANALOG, or DIGITAL formats (see diagrams). The CONTROL PANEL can also be opened from this menu.

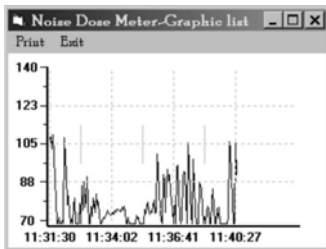
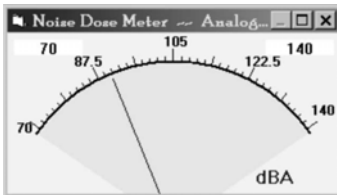

Noise Dose Meter-List

Print Exit

C.L.-criterion level E.R.-exchange rate
TWA-eight-hour time-weighted average sound level
You can change time interval by clicking the 'PC Sampling time' button.

Date	Time	Value	TWA	C.L.	Response	E.R.
07-08-2004	11:29:24.7	---	dB(A)			
07-08-2004	11:29:26.7	---	dB(A)			
07-08-2004	11:29:29.2	---	dB(A)			
07-08-2004	11:29:31.3	---	dB(A)			
07-08-2004	11:29:33.4	---	dB(A)			
07-08-2004	11:29:35.3	---	dB(A)			
07-08-2004	11:29:37.2	---	dB(A)			
07-08-2004	11:29:39.4	---	dB(A)			
07-08-2004	11:29:41.4	---	dB(A)			
07-08-2004	11:29:43.7	---	dB(A)			
07-08-2004	11:29:45.5	---	dB(A)			

Analog, Digital, Graph and List Display Modes

EVENT WINDOW - Download data from meter bank (E1 through E5) to PC

In this window the user can download, view, and save the contents of the meter's Event banks E1 through E5. Use the BANK tab to select one bank or all banks; this will automatically start a download operation. Alternatively, simply click on a column to initiate a download operation. The MENU headings are described below:

- FILE: Save the event data in a file
- BANK: Select one bank or all banks to initiate a download from meter to PC
- PRINT: Click to print the data to the local printer
- EXIT: Close the EVENT window

	E1	E2	E3	E4	E5
Used or not	Used	Unused	Unused	Unused	Unused
Criterion level	90dB				
Threshold level	80dB				
Exchange Rate	5dB				
Time Weighting	Slow				
115 dBRMS	No				
Exceed 140dB	No				
Start Date(mm:dd)	07-16				
Start Time(hh:mm)	09:55				
Stop Time(hh:mm)	10:12				
Exposure Time(hh:mm)	00:17				
Dose Value(%)	1.06				
TWA(8hr %Dose)	57.2				
PEAK FLAG TIME(hh:mm)					
PEAK DURATION(mm:ss)					

The Parameters shown in the left-most column of the EVENT window are explained below:

- USED OR NOT: Indicates that there are or are not data records in a particular bank. The word RECORDING will appear if the meter is currently performing a noise survey.
- Criterion, Threshold, Exchange, and Time weighting are the settings configured by the user for a noise survey as described previously.
- 115VdB RMS: Alerts the user that the sound level reached 115dB
- EXCEED 140dB: Alerts the user that the sound level reached 140dB
- START DATE and TIME: Date and time when noise survey began
- STOP TIME: Time of day noise survey ended
- EXPOSURE TIME: Duration of test
- DOSE VALUE: Dose value in percent for the period of the test
- TWA: Projected sound level in dB. In the example above, the elapsed time of the noise exposure test is only 17 minutes; much shorter than an 8-hour test. However, if sound levels remain relatively constant for the next 8 hours, the projected sound level average will be 57.2 dB.
- PEAK FLAG TIME: Time of day when sound level reached 115dB
- PEAK DURATION: Interval of time that sound level was equal to or greater than 115dB

AVERAGE

When AVERAGE is selected the window shown in the accompanying diagram opens. In the AVERAGE mode, the user selects a sampling interval and the software shows a value that represents the average of all the readings taken during the sampling interval.

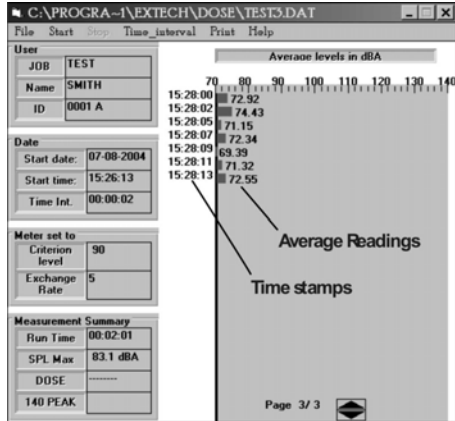

- The USER field can be used to personalize the data record (optional).
- The DATE field is automatically filled-in with the START DATE/TIME and the user-selected Time Interval (time between records).
- The METER SET TO field is automatically filled-in with the Criterion level and Exchange rate. If these fields do not automatically fill in, go to the EVENTS menu item and download the EVENT register information.
- The MEASUREMENT SUMMARY window automatically fills in when the test is stopped. The RUN TIME is total test time. The SPL MAX field is highest average reading taken during the course of the test. The DOSE field automatically fills in the %DOSE value for the test (in noise survey mode).

OPTION

TWA (Time Weighted Average) Information Window

TWA is the 8-hour projected average sound level in dB based on data collected from the start of the test up to the time the TWA is checked. See the information window below. TWA is automatically calculated in the EVENTS window, discussed previously.

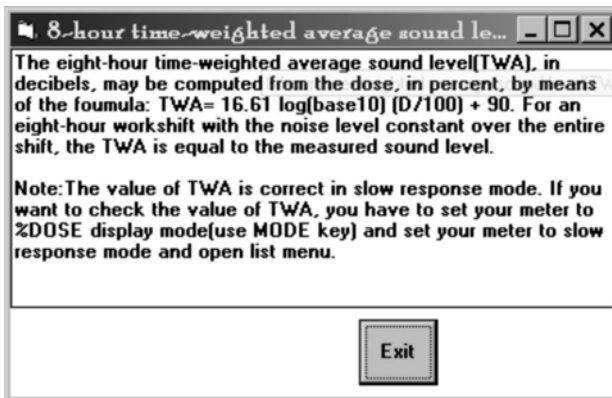

OCCUPATIONAL NOISE EXPOSURE STANDARD Window

The Occupational Noise Exposure Standard window (see diagram) is a convenient way to automatically set up the meter's noise survey parameters for a given country. Simply click on the desired country and then click the SET button. It may take a minute or so for the operation to complete.

Country	Criterion level dBA	Exposure time	Exchange Rate	MAX SPL	Peak SPL	Allowable/per day
Germany	90	8	-	-	-	-
France	90	40	-	-	-	-
Belgium	90	40	5	110	140	100
U.K	90	8	3	135	150	-
Ireland	90	-	-	-	-	-
Italy	90	8	5	115	140	-
Denmark	90	40	3	115	-	-
Sweden	85	40	3	115	-	-
U.S.A	90	8	5	115	140	100
Canada	90	8	5	115	140	-
Australia	90	8	3	115	-	-
Japan	85	8	3	-	-	-
Taiwan	90	8	5	115	140	-

SET MODE

The Set Mode is used to change the noise survey parameters and the Time/Date (see diagram). Select the desired settings and press the OK button when finished. It may take several minutes for the operation to complete.

Time Weighting
 Fast Slow

Criterion level
 80 84 85 90

Exchange rate
 3 4 5 6

Threshold Level
80
70 -90 and < C.L.

Date (computer system clock)
Year: 2004, Month: 07, Date: 13
Hour: 15, Minutes: 41

Buttons: Cancel, OK

PC Interface Cable and Adaptor Wiring Reference

The wiring diagrams and pin-outs for the supplied PC Interface cable is provided below:

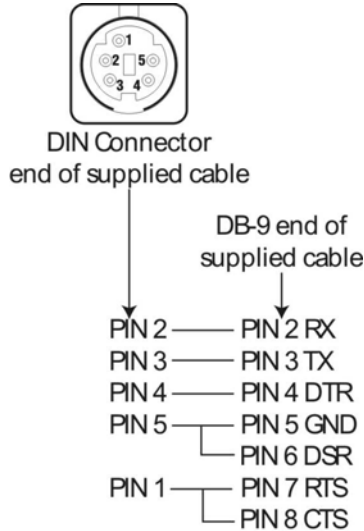

DIN to DB-9 Cable

Battery Replacement and Status Display

The 407355 is powered by four (4) 'AAA' 1.5V batteries and the LCD display employs a 5-segment battery status indicator.

5-segment battery LCD status indicator



When the batteries are fully charged, all five segments of the indicator will be visible. As the batteries discharge, the segments switch off one by one. Do not use the instrument if all five segments have switched off.

To replace the batteries:

1. Remove the large flat-head screw from the back of the instrument. This will free the belt clip; remove the clip.
2. The discharged 1.5V 'AAA' batteries will be visible behind the clip.
3. Replace the batteries observing polarity.
4. Re-assemble the clip

Conversion Charts

OSHA Permissible Noise Exposures

Duration per day, hours	Sound level dBA, slow response
8	90
6	92
4	95
3	97
2	100
1.5	102
1	105
0.5	110
0.25 or less	115

Source:29 CFR 1910 Table G-16

Conversion from Percent Noise Exposure or Dose to 8-Hour Time Weighted Average Sound Level(TWA)

Dose or percent	TWA (dBA)
50	85.0
55	85.7
60	86.3
65	86.9
70	87.4
75	87.9
80	88.4
85	88.8
90	89.2
95	89.6
100	90.0
105	90.4
110	90.7
115	91.1
120	91.3
125	91.6

Note: Assumes 5-dB exchange rate and 90-dBA Criterion

Calibration and Repair Services

Extech offers repair and calibration services for the products we sell. Extech also provides NIST certification for most products. Call the Customer Service Department for information on calibration services available for this product. Extech recommends that annual calibrations be performed to verify meter performance and accuracy.



Support line (781) 890-7440

Technical support: Extension 200; E-mail: support@extech.com

Repair & Returns: Extension 210; E-mail: repair@extech.com

Product specifications subject to change without notice

For the latest version of this User's Guide, Software updates, and other up-to-the-minute product information, visit our website: www.extech.com

Copyright © 2004 Extech Instruments Corporation

All rights reserved including the right of reproduction in whole or in part in any form.