

# Two-color chip LEDs with reflectors

## SML-020 Series

The SML-020 series are two-color, high luminance chip LEDs with reflectors. A red emitting chip and a green emitting chip are built into a single package. The compact and leadless design of these LEDs allows for high mounting density.

### ●Features

- 1) Reflectors are used to achieve a high luminance.
- 2) Two-color emission, rectangular and leadless (3 × 2.5 mm).
- 3) Can be mounted by automatic mounting.
- 4) Available on tape.

### ●External dimensions (Units: mm)

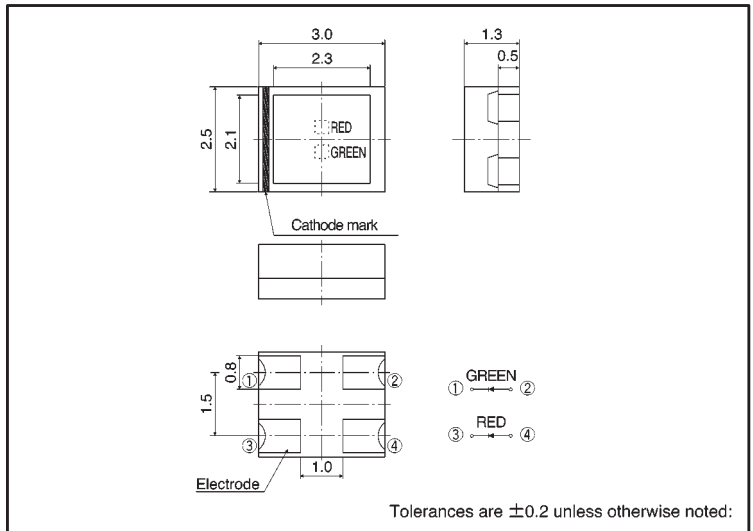

### ●Selection guide

| Emitting color    | Red<br>Green             |
|-------------------|--------------------------|
| Lens              |                          |
| Transparent clear | SML-020MVT<br>SML-020MLT |

### ●Absolute maximum ratings ( $T_a = 25^\circ\text{C}$ )

| Parameter             | Symbol         | Limits    |    | Unit             |
|-----------------------|----------------|-----------|----|------------------|
|                       |                | ML        | MV |                  |
| Power dissipation     | $P_D$          | 60        |    | mW               |
| Forward current       | $I_F$ Red      | 30        | 25 | mA               |
|                       | $I_F$ Green    | 25        |    |                  |
| Peak forward current  | $I_{FP}$ Red   | 75        | 60 | mA*              |
|                       | $I_{FP}$ Green | 60        |    |                  |
| Reverse voltage       | $V_R$          | 4         |    | V                |
| Operating temperature | $T_{opr}$      | -30 ~ +85 |    | $^\circ\text{C}$ |
| Storage temperature   | $T_{stg}$      | -40 ~ +85 |    | $^\circ\text{C}$ |

\* Pulse width 1ms Duty 1/5

●Electrical and optical characteristics (Ta = 25°C)

| Type       | Parameter | Color | Forward voltage    |      |                     | Reverse current     |                    | Luminous intensity   |      |                     | Peak wavelength |                     | Spectral line half width |                     |
|------------|-----------|-------|--------------------|------|---------------------|---------------------|--------------------|----------------------|------|---------------------|-----------------|---------------------|--------------------------|---------------------|
|            |           |       | V <sub>F</sub> (V) |      | Cond.               | I <sub>R</sub> (μA) | Cond.              | I <sub>v</sub> (mcd) |      | λ <sub>P</sub> (nm) | Cond.           | Δλ (nm)             | Cond.                    |                     |
|            |           |       | Typ.               | Max. | I <sub>F</sub> (mA) | Max.                | V <sub>R</sub> (V) | Min.                 | Typ. | I <sub>F</sub> (mA) | Typ.            | I <sub>F</sub> (mA) | Typ.                     | I <sub>F</sub> (mA) |
| SML-020MVT | V         | Red   | 2.0                | 2.8  | 20                  | 100                 | 4                  | 3.6                  | 6.3  | 20                  | 650             | 20                  | 40                       | 20                  |
|            | M         | Green | 2.2                | 2.8  | 20                  | 100                 | 4                  | 9.0                  | 20   | 20                  | 570             | 20                  | 40                       | 20                  |
| SML-020MLT | L         | Red   | 1.75               | 2.5  | 20                  | 100                 | 4                  | 9.0                  | 16   | 20                  | 660             | 20                  | 25                       | 20                  |
|            | M         | Green | 2.2                | 2.8  | 20                  | 100                 | 4                  | 9.0                  | 20   | 20                  | 570             | 20                  | 40                       | 20                  |

●Directional pattern

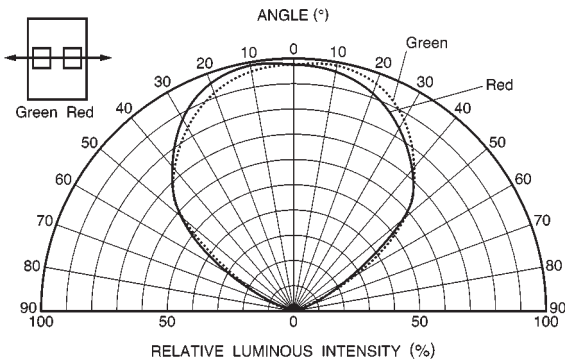

Fig. 1 Directional pattern (1)

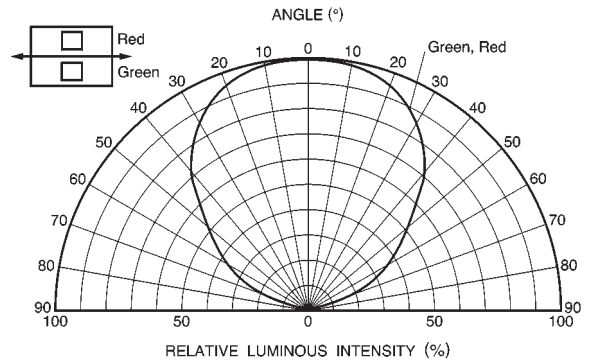

Fig. 2 Directional pattern (2)

●Electrical characteristic curves 1 (SML-020MVT)

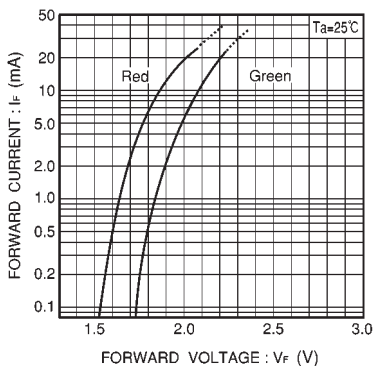

Fig. 3 Forward current vs. forward voltage

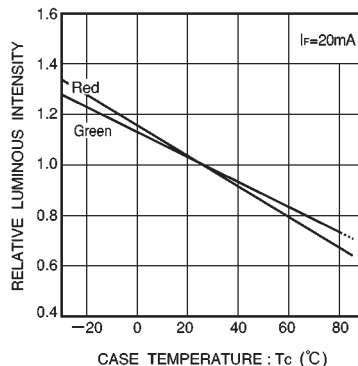

Fig. 4 Luminous intensity vs. case temperature

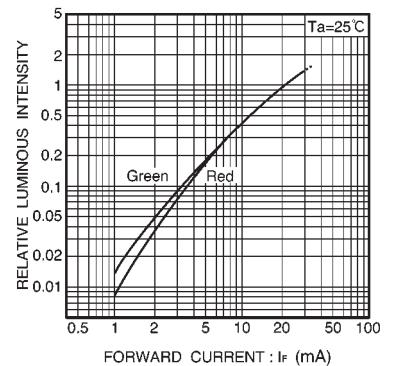

Fig. 5 Luminous intensity vs. forward current

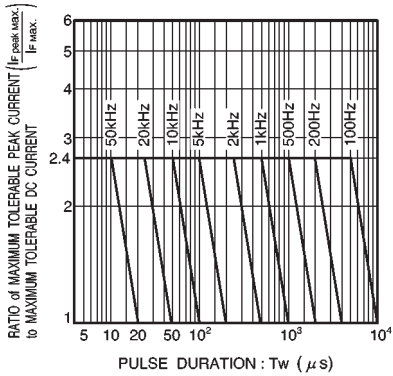

Fig. 6 Maximum tolerable peak current vs. pulse duration

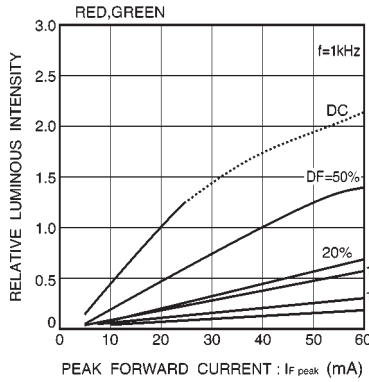

Fig. 7 Luminous intensity vs. peak forward current

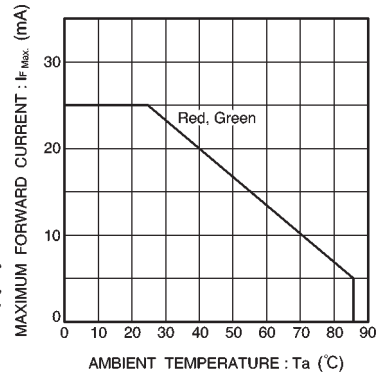

Fig. 8 Maximum forward current vs. ambient temperature

● Electrical characteristic curves 2 (SML-020MLT)

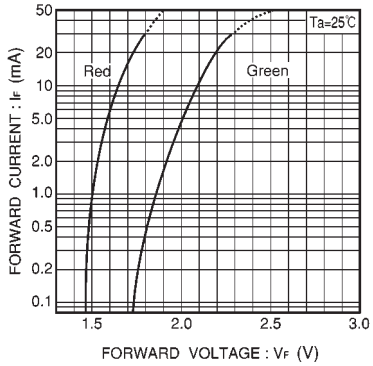

Fig. 9 Forward current vs. forward voltage

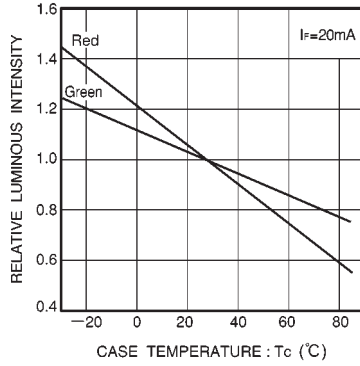

Fig. 10 Luminous intensity vs. case temperature

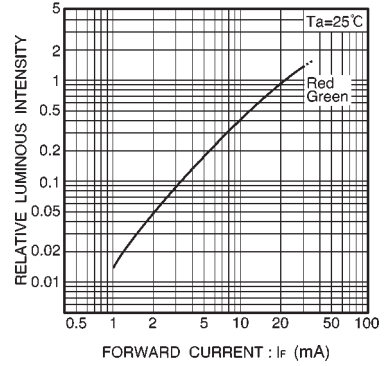

Fig. 11 Luminous intensity vs. forward current

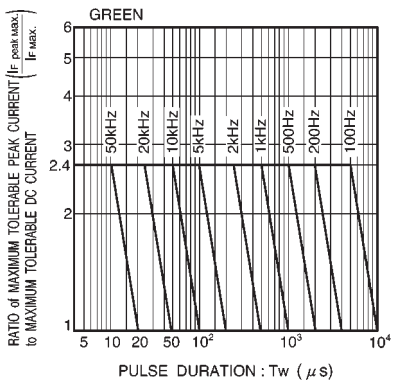

Fig. 12 Maximum tolerable peak current vs. pulse duration

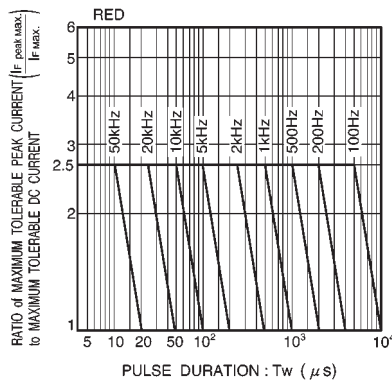

Fig. 13 Maximum tolerable peak current vs. pulse duration

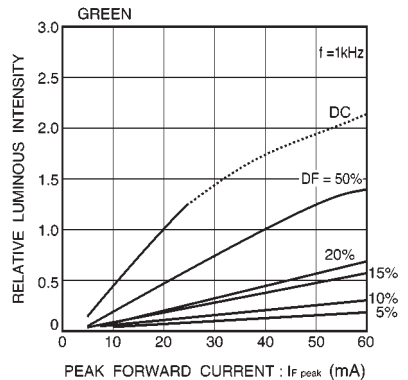

Fig. 14 Luminous intensity vs. peak forward current

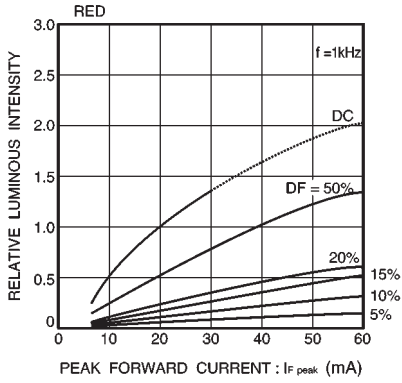

Fig. 15 Luminous intensity vs. peak forward current

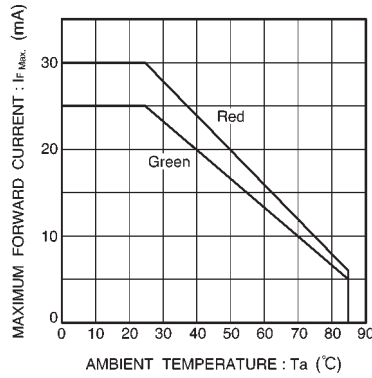

Fig. 16 Maximum forward current vs. ambient temperature