

## CSRS065V0-G/CSRS045V0-G/CSRS085V0-G

Working Voltage: 5Volts

RoHS Device

### Features

- Fast Reverse Recovery Time.
- Fast Turn on Time.
- Low Capacitance SMD Packages.
- 16kV IEC61000-4-2 capable.



### Mechanical Data

- Case: SOT-23-6 for CSRS065V0-G,
- SOT-143 for CSRS045V0-G,
- SOIC-8 for CSRS085V0-G.

### Circuit Diagram

CSRS065V0-G CSRS045V0-G CSRS085V0-G

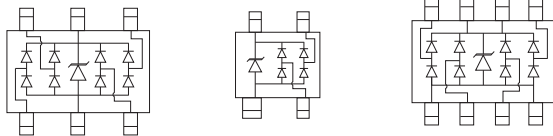

### Applications

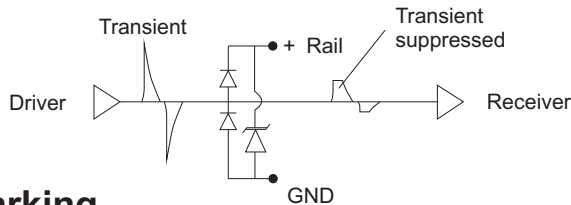

### Marking

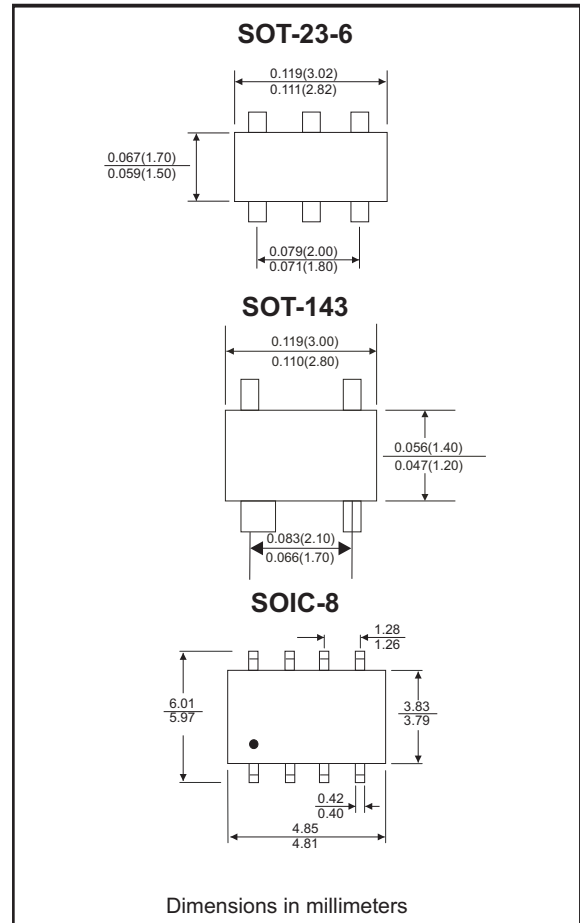
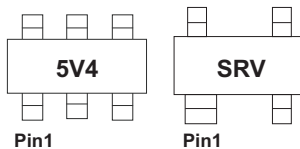

### Maximum Rating (at TA=25°C unless otherwise noted)

Parameter	Symbol	Value	Unit
Operating temperature	T <sub>J</sub>	-55 to +150	°C

### Electrical Characteristics (at TA=25°C unless otherwise noted)

Parameter	Conditions	Symbol	Min.	Max.	Unit
Forward voltage	I <sub>F</sub> =50mA	V <sub>F</sub>		1.2	V
Reverse stand-off voltage		V <sub>RWM</sub>		5	V
Diode breakdown voltage	I <sub>R</sub> =1μA	V <sub>BD</sub>	6		V
Reverse leakage current	V <sub>RWM</sub> =5V	I <sub>R</sub>		5	μA
Junction capacitance	f=1MHz, V <sub>R</sub> =0V, Line to ground f=1MHz, V <sub>R</sub> =0V, Line to Line	C <sub>T</sub>		5	pF
ESD capability	IEC 61000-4-2	ESD		16	kV
Peak pulse power	T <sub>P</sub> =8/20 μS	PPP		300	W

## Rating and Characteristic Curves (CSRS-G Series)

Fig.1 Pulse Power vs. Time

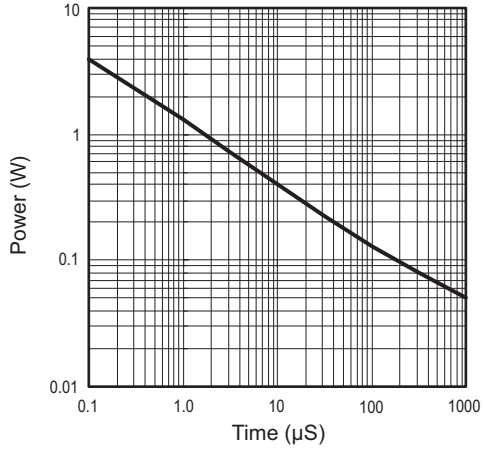

Fig.2 Power Derating

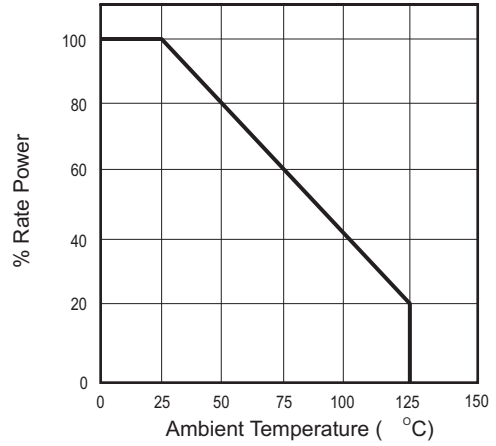

Fig.3 Pulse Waveform

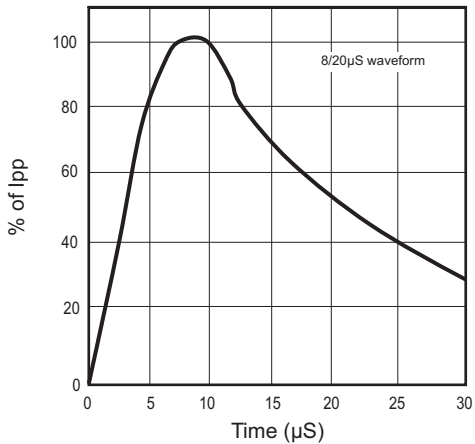

Fig.4 Clamp Voltage vs. Pulse Current

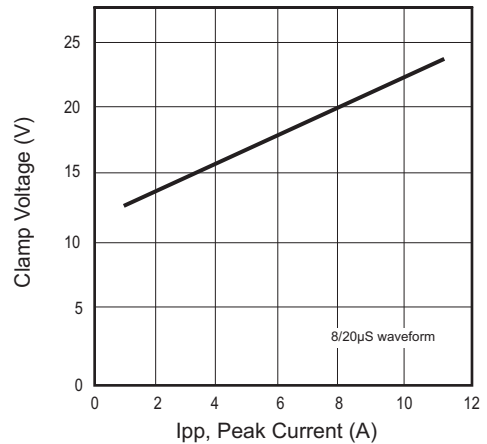

Fig.5 Forward Voltage vs. Forward Current

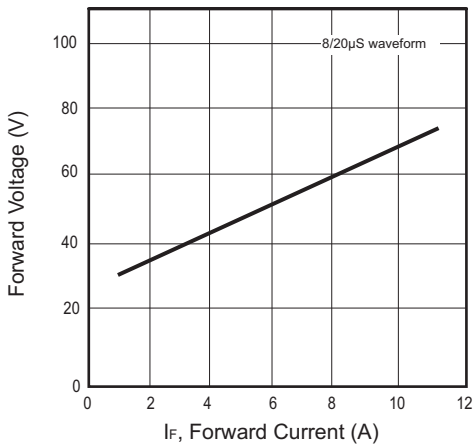
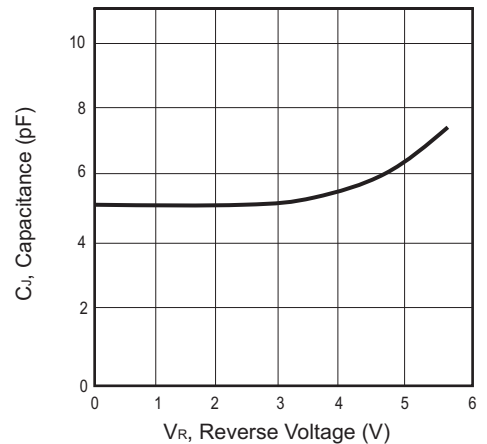
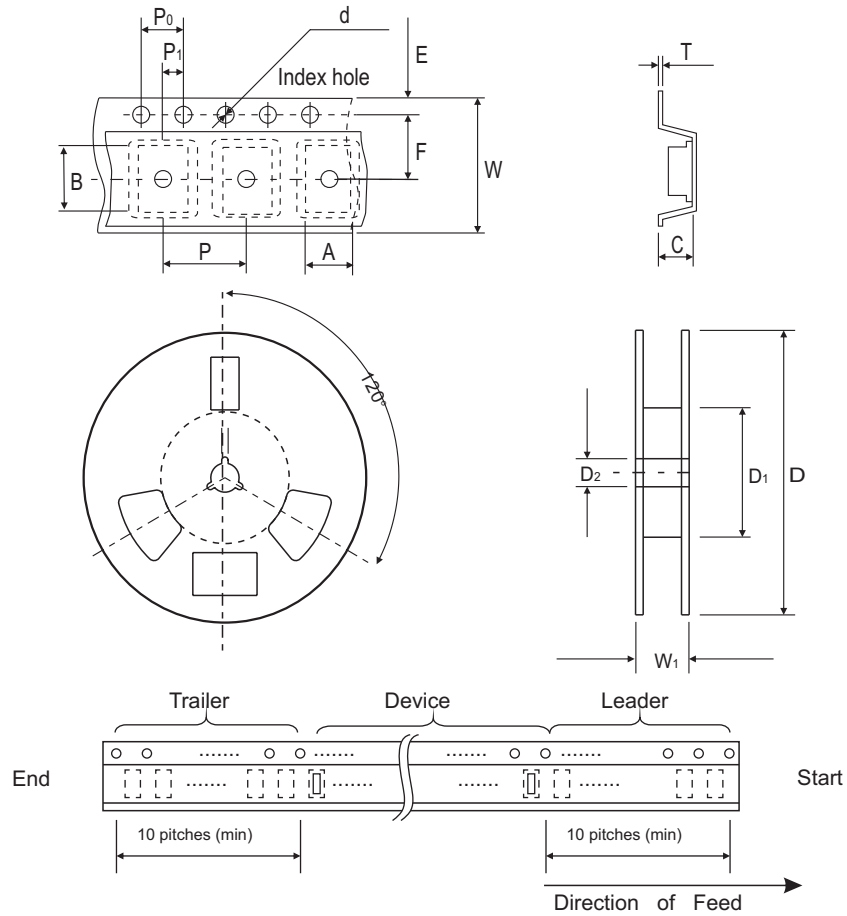

Fig.6 Capacitance vs. Reverse Voltage



## Reel Taping Specification



	SYMBOL	A	B	C	d	D	D <sub>1</sub>	D <sub>2</sub>
SOT-23-6	(mm)	3.17 ± 0.10	3.23 ± 0.10	1.37 ± 0.10	1.55 ± 0.10	178 ± 1	50.0 MIN.	13.0 ± 0.20
	(inch)	0.124 ± 0.004	0.127 ± 0.004	0.054 ± 0.004	0.061 ± 0.004	7.008 ± 0.040	1.969 MIN.	0.512 ± 0.008
SOT-143	(mm)	3.19 ± 0.10	2.80 ± 0.10	1.31 ± 0.20	1.55 ± 0.05	178 ± 1	50.0 MIN.	13.0 ± 0.20
	(inch)	0.126 ± 0.004	0.110 ± 0.004	0.052 ± 0.008	0.061 ± 0.002	7.008 ± 0.04	1.969 MIN.	0.512 ± 0.008
SOIC-8	(mm)	6.50 ± 0.10	5.30 ± 0.10	2.50 ± 0.20	1.50 ± 0.10	330 ± 1	50.0 MIN.	13.5 ± 1
	(inch)	0.256 ± 0.004	0.209 ± 0.004	0.098 ± 0.008	0.059 ± 0.004	12.992 ± 0.04	1.969 MIN.	0.531 ± 0.04

	SYMBOL	E	F	P	P <sub>0</sub>	P <sub>1</sub>	T	W	W <sub>1</sub>
SOT-23-6	(mm)	1.75 ± 0.10	3.50 ± 0.05	4.00 ± 0.10	4.00 ± 0.10	2.00 ± 0.05	0.22 ± 0.05	8.00 ± 0.30	14.4 MAX.
	(inch)	0.069 ± 0.004	0.138 ± 0.002	0.157 ± 0.004	0.157 ± 0.004	0.079 ± 0.002	0.008 ± 0.002	0.315 ± 0.012	0.567 MAX.
SOT-143	(mm)	1.75 ± 0.10	3.50 ± 0.05	4.00 ± 0.10	4.00 ± 0.10	2.00 ± 0.10	0.22 ± 0.05	8.00 ± 0.20	14.4 MAX.
	(inch)	0.069 ± 0.004	0.138 ± 0.002	0.157 ± 0.004	0.157 ± 0.004	0.079 ± 0.004	0.008 ± 0.002	0.315 ± 0.008	0.567 MAX.
SOIC-8	(mm)	1.75 ± 0.10	5.50 ± 0.05	4.00 ± 0.10	4.00 ± 0.10	2.00 ± 0.10	0.22 ± 0.05	12.0 ± 0.20	18.4 MAX.
	(inch)	0.069 ± 0.004	0.217 ± 0.002	0.157 ± 0.004	0.157 ± 0.004	0.079 ± 0.004	0.008 ± 0.002	0.472 ± 0.008	0.724 MAX.

## Suggested PAD Layout

SIZE	SOT-23-6		SOT-143		SOIC-8	
	(mm)	(inch)	(mm)	(inch)	(mm)	(inch)
A	1.10	0.043	0.70	0.028	2.40	0.094
B	0.60	0.024	1.40	0.055	0.70	0.028
C	0.95	0.037	2.41	0.095	1.27	0.050
D	2.50	0.098	0.80	0.031	2.50	0.098
E	3.60	0.142	3.60	0.142	7.30	0.287

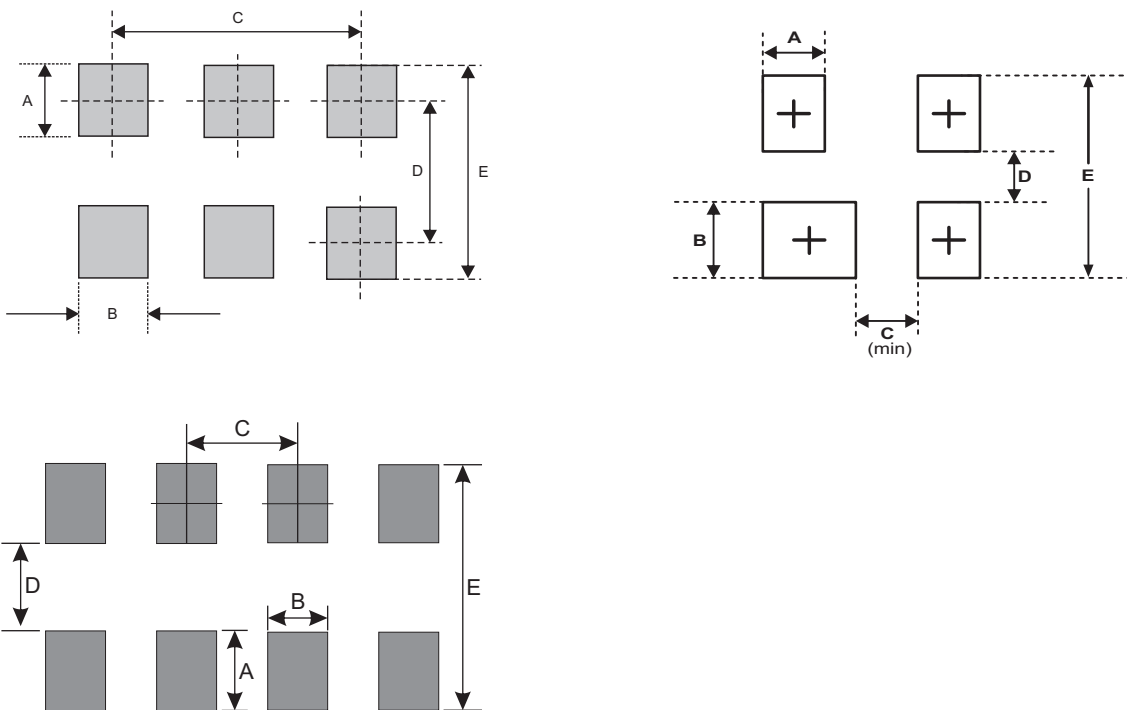

## Standard Package

Case Type	Qty per Reel	Reel Size
	(Pcs)	(inch)
SOT-23-6	3000	7
SOT-143	3000	7
SOIC-8	2500	13